

# Sensor/actuator cable - SAC-3P- 1,5-PUR/M12FR-2L



1694392

<https://www.phoenixcontact.com/pc/products/1694392>

Please be informed that the data shown in this PDF document is generated from our Online Catalog. Please find the complete data in the user documentation. Our General Terms of Use for Downloads are valid.



Sensor/actuator cable, 3-position, PUR halogen-free, black-gray RAL 7021, free cable end, on Socket angled M12, coding: A, with 2 LEDs, cable length: 1.5 m

## Your advantages

- Easy and safe: 100% electrically tested plug-in components
- Convenient: increased machine availability thanks to quick and easy diagnostics

## Commercial Data

Item number	1694392
Packing unit	1 pc
Minimum order quantity	1 pc
Sales Key	02
Product Key	BF1CBA
Catalog Page	Page 188 (C-2-2019)
GTIN	4017918178260
Weight per Piece (including packing)	44 g
Weight per Piece (excluding packing)	42.2 g
Customs tariff number	85444290
Country of origin	PL

1694392

<https://www.phoenixcontact.com/pc/products/1694392>

## Technical Data

### Product properties

Product type	Sensor/actuator cable
Number of positions	3
Application	Standard
No. of cable outlets	1
Shielded	no
Coding	A - standard

### Insulation characteristics

Overvoltage category	II
Degree of pollution	3

### Material specifications

Color Handle area	transparent
Flammability rating according to UL 94	HB
Sealing material	NBR
Material of grip body	TPU, hardly inflammable, self-extinguishing
Contact material	CuSn
Contact surface material	Ni/Au
Contact carrier material	TPU GF
Material for screw connection	Zinc die-cast, nickel-plated

### Electrical properties

Contact resistance	$\leq 5 \text{ m}\Omega$
Insulation resistance	$\geq 100 \text{ M}\Omega$
Nominal voltage $U_N$	24 V DC
Nominal current $I_N$	4 A
Protective circuit	unwired

### Mechanical properties

#### Mechanical data

Insertion/withdrawal cycles	$\geq 100$
-----------------------------	------------

### LED signaling

Status display	2 LEDs
Status display present	yes

### Connection data

#### Conductor connection

Tightening torque	0.4 Nm (M12 connector)
-------------------	------------------------

# Sensor/actuator cable - SAC-3P- 1,5-PUR/M12FR-2L



1694392

<https://www.phoenixcontact.com/pc/products/1694392>

## Connector

### Connection 1

Head design	free cable end
-------------	----------------

### Connection 2

Head design	Socket
Head cable outlet	angled
Head thread type	M12
Coding	A
Status indicator head	2 LEDs

## Cable / line

Cable length	1.5 m
--------------	-------

### PUR halogen-free black [PUR]

Dimensional drawing	
Cable weight	23 kg/km
UL AWM Style	20549
Number of positions	3
Shielded	no
Cable type	PUR halogen-free black [PUR]
Conductor structure signal line	42x 0.10 mm
AWG signal line	22
Conductor cross section	3x 0.34 mm <sup>2</sup> (Signal line)
Wire diameter incl. insulation	1.27 mm ±0.02 mm (Signal line)
External cable diameter	3.85 mm ±0.15 mm
Outer sheath, material	PUR
External sheath, color	black-gray RAL 7021
Conductor material	Bare Cu litz wires
Material wire insulation	PP
Single wire, color	brown, blue, black
Thickness, insulation	≥ 0.21 mm (Core insulation) approx. 0.5 mm (Outer cable sheath)
Overall twist	3 wires, twisted
Max. conductor resistance	max. 58 Ω/km (at 20 °C)
Insulation resistance	≥ 100 GΩ*km (at 20 °C)

# Sensor/actuator cable - SAC-3P- 1,5-PUR/M12FR-2L



1694392

<https://www.phoenixcontact.com/pc/products/1694392>

Nominal voltage, cable	≤ 300 V
Test voltage	≥ 3000 V
Smallest bending radius, fixed installation	19 mm
Smallest bending radius, movable installation	38 mm
Max. bending cycles	10000000
Halogen-free	in accordance with DIN VDE 0472 part 815
Flame resistance	in accordance with UL 758/1581 FT2 DIN EN 60332-2-2 (20 s)
Resistance to oil	in accordance with DIN EN 60811-2-1
Other resistance	Highly resistant to acids, alkaline solutions and solvents hydrolysis and microbe resistant partly UV-resistant in accordance with DIN EN ISO 4892-2-A
Special properties	Flexible cable conduit capable Silicone-free Free of substances which would hinder coating with paint or varnish
Ambient temperature (operation)	-40 °C ... 80 °C (cable, fixed installation) -25 °C ... 80 °C (Cable, flexible installation)

## Ambient conditions

Degree of protection	IP65 IP67 IP68
Ambient temperature (operation)	-25 °C ... 90 °C (Plug / socket)

## Standards and regulations

Standards/specifications	IEC 61076-2-101
--------------------------	-----------------

1694392

<https://www.phoenixcontact.com/pc/products/1694392>

## Drawings

Schematic diagram

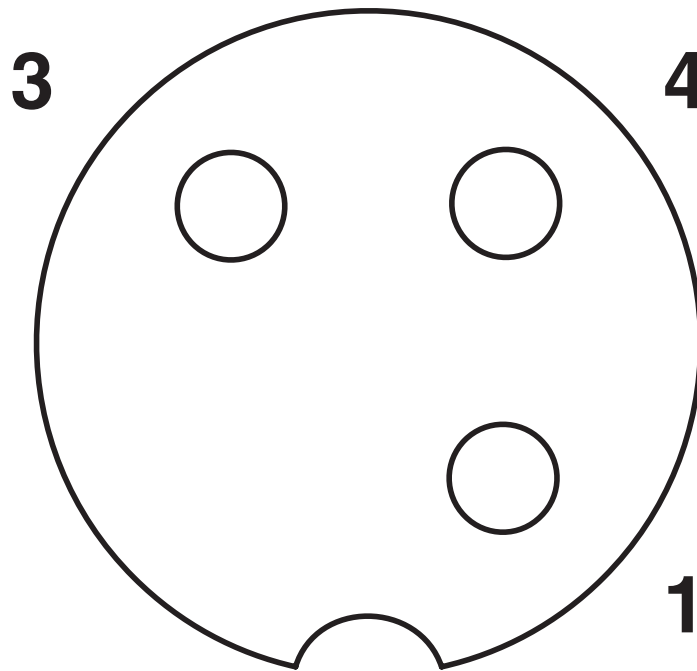

Pin assignment M12 socket, 3-pos., A-coded, view female side

Circuit diagram

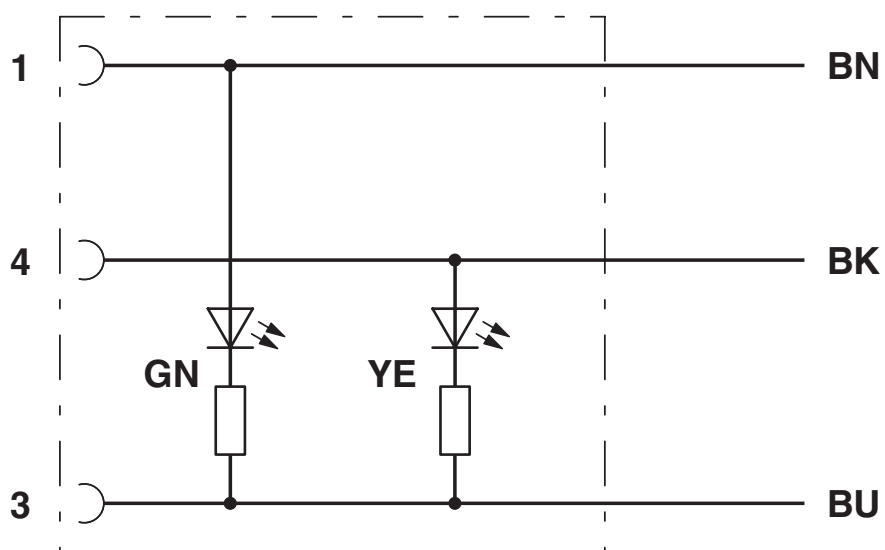

# Sensor/actuator cable - SAC-3P- 1,5-PUR/M12FR-2L

1694392

<https://www.phoenixcontact.com/pc/products/1694392>



Dimensional drawing

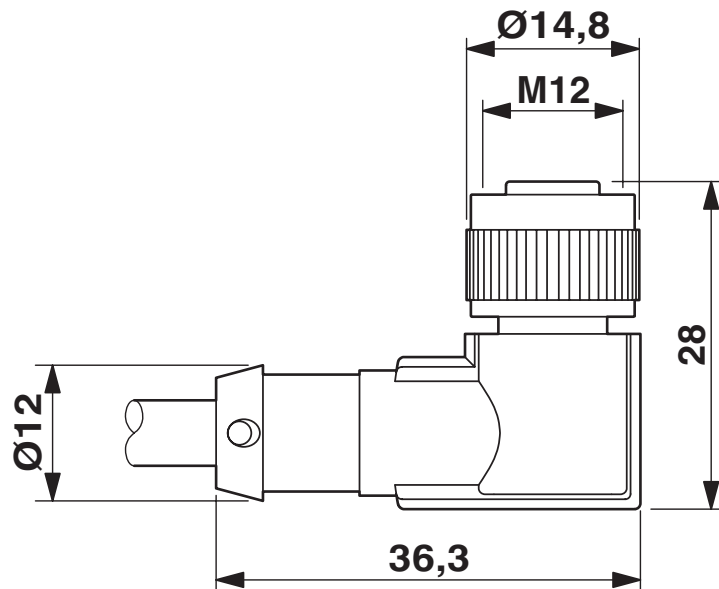

Socket M12 x 1, angled, with LED

# Sensor/actuator cable - SAC-3P- 1,5-PUR/M12FR-2L





1694392

<https://www.phoenixcontact.com/pc/products/1694392>

## Approvals

 <b>UL Listed</b> Approval ID: FILE E 221474				
	Nominal Voltage $U_N$	Nominal Current $I_N$	Cross Section AWG	Cross Section $\text{mm}^2$
	24 V	4 A	-	-

 <b>cUL Listed</b> Approval ID: FILE E 221474				
	Nominal Voltage $U_N$	Nominal Current $I_N$	Cross Section AWG	Cross Section $\text{mm}^2$
	24 V	4 A	-	-

 <b>EAC</b> Approval ID: RU D-DE.HB35.B.00387	
---	--

<b>cULus Listed</b>
---------------------

# Sensor/actuator cable - SAC-3P- 1,5-PUR/M12FR-2L



1694392

<https://www.phoenixcontact.com/pc/products/1694392>

## Classifications

### ECLASS

ECLASS-9.0	27060311
ECLASS-10.0.1	27060311
ECLASS-11.0	27060311

### ETIM

ETIM 8.0	EC001855
----------	----------

### UNSPSC

UNSPSC 21.0	26121600
-------------	----------

# Sensor/actuator cable - SAC-3P- 1,5-PUR/M12FR-2L



1694392

<https://www.phoenixcontact.com/pc/products/1694392>

## Environmental Product Compliance

China RoHS	Environmentally friendly use period: unlimited = EFUP-e
	No hazardous substances above threshold values

1694392

<https://www.phoenixcontact.com/pc/products/1694392>

## Accessories

### Insert label

Insert label - PABA WH/23 - 1013779

<https://www.phoenixcontact.com/pc/products/1013779>



Insert label, Strip, white, unlabeled, can be labeled with: CMS-P1-PLOTTER, mounting type: slide-on, cable diameter range: 1.5 ... 35 mm, lettering field size: 23 x 4 mm, Number of individual labels: 20

---

### Insert label

Insert label - PABA YE/23 - 1013782

<https://www.phoenixcontact.com/pc/products/1013782>



Insert label, Strip, yellow, unlabeled, can be labeled with: CMS-P1-PLOTTER, mounting type: slide-on, cable diameter range: 1.5 ... 35 mm, lettering field size: 23 x 4 mm, Number of individual labels: 20

1694392

<https://www.phoenixcontact.com/pc/products/1694392>

## Marker pen

Marker pen - B-STIFT - 1051993

<https://www.phoenixcontact.com/pc/products/1051993>



Marker pen, for manual labeling of unprinted Zack strips, smear-proof and waterproof, line thickness 0.5 mm

---

## Diagonal cutter

Diagonal cutter - CUTFOX-S VDE - 1212207

<https://www.phoenixcontact.com/pc/products/1212207>



Diagonal cutter for hard (piano wire) and soft wires, VDE 1000 V AC/1500 V DC tested

1694392

<https://www.phoenixcontact.com/pc/products/1694392>

## Stripping tool

Stripping tool - WIREFOX SAC-1 - 1212757

<https://www.phoenixcontact.com/pc/products/1212757>



Stripping pliers, for halogen-free sensor/actuator cables (SAC cables), with PUR and PVC insulation, from Ø of 3.2 to 4.4 mm, any stripping length

---

## Stripping tool

Stripping tool - WIREFOX SAC - 1212623

<https://www.phoenixcontact.com/pc/products/1212623>



Stripping pliers, for halogen-free sensor/actuator cables (SAC cables), with PUR and PVC insulation, from Ø of 4.4 to 7 mm, any stripping length

1694392

<https://www.phoenixcontact.com/pc/products/1694392>

## Stripping tool

Stripping tool - WIREFOX 10 - 1212150

<https://www.phoenixcontact.com/pc/products/1212150>



Stripping tool, for cables and conductors from 0.02 - 10 mm<sup>2</sup>, self-adjusting, stripping length of up to 18 mm, cutting capacity of up to 10 mm<sup>2</sup> stranded/1.5 mm<sup>2</sup> solid, replaceable stripping blade

---

## Protective hose adapter

Protective hose adapter - WP-CTA POM 13,0 BK - 1422884

<https://www.phoenixcontact.com/pc/products/1422884>



Protective hose adapter, for corrugated hoses with a nominal size of 13 (10 x 13), corrugated in parallel

1694392

<https://www.phoenixcontact.com/pc/products/1694392>

## Protective hose

Protective hose - WP-PA HF 13,0 BK - 3240681

<https://www.phoenixcontact.com/pc/products/3240681>



Protective hose, material: PA 6, UV-resistant: yes, flexible, degree of protection: IP68, color: black, flammability rating in acc. with UL 94: V0, inner diameter: 10 mm, Total length: 50 m

---

## Protective hose

Protective hose - WP-PA HF-HB 13,0 BK - 3240839

<https://www.phoenixcontact.com/pc/products/3240839>



Protective hose, material: PA 6, UV-resistant: yes, flexible, degree of protection: IP68, color: black, flammability rating in acc. with UL 94: HB, inner diameter: 10 mm, Total length: 50 m

# Sensor/actuator cable - SAC-3P- 1,5-PUR/M12FR-2L



1694392

<https://www.phoenixcontact.com/pc/products/1694392>

## Screw plug

Screw plug - PROT-M12 MS-PA-CHAIN - 1430899

<https://www.phoenixcontact.com/pc/products/1430899>

M12 sealing cap with fixing band, for sensor cables, for free M12 sockets



---

## Locking clip

Locking clip - SAC-M12-EXCLIP-F - 1558991

<https://www.phoenixcontact.com/pc/products/1558991>

Locking clip for the socket side of sensor/actuator cables with M12 connector and M12 connectors for assembly, for knurl diameter: 15 mm or for Allen key with a wrench size of 14 mm, prevents the disconnection of plug-in connections without tools



# Sensor/actuator cable - SAC-3P- 1,5-PUR/M12FR-2L



1694392

<https://www.phoenixcontact.com/pc/products/1694392>

## Torque screwdriver

Torque screwdriver - TSD 04 SAC - 1208429

<https://www.phoenixcontact.com/pc/products/1208429>



Torque screwdriver, with preset torque of 0.4 Nm and 4 mm hexagonal drive for M12 connectors

---

## Torque screwdriver

Torque screwdriver - TSD-M 1,2NM - 1212224

<https://www.phoenixcontact.com/pc/products/1212224>



Torque screw driver, accuracy as per EN ISO 6789 standard, adjustable from 0.3 - 1.2 Nm

# Sensor/actuator cable - SAC-3P- 1,5-PUR/M12FR-2L



1694392

<https://www.phoenixcontact.com/pc/products/1694392>

## Adapter insert

Adapter insert - TSD-M SAC-BIT ADAPTER - 1212600

<https://www.phoenixcontact.com/pc/products/1212600>



Adapter bit for TSD-M...torque tools, E6.3-1/4" drive with 4 mm hexagon to accommodate SAC bits

---

## Tool

Tool - SAC BIT M12-D15 - 1208432

<https://www.phoenixcontact.com/pc/products/1208432>



Nut for assembling sensor/actuator cables with M12 connector and M12 connectors for assembly, with a knurl diameter of 15 mm, for 4 mm hexagonal drive

---

Phoenix Contact 2023 © - all rights reserved

<https://www.phoenixcontact.com>

PHOENIX CONTACT GmbH & Co. KG

Flachsmarktstraße 8

D-32825 Blomberg

+49 (0) 5235-3 00

[info@phoenixcontact.com](mailto:info@phoenixcontact.com)