

## OMNIMATE Signal - series BL/SL 3.50 BL 3.50/09/180LH SN BK BX

**Weidmüller Interface GmbH & Co. KG**  
Klingenbergstraße 26  
D-32758 Detmold  
Germany  
Fon: +49 5231 14-0  
Fax: +49 5231 14-292083  
www.weidmueller.com

### Product image

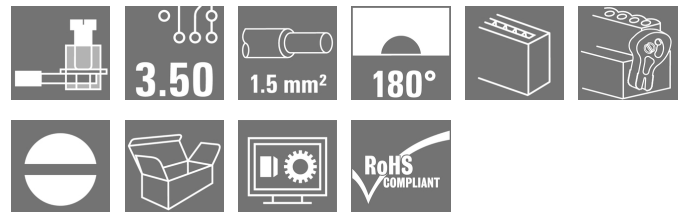

Similar to illustration

Female connectors with clamping yoke screw system for connecting conductors at 3.50 mm pitch. They provide space for labelling and can be coded.

### General ordering data

Type	BL 3.50/09/180LH SN BK BX
Order No.	<a href="#">1687950000</a>
Version	PCB plug-in connector, female plug, 3.50 mm, Number of poles: 9, 180°, Clamping yoke connection, Clamping range, max. : 1.5 mm², Box
GTIN (EAN)	4008190853501
Qty.	48 pc(s).
Product data	IEC: 320 V / 17 A / 0.2 - 1.5 mm² UL: 300 V / 10 A / AWG 28 - AWG 14
Packaging	Box

Creation date April 12, 2020 10:33:34 PM CEST

**OMNIMATE Signal - series BL/SL 3.50  
BL 3.50/09/180LH SN BK BX**

**Weidmüller Interface GmbH & Co. KG**  
Klingenbergstraße 26  
D-32758 Detmold  
Germany  
Fon: +49 5231 14-0  
Fax: +49 5231 14-292083  
www.weidmueller.com

**Technical data****Dimensions and weights**

Width	38 mm	Width (inches)	1.496 inch
Height	14.9 mm	Height (inches)	0.587 inch
Depth	29.5 mm	Depth (inches)	1.161 inch
Net weight	9.34 g		

**System Parameters**

Product family	OMNIMATE Signal - series BL/SL 3.50	Type of connection	Field connection
Wire connection method	Clamping yoke connection	Pitch in mm (P)	3.5 mm
Pitch in inches (P)	0.138 inch	Conductor outlet direction	180°
Number of poles	9	L1 in mm	28 mm
L1 in inches	1.102 inch	Number of rows	1
Pin series quantity	1	Rated cross-section	1.5 mm <sup>2</sup>
Touch-safe protection acc. to DIN VDE 57 106	Safe from finger touch	Touch-safe protection acc. to DIN VDE 0470	IP 20
Volume resistance	≤ 5mΩ	Can be coded	Yes
Stripping length	6 mm	Tightening torque, min.	0.2 Nm
Tightening torque, max.	0.25 Nm	Clamping screw	M 2
Screwdriver blade	0.4 x 2.5	Screwdriver blade standard	DIN 5264
Plugging cycles	25	Plugging force/pole, max.	7 N
Pulling force/pole, max.	5 N		

**Material data**

Insulating material	PBT	Colour	black
Colour chart (similar)	RAL 9011	Insulating material group	IIIa
Comparative Tracking Index (CTI)	≥ 200	Insulation strength	≥ 10 <sup>8</sup> Ω
UL 94 flammability rating	V-0	GWFI	960 °C
Contact material	Copper alloy	Contact surface	tinned
Layer structure of plug contact	4-8 μm Sn hot-dip tinned	Storage temperature, min.	-25 °C
Storage temperature, max.	50 °C	Max. relative humidity during storage	70 %
Operating temperature, min.	-50 °C	Operating temperature, max.	100 °C
Temperature range, installation, min.	-30 °C	Temperature range, installation, max.	100 °C

**Conductors suitable for connection**

Clamping range, min.	0.08 mm <sup>2</sup>
Clamping range, max.	1.5 mm <sup>2</sup>
Wire connection cross section AWG, min.	AWG 28
Wire connection cross section AWG, max.	AWG 14
Solid, min. H05(07) V-U	0.2 mm <sup>2</sup>
Solid, max. H05(07) V-U	1.5 mm <sup>2</sup>
Flexible, min. H05(07) V-K	0.2 mm <sup>2</sup>
Flexible, max. H05(07) V-K	1.5 mm <sup>2</sup>
w. plastic collar ferrule, DIN 46228 pt 4, 0.2 mm <sup>2</sup> min.	
w. plastic collar ferrule, DIN 46228 pt 4, 1.5 mm <sup>2</sup> max.	
w. wire end ferrule, DIN 46228 pt 1, 0.2 mm <sup>2</sup> min.	
w. wire end ferrule, DIN 46228 pt 1, 1.5 mm <sup>2</sup> max.	

Creation date April 12, 2020 10:33:34 PM CEST

**OMNIMATE Signal - series BL/SL 3.50**  
**BL 3.50/09/180LH SN BK BX**

**Weidmüller Interface GmbH & Co. KG**  
 Klingenbergstraße 26  
 D-32758 Detmold  
 Germany  
 Fon: +49 5231 14-0  
 Fax: +49 5231 14-292083  
 www.weidmueller.com

**Technical data**

Plug gauge in accordance with EN 60999 a x b; ø	2.4 mm x 1.5 mm		
Clampable conductor	Cross-section for conductor connection	Type	fine-wired
		nominal	0.5 mm <sup>2</sup>
wire end ferrule	Stripping length	nominal	8 mm
		Recommended wire-end ferrule	<a href="#">H0.5/12 OR</a>
	Stripping length	nominal	6 mm
		Recommended wire-end ferrule	<a href="#">H0.5/6</a>
Cross-section for conductor connection	Type	fine-wired	
	nominal	0.75 mm <sup>2</sup>	
wire end ferrule	Stripping length	nominal	8 mm
		Recommended wire-end ferrule	<a href="#">H0.75/12 W</a>
	Stripping length	nominal	6 mm
		Recommended wire-end ferrule	<a href="#">H0.75/6</a>
Cross-section for conductor connection	Type	fine-wired	
	nominal	1 mm <sup>2</sup>	
wire end ferrule	Stripping length	nominal	8 mm
		Recommended wire-end ferrule	<a href="#">H1.0/12 GE</a>
	Stripping length	nominal	6 mm
		Recommended wire-end ferrule	<a href="#">H1.0/6</a>
Cross-section for conductor connection	Type	fine-wired	
	nominal	0.25 mm <sup>2</sup>	
wire end ferrule	Stripping length	nominal	8 mm
		Recommended wire-end ferrule	<a href="#">H0.25/10 HBL</a>
	Stripping length	nominal	5 mm
		Recommended wire-end ferrule	<a href="#">H0.25/5</a>
Cross-section for conductor connection	Type	fine-wired	
	nominal	0.34 mm <sup>2</sup>	
wire end ferrule	Stripping length	nominal	8 mm
	Recommended wire-end ferrule	<a href="#">H0.34/10 TK</a>	
Reference text	The outside diameter of the plastic collar should not be larger than the pitch (P). Length of ferrules is to be chosen depending on the product and the rated voltage.		
Max. clamping range	1.5 mm <sup>2</sup>		

**Rated data acc. to IEC**

tested acc. to standard	IEC 60664-1, IEC 61984	Rated current, min. number of poles (Tu=20°C)	17 A
Rated current, max. number of poles (Tu=20°C)	12 A	Rated current, min. number of poles (Tu=40°C)	14.5 A
Rated current, max. number of poles (Tu=40°C)	10 A	Rated voltage for surge voltage class / pollution degree II/2	320 V
Rated voltage for surge voltage class / pollution degree III/2	160 V	Rated voltage for surge voltage class / pollution degree III/3	160 V
Rated impulse voltage for surge voltage class/ pollution degree II/2	320 V	Rated impulse voltage for surge voltage class/ pollution degree III/2	160 V
Rated impulse voltage for surge voltage class/ contamination degree III/3	160 V	Short-time withstand current resistance	3 x 1s with 100 A

**OMNIMATE Signal - series BL/SL 3.50  
BL 3.50/09/180LH SN BK BX**

**Weidmüller Interface GmbH & Co. KG**  
Klingenbergstraße 26  
D-32758 Detmold  
Germany  
Fon: +49 5231 14-0  
Fax: +49 5231 14-292083  
www.weidmueller.com

**Technical data****Rated data acc. to CSA**

Rated voltage (Use group B / CSA)	300 V	Rated voltage (Use group D / CSA)	300 V
Rated current (Use group B / CSA)	10 A	Rated current (Use group D / CSA)	10 A
Wire cross-section, AWG, min.	AWG 28	Wire cross-section, AWG, max.	AWG 14

**Rated data acc. to UL 1059**

Institute (UR)		Certificate No. (UR)	E60693
Rated voltage (Use group B / UL 1059)	300 V	Rated voltage (Use group D / UL 1059)	300 V
Rated current (Use group B / UL 1059)	10 A	Rated current (Use group D / UL 1059)	10 A
Wire cross-section, AWG, min.	AWG 28	Wire cross-section, AWG, max.	AWG 14
Reference to approval values	Specifications are maximum values, details - see approval certificate.		

**Packing**

Packaging	Box	VPE length	67 mm
VPE width	106 mm	VPE height	136 mm

**Classifications**

ETIM 6.0	EC002638	ETIM 7.0	EC002638
eClass 9.0	27-44-03-09	eClass 9.1	27-44-03-09
eClass 10.0	27-44-03-09	UNSPSC	30-21-18-10

**Notes**

Notes	<ul style="list-style-type: none"> <li>• Additional colours on request</li> <li>• Gold-plated contact surfaces on request</li> <li>• Rated current related to rated cross-section &amp; min. No. of poles.</li> <li>• Max. outer diameter of the conductor: 2.9 mm</li> <li>• Wire end ferrule without plastic collar to DIN 46228/1</li> <li>• Wire end ferrule with plastic collar to DIN 46228/4</li> <li>• P on drawing = pitch</li> <li>• Rated data refer only to the component itself. Clearance and creepage distances to other components are to be designed in accordance with the relevant application standards.</li> </ul>
IPC conformity	Conformity: The products are developed, manufactured and delivered according international recognized standards and norms and comply with the assured properties in the data sheet resp. fulfill decorative properties in accordance with IPC-A-610 "Class 2". Further claims on the products can be evaluated on request.

**Data sheet**

**OMNIMATE Signal - series BL/SL 3.50  
BL 3.50/09/180LH SN BK BX**

**Weidmüller Interface GmbH & Co. KG**  
Klingenbergstraße 26  
D-32758 Detmold  
Germany  
Fon: +49 5231 14-0  
Fax: +49 5231 14-292083  
www.weidmueller.com

**Technical data**

**Approvals**

Approvals



ROHS

Conform

**Downloads**

Approval/Certificate/Document of  
Conformity

[Declaration of the Manufacturer](#)

Brochure/Catalogue

- [FL DRIVES EN](#)
- [MB DEVICE MANUF. EN](#)
- [FL DRIVES DE](#)
- [CAT 2 PORTFOLIOGUIDE EN](#)
- [FL BUILDING SAFETY EN](#)
- [FL APPL LED LIGHTING EN](#)
- [FLIndustr.CONTROLS EN](#)
- [FL MACHINE SAFETY EN](#)
- [FL HEATING ELECTR EN](#)
- [FL APPL INVERTER EN](#)
- [FL\\_BASE\\_STATION\\_EN](#)
- [FL ELEVATOR EN](#)
- [FL POWER SUPPLY EN](#)
- [FL 72H SAMPLE SER EN](#)
- [PO OMNIMATE EN](#)

Engineering Data

[EPLAN\\_WSCAD](#)

Engineering Data

[STEP](#)

Product Change Notification

[Change of Material LR 3.50 - DE](#)  
[Change of Material LR 3.50 - EN](#)

**OMNIMATE Signal - series BL/SL 3.50  
BL 3.50/09/180LH SN BK BX**

**Weidmüller Interface GmbH & Co. KG**  
Klingenbergstraße 26  
D-32758 Detmold  
Germany  
Fon: +49 5231 14-0  
Fax: +49 5231 14-292083  
www.weidmueller.com

**Drawings**

**Dimensional drawing**

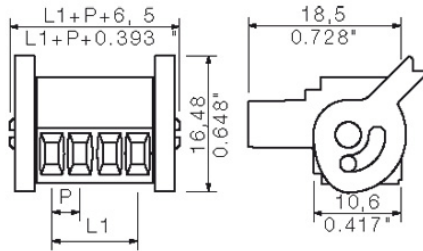

**Graph**

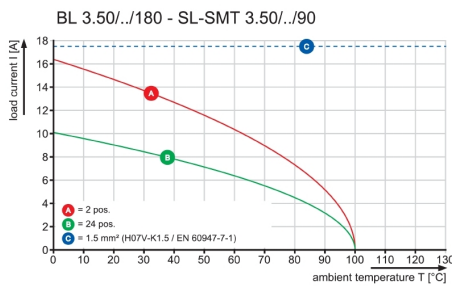

**Graph**

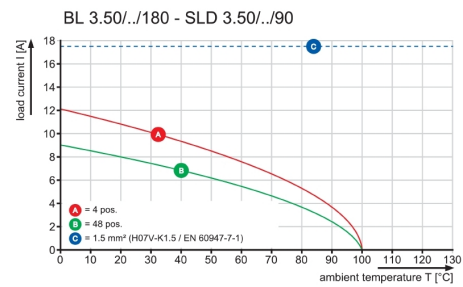

**Graph**

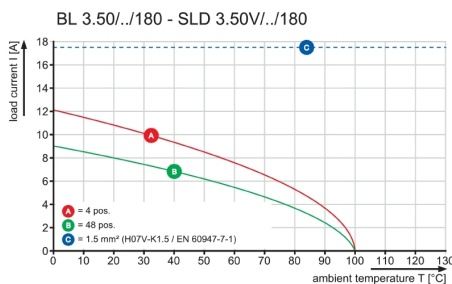

**Graph**



DIE DEUTSCHE VERSION IST VERBINDLICH  
THE GERMAN VERSION IS BINDING

WEITERGABE SOWIE VERVIELFÄLTIGUNG DIESES DOKUMENTS, VERWERTUNG UND MITTEILUNG SEINES INHALTS SIND VERBOTEN, SOWEIT NICHT AUSDRUECKLICH GESTATTET.  
 ZUWIDERHANDLUNGEN VERPFLICHTEN ZU SCHADENERSATZ. ALLE RECHTE FUER DEN FALL DER PATENT-, GEBRAUCHSMUSTER- ODER GESCHMACKSMUSTERENTRAGUNG VORBEHALTEN.  
 THE REPRODUCTION, DISTRIBUTION AND UTILIZATION OF THIS DOCUMENT AS WELL AS THE COMMUNICATION OF ITS CONTENTS TO OTHERS WITHOUT EXPLICIT AUTHORIZATION IS PROHIBITED.  
 OFFENDERS WILL BE HELD LIABLE FOR THE PAYMENT OF DAMAGES. WEIDMUELLER EXCLUSIVELY RESERVES THE RIGHT TO FILE FOR PATENTS, UTILITY MODELS OR DESIGNS.  
 © WEIDMUELLER INTERFACE GmbH & Co.KG

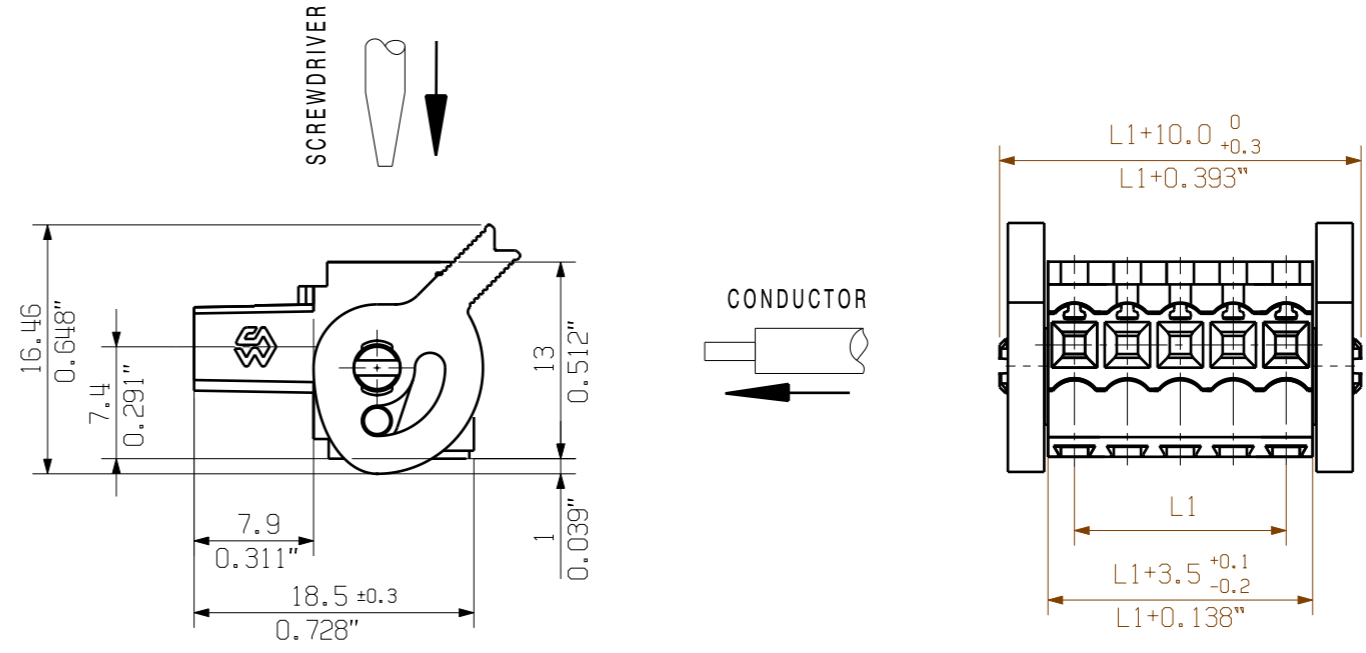

24	80,50	3,169
23	77,00	3,031
22	73,50	2,894
21	70,00	2,756
20	66,50	2,618
19	63,00	2,480
18	59,50	2,343
17	56,00	2,205
16	52,50	2,067
15	49,00	1,929
14	45,50	1,791
13	42,00	1,654
12	38,50	1,516
11	35,00	1,378
10	31,50	1,240
9	28,00	1,102
8	24,50	0,965
7	21,00	0,827
6	17,50	0,689
5	14,00	0,551
4	10,50	0,413
3	7,00	0,276
2	3,50	0,138
n	L1 [mm]	L1 [inch]

For the mounting of PCBs, it should be noted that the rated data given in the catalogue relates only to the connection elements. The necessary creepage and clearance paths must be observed in connection with the respective applicant in accordance to VDE 0110. The current-carrying capacity and pitch tolerance is to be determined according to DIN IEC 326 part 3 very fine.

Weidmüller PCB components are tested to the DIN VDE 0627 standard, and are valid for its field of application. Provided that the components are used to the intended purpose, all requirements with respect to the occurring of electrical, mechanical, thermic and corrosive stress will be satisfied.

SHOWN: BL 3.50/04/180/LH...

	DIN ISO 2768-m	69114/0 20.03.13 HELIS_MA 01		CAT.NO.:	
		<b>MODIFICATION</b>		<b>Weidmüller</b>	
SCALE: 2/1 SUPERSEDES:	DRAWN: 21.07.2009 RESPONSIBLE:	DATE: 04.04.2013 CHECKED:	NAME: HELIS_MA LANG_T HECKERT_M	<b>C 22682 11</b> DRAWING NO. ISSUE NO. SHEET 01 OF 02 SHEETS	
PRODUCT FILE: BL 3.50			<b>BL 3.50/./180/ L(H/R)</b> BUCHSENLEISTE SOCKET BLOCK		
			7382		