

1670326-1 ✓ ACTIVE

AMP | Sensor Flat Contact System

TE Internal #: 1670326-1

Sensor Flat Contact System, Automotive Terminals, Receptacle,  
Mating Tab Width 1.5 mm [.059 in], Tab Thickness .024 in [.6 mm],  
18 – 17 AWG Wire Size

[View on TE.com >](#)



Terminals & Splices > Automotive Terminals > AMP MCP, SFC, RECEPTACLE



Terminal Type: **Receptacle**

Mating Tab Width: 1.5 mm [.059 in]

Mating Tab Thickness: .6 mm [.024 in]

Terminal Transmits: 0 – 24 A (Low Power)

Wire Size: 18 – 17 AWG

[All AMP MCP, SFC, RECEPTACLE \(23\)](#)

## Features

### Product Type Features

Receptacle Style	180°
Sealable	No
Primary Locking Feature	Clean Body

### Contact Features

Contact Fabrication	Stamped & Formed
Typical Current Rating	12 A
Crimp Type	F-Crimp
Terminal Type	Receptacle
Mating Tab Width	1.5 mm [.059 in]
Mating Tab Thickness	.6 mm [.024 in]
Interface Plating	Gold (Au)
Contact Termination Area Plating Material	Gold (Au)



### Termination Features

Termination Method to Wire & Cable	Crimp
Product Terminates To	Wire

### Dimensions

Wire Size	.75 – 1 mm <sup>2</sup>
Wire Size Search	17 AWG, 18 AWG
Wire Insulation Diameter	1.7 – 2.1 mm [.067 – .083 in]

### Usage Conditions

Insulation Option	Uninsulated
Operating Temperature (Max)	80 °C, 85 °C, 90 °C, 100 °C, 105 °C, 110 °C, 120 °C, 125 °C, 130 °C, 140 °C, 145 °C, 150 °C [176 °F][185 °F][194 °F][212 °F][221 °F][230 °F][248 °F][257 °F][266 °F][284 °F][293 °F][302 °F]
Operating Temperature Range	-40 – 150 °C [-40 – 302 °F]

### Operation/Application

Compatible With Wire Base Material	Copper
------------------------------------	--------

### Industry Standards

Agency/Standard	LV214
-----------------	-------

### Packaging Features

Packaging Method	Reel
Packaging Quantity	5500

### Other

Terminal Transmits	0 – 24 A (Low Power)
--------------------	----------------------

### Product Compliance

[For compliance documentation, visit the product page on TE.com>](#)

EU RoHS Directive 2011/65/EU	Compliant
EU ELV Directive 2000/53/EC	Compliant
China RoHS 2 Directive MIIT Order No 32, 2016	No Restricted Materials Above Threshold
EU REACH Regulation (EC) No. 1907/2006	Current ECHA Candidate List: JAN 2022 (223) Candidate List Declared Against: JAN 2022 (223) Does not contain REACH SVHC



Halogen Content	Low Halogen - Br, Cl, F, I < 900 ppm per homogenous material. Also BFR/CFR/PVC Free
Solder Process Capability	Not applicable for solder process capability

**Product Compliance Disclaimer**

This information is provided based on reasonable inquiry of our suppliers and represents our current actual knowledge based on the information they provided. This information is subject to change. The part numbers that TE has identified as EU RoHS compliant have a maximum concentration of 0.1% by weight in homogenous materials for lead, hexavalent chromium, mercury, PBB, PBDE, DBP, BBP, DEHP, DIBP, and 0.01% for cadmium, or qualify for an exemption to these limits as defined in the Annexes of Directive 2011/65/EU (RoHS2). Finished electrical and electronic equipment products will be CE marked as required by Directive 2011/65/EU. Components may not be CE marked. Additionally, the part numbers that TE has identified as EU ELV compliant have a maximum concentration of 0.1% by weight in homogenous materials for lead, hexavalent chromium, and mercury, and 0.01% for cadmium, or qualify for an exemption to these limits as defined in the Annexes of Directive 2000/53/EC (ELV). Regarding the REACH Regulation, the information TE provides on SVHC in articles for this part number is based on the latest European Chemicals Agency (ECHA) 'Guidance on requirements for substances in articles' posted at this URL: <https://echa.europa.eu/guidance-documents/guidance-on-reach>

## Compatible Parts

 <p>TE Part # 1801178-1 3W RECEPTACLE HP CONNECTOR BLACK</p>	 <p>TE Part # 1801176-1 2W RECEPTACLE HPSL CONNECTOR BLACK</p>	 <p>TE Part # 2305570-1 TERMINAL CUTTER, SIDE FEED</p>	 <p>TE Part # 1-1801178-3 3W RECEPTACLE HP CONNECTOR GREY</p>
 <p>TE Part # 1801174-1 2W TAB HP CONNECTOR BLACK</p>	 <p>TE Part # 1-1801175-1 2W RECEPTACLE HP CONNECTOR BLACK</p>	 <p>TE Part # 1801175-5 2W RECEPTACLE HP CONNECTOR GREEN</p>	 <p>TE Part # 1801174-4 2W TAB HP CONNECTOR YELLOW</p>
 <p>TE Part # 1801177-4 3W TAB CONNECTOR HP YELLOW</p>	 <p>TE Part # 1801175-7 2W RECEPTACLE HP CONNECTOR WHITE</p>	 <p>TE Part # 1801177-1 3W TAB CONNECTOR HP BLACK</p>	 <p>TE Part # 1801179-1 3W RECEPTACLE HPSL CONNECTOR BLACK</p>



Also in the Series | **Sensor Flat Contact System**

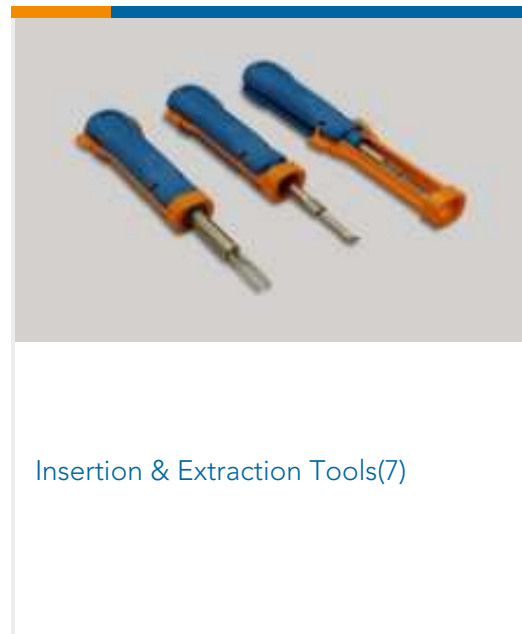
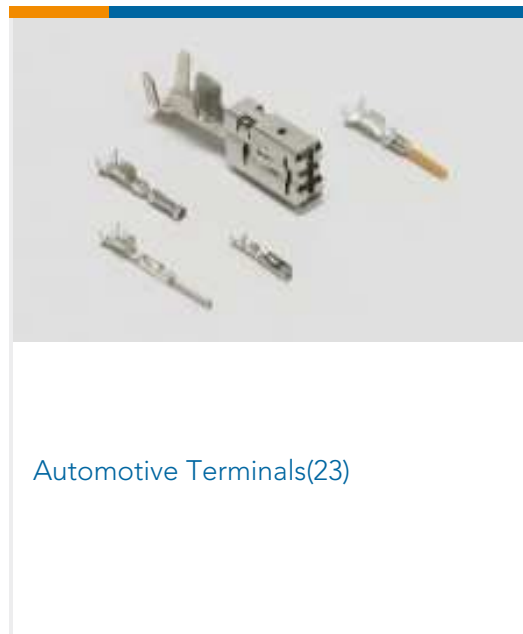
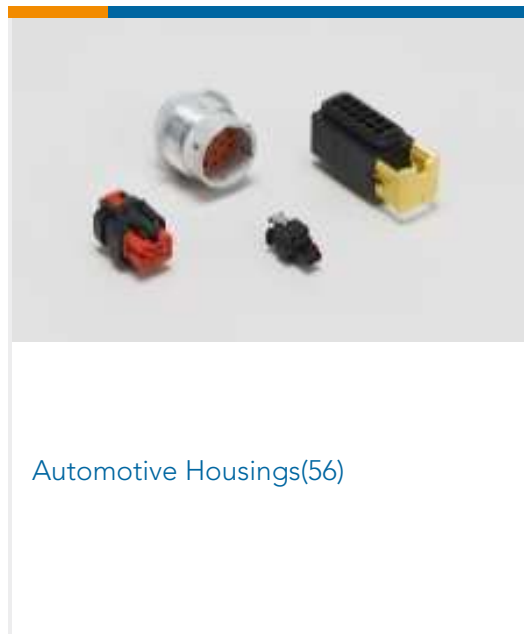
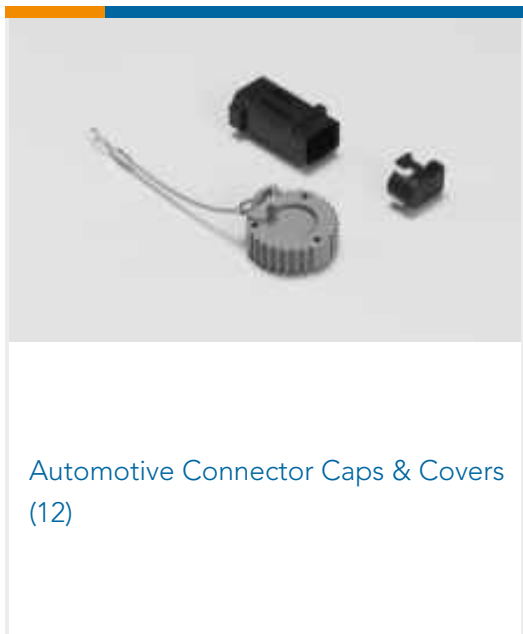

Customers Also Bought

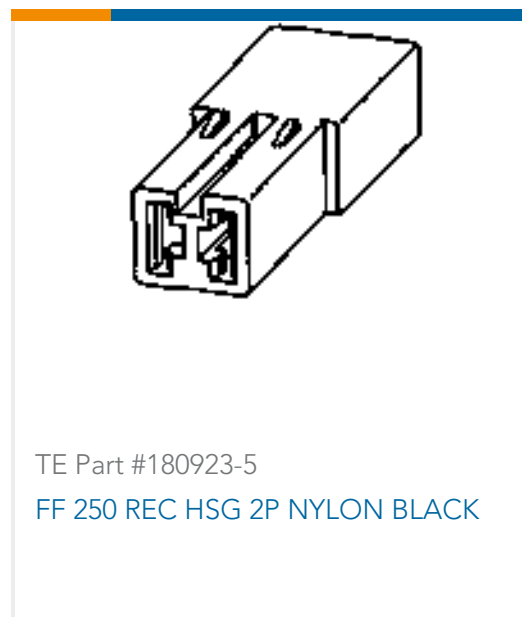

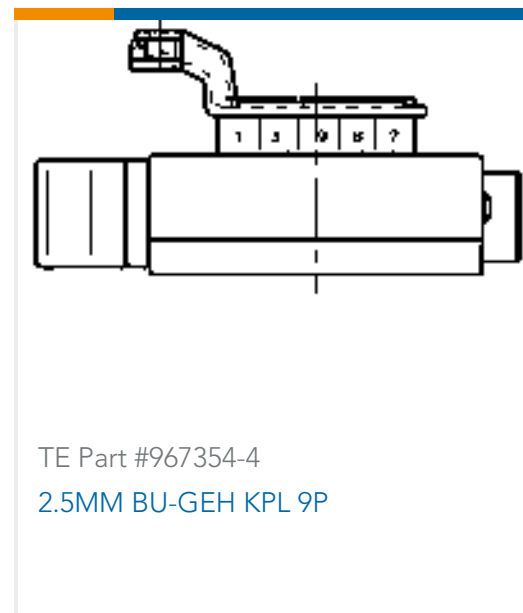
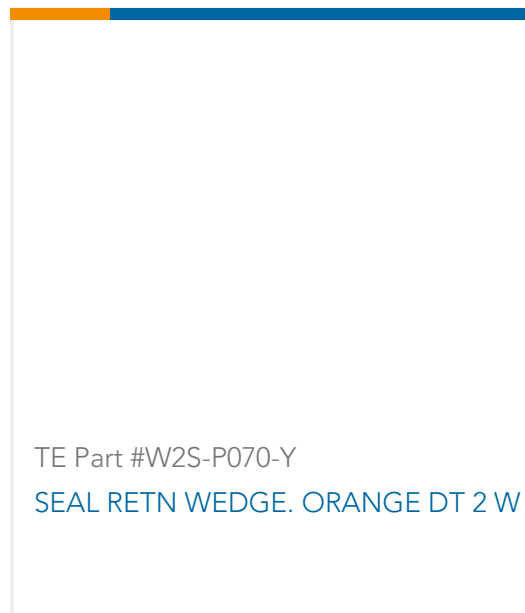

## Documents

### Product Drawings

[1.5MM SFC,CONTACT](#)

German

### CAD Files

[3D PDF](#)

3D

Customer View Model

[ENG\\_CVM\\_CVM\\_1670326-1\\_B.2d\\_dxf.zip](#)

English

Customer View Model

[ENG\\_CVM\\_CVM\\_1670326-1\\_B.3d\\_igs.zip](#)

English

Customer View Model

[ENG\\_CVM\\_CVM\\_1670326-1\\_B.3d\\_stp.zip](#)

English

By downloading the CAD file I accept and agree to the [Terms and Conditions](#) of use.

### Product Specifications

[Application Specification](#)

German

[Application Specification](#)

German

### Product Environmental Compliance

[Product Compliance](#)

English

[Product Compliance](#)

English