

1645570-1 ✓ ACTIVE

Z-PACK | Z-PACK 2mm HM

TE Internal #: 1645570-1

Hard Metric Backplane Connectors, PCB Mount Receptacle, 1 Gb/s, 6 Column, 12 Row, Traditional Backplane, 72 Position, Z-PACK 2mm HM

[View on TE.com >](#)



Connectors > PCB Connectors > Backplane Connectors > Hard Metric Backplane Connectors

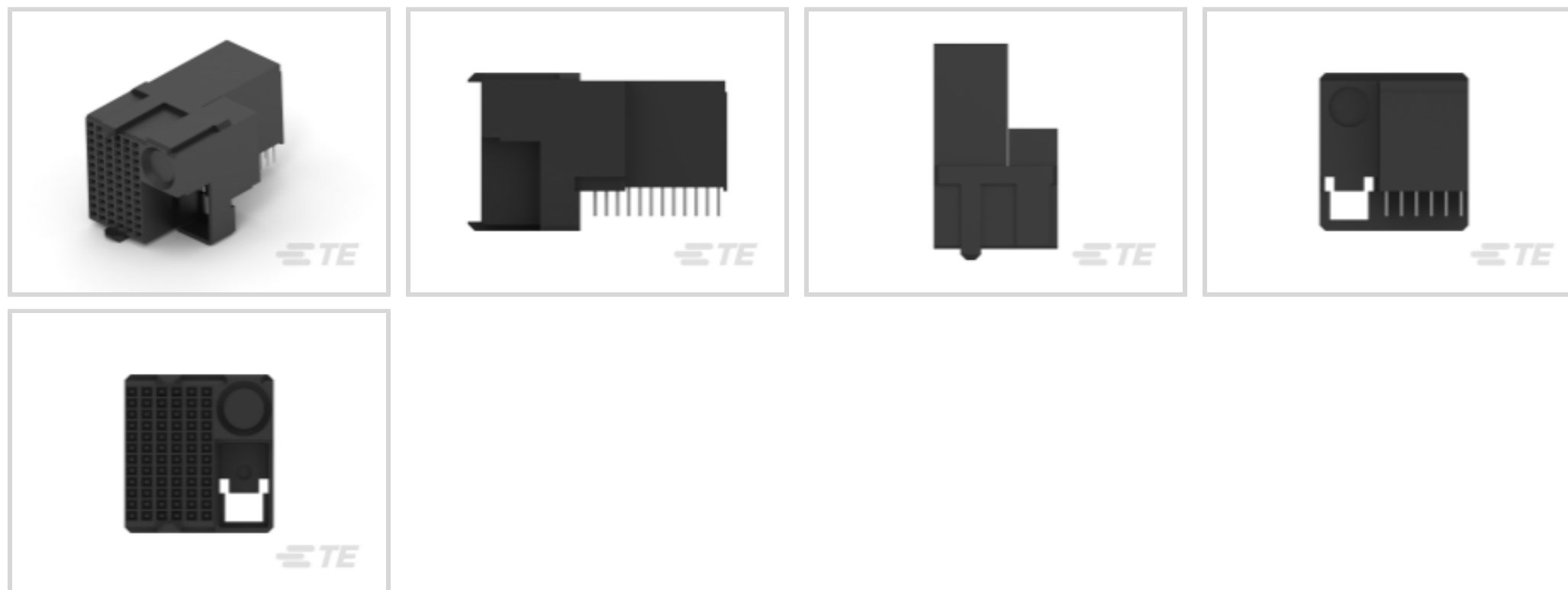

PCB Connector Assembly Type: **PCB Mount Receptacle**

Data Rate: **1 Gb/s**

Number of Columns: **6**

Number of Rows: **12**

Backplane Architecture: **Traditional Backplane**

Features

Product Type Features

Connector System	Board-to-Board
Connector & Contact Terminates To	Printed Circuit Board
PCB Connector Assembly Type	PCB Mount Receptacle
Sealable	No

Configuration Features

Number of Columns	6
Number of Rows	12
Backplane Architecture	Traditional Backplane
Number of Positions	72
PCB Mount Orientation	Right Angle

Signal Characteristics

Data Rate	1 Gb/s
-----------	--------

Body Features

Primary Product Color	Black
-----------------------	-------



Contact Features

CompactPCI Designation	None
Contact Type	Receptacle
Contact Underplating Material	Nickel
Contact Base Material	Phosphor Bronze
Contact Mating Area Plating Material	Gold
Contact Mating Area Plating Material Thickness	.7 μm [27.165 μin]
Contact Current Rating (Max)	1 A

Mechanical Attachment

Connector Mounting Type	Board Mount
-------------------------	-------------

Housing Features

Housing Material	Glass-Filled Polyester
Centerline (Pitch)	2 mm[.079 in]

Usage Conditions

Operating Temperature Range	-55 – 85 $^{\circ}\text{C}$ [-67 – 185 $^{\circ}\text{F}$]
-----------------------------	---

Operation/Application

Circuit Application	Signal
---------------------	--------

Industry Standards

UL Flammability Rating	UL 94V-0
------------------------	----------

Packaging Features

Packaging Quantity	27
Packaging Method	Tube

Product Compliance

[For compliance documentation, visit the product page on TE.com>](#)

EU RoHS Directive 2011/65/EU	Compliant
EU ELV Directive 2000/53/EC	Compliant
China RoHS 2 Directive MIIT Order No 32, 2016	No Restricted Materials Above Threshold
EU REACH Regulation (EC) No. 1907/2006	Current ECHA Candidate List: JUNE 2024 (241) Candidate List Declared Against: JAN 2024 (240) Does not contain REACH SVHC

Halogen Content	Not Low Halogen - contains Br or Cl > 900 ppm.
-----------------	--

Solder Process Capability	Not applicable for solder process capability
---------------------------	--

Product Compliance Disclaimer

This information is provided based on reasonable inquiry of our suppliers and represents our current actual knowledge based on the information they provided. This information is subject to change. The part numbers that TE has identified as EU RoHS compliant have a maximum concentration of 0.1% by weight in homogenous materials for lead, hexavalent chromium, mercury, PBB, PBDE, DBP, BBP, DEHP, DIBP, and 0.01% for cadmium, or qualify for an exemption to these limits as defined in the Annexes of Directive 2011/65/EU (RoHS2). Finished electrical and electronic equipment products will be CE marked as required by Directive 2011/65/EU. Components may not be CE marked. Additionally, the part numbers that TE has identified as EU ELV compliant have a maximum concentration of 0.1% by weight in homogenous materials for lead, hexavalent chromium, and mercury, and 0.01% for cadmium, or qualify for an exemption to these limits as defined in the Annexes of Directive 2000/53/EC (ELV). Regarding the REACH Regulation, the information TE provides on SVHC in articles for this part number is based on the latest European Chemicals Agency (ECHA) 'Guidance on requirements for substances in articles' posted at this URL: <https://echa.europa.eu/guidance-documents/guidance-on-reach>

Compatible Parts



Also in the Series | Z-PACK 2mm HM

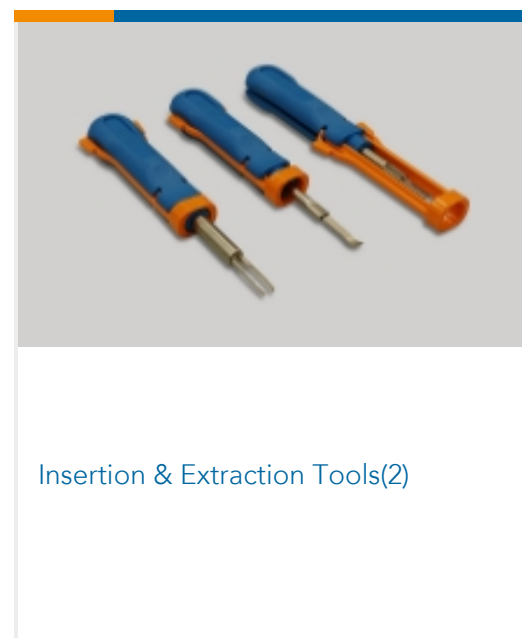
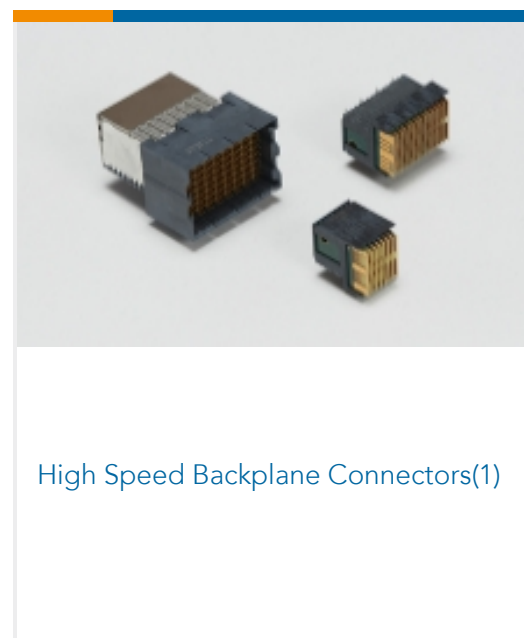
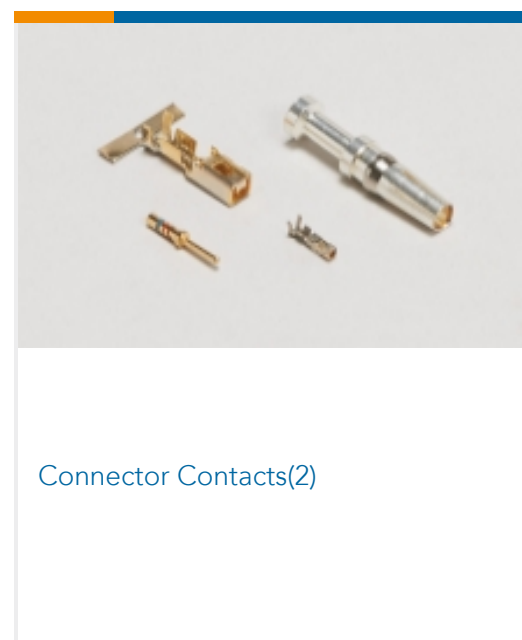
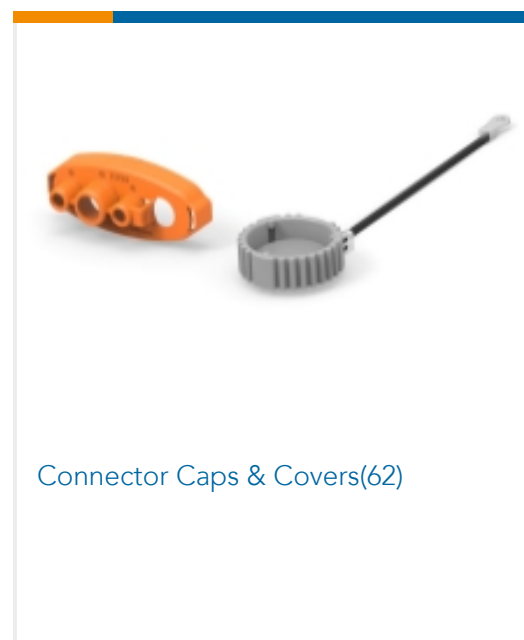
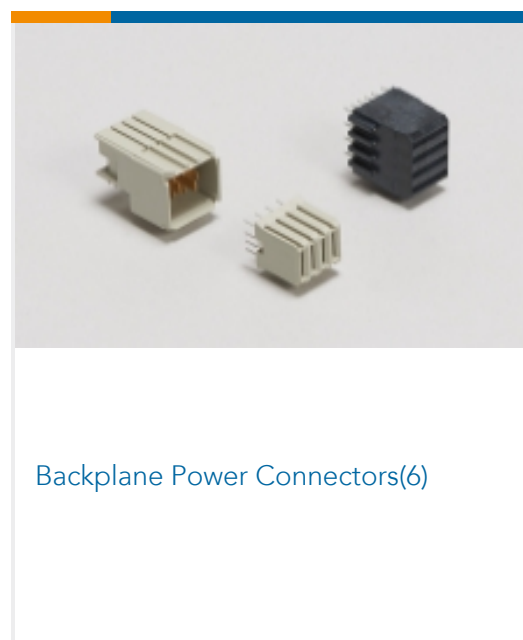
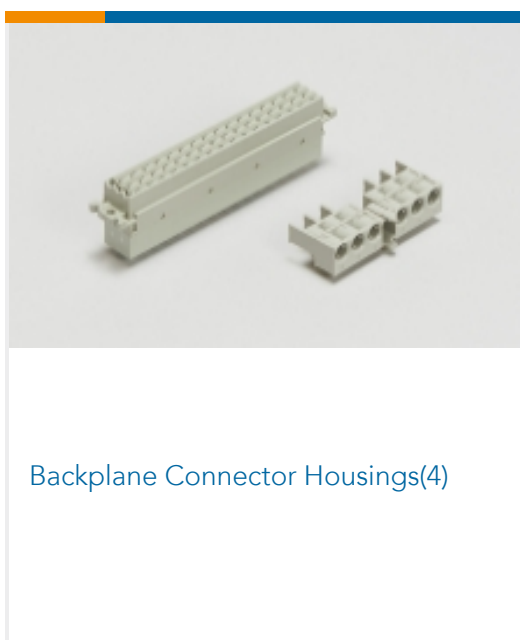



Rectangular Power Connectors(87)

Customers Also Bought

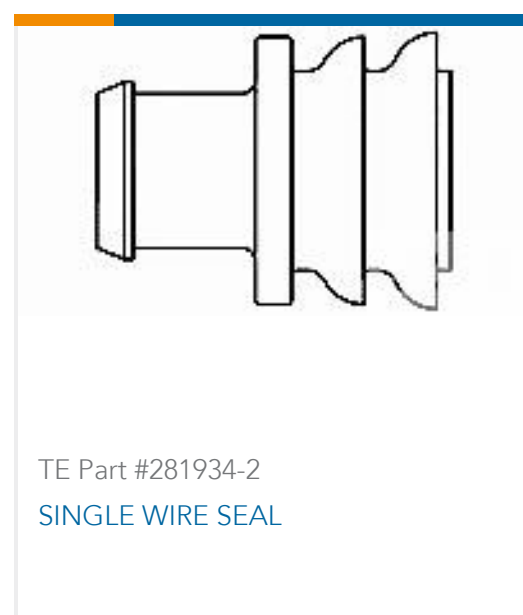
TE Part #DT04-2P
REC, 2P, GRY, NTE Part #DT06-2S
PLG, 2P, GRY, NTE Part #W2S
Wedgelocks: DEUTSCH DTTE Part #0460-202-16141
DEUTSCH Solid ContactsTE Part #282104-1
AMP SUPERSEAL 1.5MM,
CONNECTOR HOUSINGTE Part #281934-2
SINGLE WIRE SEALTE Part #114017-ZZ
SEALING PLUG, SIZE 12/16, WHT

Documents

Product Drawings

12 ROW HM RA REC ASY 072P RGHT

English

CAD Files

3D PDF

3D

Customer View Model

[ENG_CVM_CVM_1645570-1_A_c-1645570-1-a.2d_dxf.zip](#)

English

Customer View Model

[ENG_CVM_CVM_1645570-1_A_c-1645570-1-a.3d_igs.zip](#)

English

Customer View Model

[ENG_CVM_CVM_1645570-1_A_c-1645570-1-a.3d_stp.zip](#)

English

By downloading the CAD file I accept and agree to the [Terms and Conditions](#) of use.



Product Specifications

Application Specification

English

Instruction Sheets

Instruction Sheet (U.S.)

English