

## LP1N 5.08/03/90 3.2SN OR BX

**Weidmüller Interface GmbH & Co. KG**  
 Klingenbergstraße 26  
 D-32758 Detmold  
 Germany

www.weidmueller.com

### Product image



Do not use product for new developments

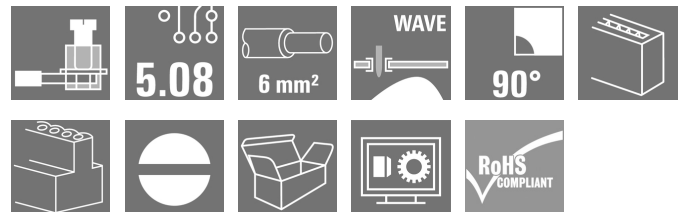

Single- and multi-row PCB terminal with proven clamping yoke connection at 5.08 mm pitch, conductor outlet direction 90°. Suitable for conductor cross-sections up to 6.0 mm<sup>2</sup>.

### General ordering data

Version	Printed circuit board terminals, 5.08 mm, Number of poles: 3, 90°, Solder pin length (l): 3.2 mm, tinned, orange, Clamping yoke connection, Clamping range, max. : 6 mm <sup>2</sup> , Box
Order No.	<a href="#">1640840000</a>
Type	LP1N 5.08/03/90 3.2SN OR BX
GTIN (EAN)	4008 190449926
Qty.	100 pc(s).
Product data	IEC: 500 V / 32 A / 0.5 - 6 mm <sup>2</sup> UL: 300 V / 20 A / AWG 26 - AWG 12
Packaging	Box

Creation date March 12, 2024 1:30:48 PM CET This article will no longer be available in the future.

Available until 2022-03-30

Alternative product [1975370000](#)

Catalogue status 09.03.2024 / We reserve the right to make technical changes.

## LP1N 5.08/03/90 3.2SN OR BX

Weidmüller Interface GmbH &amp; Co. KG

Klingenbergstraße 26

D-32758 Detmold

Germany

www.weidmueller.com

## Technical data

## Dimensions and weights

Depth	11.5 mm	Depth (inches)	0.453 inch
Height	34.2 mm	Height (inches)	1.346 inch
Height of lowest version	31 mm	Width	15.84 mm
Width (inches)	0.624 inch	Net weight	6.33 g

## System parameters

Product family	OMNIMATE Signal - series LP	Wire connection method	Clamping yoke connection
Mounting onto the PCB	THT solder connection	Conductor outlet direction	90°
Pitch in mm (P)	5.08 mm	Pitch in inches (P)	0.2 "
Number of poles	3	Pin series quantity	1
Fitted by customer	Yes	Number of rows	1
Max. adjacent poles per row	24	Solder pin length (l)	3.2 mm
Solder pin dimensions	0.75 x 0.9 mm	Solder eyelet hole diameter (D)	1.3 mm
Solder eyelet hole diameter tolerance (D)+	0.1 mm	Number of solder pins per pole	1
Screwdriver blade	0.6 x 3.5	Screwdriver blade standard	DIN 5264
Tightening torque, min.	0.5 Nm	Tightening torque, max.	0.6 Nm
Clamping screw	M 3	Stripping length	6 mm
L1 in mm	10.16 mm	L1 in inches	0.4 "
Touch-safe protection acc. to DIN VDE 0470	IP 20	Touch-safe protection acc. to DIN VDE 57 106	Safe from finger touch
Protection degree	IP20	Volume resistance	1.20 mΩ

## Material data

Insulating material	PA	Colour	orange
Colour chart (similar)	RAL 2000	Insulating material group	I
Comparative Tracking Index (CTI)	≥ 600	UL 94 flammability rating	V-2
Contact material	Cu-alloy	Contact surface	tinned
Coating	1-3 μm Ni, 4-6 μm SN	Tinning type	matt
Layer structure of solder connection	4...6 μm Ni / 4...6 μm Sn	Storage temperature, min.	-40 °C
Storage temperature, max.	70 °C	Operating temperature, min.	-50 °C
Operating temperature, max.	100 °C	Temperature range, installation, min.	-25 °C
Temperature range, installation, max.	100 °C		

## Conductors suitable for connection

Clamping range, min.	0.13 mm <sup>2</sup>	Clamping range, max.	6 mm <sup>2</sup>
Wire connection cross section AWG, min.	AWG 26	Wire connection cross section AWG, max.	AWG 12
Solid, min. H05(07) V-U	0.5 mm <sup>2</sup>	Solid, max. H05(07) V-U	6 mm <sup>2</sup>
Flexible, min. H05(07) V-K	0.5 mm <sup>2</sup>	Flexible, max. H05(07) V-K	4 mm <sup>2</sup>
w. plastic collar ferrule, DIN 46228 pt 4, min.	0.5 mm <sup>2</sup>	w. plastic collar ferrule, DIN 46228 pt 4, max.	2.5 mm <sup>2</sup>
w. wire end ferrule, DIN 46228 pt 1, min.	0.5 mm <sup>2</sup>	w. wire end ferrule, DIN 46228 pt 1, max.	2.5 mm <sup>2</sup>
Plug gauge in accordance with EN 60999 a x b; ø		Reference text	Length of ferrules is to be chosen depending on the product and the rated voltage., The outside diameter of the plastic collar should not be larger than the pitch (P)
	2.8 mm x 2.4 mm; 3.0 mm		

**LP1N 5.08/03/90 3.2SN OR BX**
**Weidmüller Interface GmbH & Co. KG**

Klingenbergstraße 26

D-32758 Detmold

Germany

www.weidmueller.com

**Technical data**
**Rated data acc. to IEC**

tested acc. to standard	IEC 60664-1, IEC 61984	Rated current, min. number of poles (Tu=20°C)	32 A
Rated current, max. number of poles (Tu=20°C)	28 A	Rated current, min. number of poles (Tu=40°C)	32 A
Rated current, max. number of poles (Tu=40°C)	24 A	Rated voltage for surge voltage class / pollution degree II/2	500 V
Rated voltage for surge voltage class / pollution degree III/2	250 V	Rated voltage for surge voltage class / pollution degree III/3	250 V
Rated impulse voltage for surge voltage class/ pollution degree II/2	4 kV	Rated impulse voltage for surge voltage class/ pollution degree III/2	4 kV
Rated impulse voltage for surge voltage class/ contamination degree III/3	4 kV	Short-time withstand current resistance	3 x 1s with 120 A

**Rated data acc. to CSA**

Institute (CSA)		Certificate No. (CSA)	200039-1202191
Rated voltage (Use group B / CSA)	300 V	Rated voltage (Use group D / CSA)	300 V
Rated current (Use group B / CSA)	20 A	Rated current (Use group D / CSA)	10 A
Wire cross-section, AWG, min.	AWG 26	Wire cross-section, AWG, max.	AWG 12
Reference to approval values	Specifications are maximum values, details - see approval certificate.		

**Rated data acc. to UL 1059**

Institute (UR)		Certificate No. (UR)	E60693
Rated voltage (Use group B / UL 1059)	300 V	Rated voltage (Use group D / UL 1059)	300 V
Rated current (Use group B / UL 1059)	20 A	Rated current (Use group D / UL 1059)	10 A
Wire cross-section, AWG, min.	AWG 26	Wire cross-section, AWG, max.	AWG 12
Reference to approval values	Specifications are maximum values, details - see approval certificate.		

**Packing**

Packaging	Box	VPE length	152 mm
VPE width	111 mm	VPE height	80 mm

**Classifications**

ETIM 6.0	EC002643	ETIM 7.0	EC002643
ETIM 8.0	EC002643	ETIM 9.0	EC002643
ECLASS 9.0	27-44-04-01	ECLASS 9.1	27-44-04-01
ECLASS 10.0	27-44-04-01	ECLASS 11.0	27-46-01-01
ECLASS 12.0	27-46-01-01	ECLASS 13.0	27-46-01-01

## LP1N 5.08/03/90 3.2SN OR BX

**Weidmüller Interface GmbH & Co. KG**  
Klingenbergstraße 26  
D-32758 Detmold  
Germany

www.weidmueller.com

## Technical data

### Important note

IPC conformity	Conformity: The products are developed, manufactured and delivered according international recognized standards and norms and comply with the assured properties in the data sheet resp. fulfill decorative properties in accordance with IPC-A-610 "Class 2". Further claims on the products can be evaluated on request.
Notes	<ul style="list-style-type: none"> <li>• Additional variants on request</li> <li>• Rated current related to rated cross-section &amp; min. No. of poles.</li> <li>• Wire end ferrule without plastic collar to DIN 46228/1</li> <li>• Wire end ferrule with plastic collar to DIN 46228/4</li> <li>• P on drawing = pitch</li> <li>• Rated data refer only to the component itself. Clearance and creepage distances to other components are to be designed in accordance with the relevant application standards.</li> <li>• Long term storage of the product with average temperature of 50 °C and maximum humidity 70%, 36 months</li> </ul>

### Approvals

Approvals



ROHS	Conform
UL File Number Search	UL Website
Certificate No. (UR)	E60693

### Downloads

Approval/Certificate/Document of Conformity	<a href="#">Declaration of the Manufacturer</a>
Product Change Notification	<a href="#">PCN_2016_273_PL32_Loss_of_nickel_LL_LP_Family_EN</a> <a href="#">PCN_2016_273_PL32_Wegfall_Unternickelung_LL_LP_Familie_DE</a>
Catalogues	<a href="#">Catalogues in PDF-format</a>
Brochures	<a href="#">FL DRIVES EN</a> <a href="#">FL ANALO.SIGN.CONV. EN</a> <a href="#">MB DEVICE MANUF. EN</a> <a href="#">FL DRIVES DE</a> <a href="#">FL BUILDING SAFETY EN</a> <a href="#">FL APPL LED LIGHTING EN</a> <a href="#">FLIndustr.CONTROLS EN</a> <a href="#">FL MACHINE SAFETY EN</a> <a href="#">FL HEATING ELECTR EN</a> <a href="#">FL APPL INVERTER EN</a> <a href="#">FL_BASE_STATION_EN</a> <a href="#">FL ELEVATOR EN</a> <a href="#">FL POWER SUPPLY EN</a> <a href="#">FL 72H SAMPLE SER EN</a> <a href="#">PO OMNIMATE EN</a> <a href="#">PO OMNIMATE EN</a>

Creation date March 12, 2024 1:36:48 PM CET

Catalogue status 09.03.2024 / We reserve the right to make technical changes.

**LP1N 5.08/03/90 3.2SN OR BX**

**Weidmüller Interface GmbH & Co. KG**  
 Klingenbergstraße 26  
 D-32758 Detmold  
 Germany

www.weidmueller.com

**Drawings**

**Dimensional drawing**

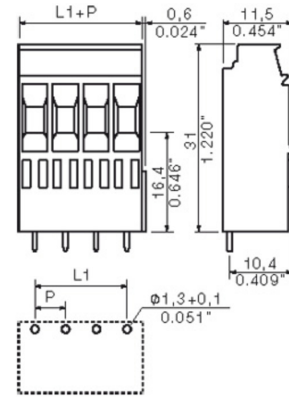

**Graph**

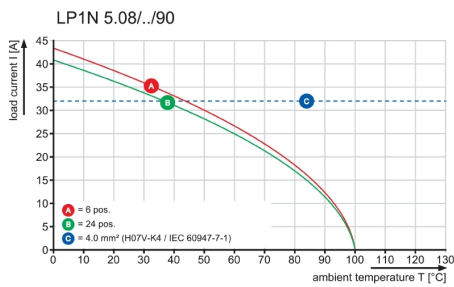

## LP1N 5.08/03/90 3.2SN OR BX

**Weidmüller Interface GmbH & Co. KG**  
Klingenbergstraße 26  
D-32758 Detmold  
Germany

www.weidmueller.com

## Accessories

### Intermediate plates



#### The maximum voltage is based on the minimum distance.

Intermediate plates increase the creepage and clearance distances between different potentials and permit higher rated voltages or a clear separation, e.g. between mains and low voltages or different protection zones. The dovetail joint enables easy installation and guarantees a secure fit. Other characteristics include:

- Pitch extended by 1.27 or 2.54mm - all other combinations possible
- Colour coding ensures visual differentiation
- Different geometries for standard designs.

Incomplete individual assemblies avoided because separate terminal blocks combine to form a single holistic unit. Ready-assembled on request.

The advantages: efficient processing, increased stability, improved reliability.

### General ordering data

Type	LPZP1N 2.54 OR	Version	Product data	Packaging
Order No.	<a href="#">1747470000</a>	Printed circuit board terminals, Accessories, Intermediate plate, orange, Number of poles: 1		Box
GTIN (EAN)	4008190992156			
Qty.	100 pc(s).			
Type	LPZP1N 2.54 SW	Version	Product data	Packaging
Order No.	<a href="#">1747520000</a>	Printed circuit board terminals, Accessories, Intermediate plate, black, Number of poles: 1		Box
GTIN (EAN)	4008190992200			
Qty.	100 pc(s).			

### Function indicators



#### Everything under control:

The function indicator is easy to retrofit and clearly indicates the switching state at the clamping point - also available with large format marking holder. One of the most versatile and efficient terminal printing systems with 5mm pitch: the Weidmüller LP series.

- Holder for 3mm standard LEDs
- Simple installation on the back of SP series terminals.
- Optional marking holder for advanced marking options (WS10/5 and WS12/5, see markings)

The easiest, most reliable way of monitoring switching states.

In brief: minimum effort, maximum reliability.

### General ordering data

Type	LPA FA2	Version	Product data	Packaging
Order No.	<a href="#">1495960000</a>	Printed circuit board terminals, Accessories, Function indicator, black, Number of poles: 2		Box
GTIN (EAN)	4008190173500			
Qty.	50 pc(s).			

## LP1N 5.08/03/90 3.2SN OR BX

**Weidmüller Interface GmbH & Co. KG**  
Klingenbergstraße 26  
D-32758 Detmold  
Germany

www.weidmueller.com

## Accessories

Type	LPA FA2 BZ	Version	Product data	Packaging
Order No.	<a href="#">1496160000</a>	Printed circuit board terminals, Accessories, Function indicator, black,		Box
GTIN (EAN)	4008190100988	Number of poles: 2		
Qty.	50 pc(s).			
Type	LPA FA3 BZ	Version	Product data	Packaging
Order No.	<a href="#">1496260000</a>	Printed circuit board terminals, Accessories, Function indicator, black,		Box
GTIN (EAN)	4008190101862	Number of poles: 3		
Qty.	50 pc(s).			
Type	LPA FA3	Version	Product data	Packaging
Order No.	<a href="#">1496060000</a>	Printed circuit board terminals, Accessories, Function indicator, black,		Box
GTIN (EAN)	4008190062330	Number of poles: 3		
Qty.	50 pc(s).			

## Marker holder



### Finds space on the smallest terminal:

The marking holder is easy to retrofit and provides a large additional labelling space - the Weidmüller LP series is one of the most versatile and efficient terminal printing systems with 5mm pitch.

3 steps to clear, legible labels:

The most professional, convenient method of marking clamping points direct on the module - no confusion between clamping points and no incorrect wiring connections.

Minimum effort, maximum effect.

## General ordering data

Type	LPA BZ2	Version	Product data	Packaging
Order No.	<a href="#">1497260000</a>	Printed circuit board terminals, Accessories, Marker holder, black,		Box
GTIN (EAN)	4008190027902	Number of poles: 2		
Qty.	100 pc(s).			
Type	LPA BZ3	Version	Product data	Packaging
Order No.	<a href="#">1497360000</a>	Printed circuit board terminals, Accessories, Marker holder, black,		Box
GTIN (EAN)	4008190127022	Number of poles: 3		
Qty.	100 pc(s).			

## LP1N 5.08/03/90 3.2SN OR BX

**Weidmüller Interface GmbH & Co. KG**  
 Klingenbergstraße 26  
 D-32758 Detmold  
 Germany

www.weidmueller.com

## Accessories

### Mounting blocks



#### Minor component, major effect:

Clip-on attachment elements increase the mechanical resilience of the circuit board terminals.

Clip-on or pre-assembled - always the right solution:

- Hard-wearing, precise fitting dovetail joint
- Hard-wearing metal threaded inserts
- Suitable for all outlet directions

Maximum stability, minimum effort:

- Extremely resilient for frequent fastening operations
- Complete set for easy selection

The result: soldering points, contacts and overall module are more resilient against mechanical stress such as vibrations and tensile loads.

### General ordering data

Type	Version	Product data	Packaging
LPBB MU OR			
Order No. <a href="#">1747530000</a>	Printed circuit board terminals, Accessories, Mounting block, orange,		Box
GTIN (EAN) 4008190992217	Number of poles: 1		
Qty. 100 pc(s).			
LPBB OR			
Order No. <a href="#">1747540000</a>	Printed circuit board terminals, Accessories, Mounting block, orange,		Box
GTIN (EAN) 4008190992224	Number of poles: 1		
Qty. 100 pc(s).			
LPBB MU SW			
Order No. <a href="#">1747550000</a>	Printed circuit board terminals, Accessories, Mounting block, black,		Box
GTIN (EAN) 4008190992231	Number of poles: 1		
Qty. 100 pc(s).			
LPBB SW			
Order No. <a href="#">1747560000</a>	Printed circuit board terminals, Accessories, Mounting block, black,		Box
GTIN (EAN) 4008190992248	Number of poles: 1		
Qty. 100 pc(s).			

## LP1N 5.08/03/90 3.2SN OR BX

**Weidmüller Interface GmbH & Co. KG**  
 Klingenbergstraße 26  
 D-32758 Detmold  
 Germany

www.weidmueller.com

## Accessories

### Cross-connections



#### Large potential for small terminals.

For efficient electrical distribution directly at the connection:

- Isolated comb rail
- Available with the most standard pole numbers
- Easy to shorten

Simply reduce in size to match the number of poles and connect with the conductor in a single working procedure.

For retrofitting or deliberate reduction of the thermal load on the PCB.

### General ordering data

Type	LPA QB 2	Version	Product data	Packaging
Order No.	<a href="#">1472200000</a>	Printed circuit board terminals, Accessories, Cross-connector, Number		Box
GTIN (EAN)	4008190096298	of poles: 2		
Qty.	50 pc(s).			
Type	LPA QB 3	Version	Product data	Packaging
Order No.	<a href="#">1472300000</a>	Printed circuit board terminals, Accessories, Cross-connector, Number		Box
GTIN (EAN)	4008190093914	of poles: 3		
Qty.	50 pc(s).			

DIE DEUTSCHE VERSION IST VERBINDLICH  
THE GERMAN VERSION IS BINDING

WEITERGABE SOWIE VERVIELFÄLTIGUNG DIESES DOKUMENTS, VERWERTUNG UND MITTEILUNG SEINES INHALTS SIND VERBOTEN, SOWEIT NICHT AUSDRUECKLICH GESTATTET.  
 ZUWIDERHANDLUNGEN VERPFLICHTEN ZU SCHADENERSATZ. ALLE RECHTE FUER DEN FALL DER PATENT-, GEBRAUCHSMUSTER- ODER GESCHMACKSMUSTEREINTRAGUNG VORBEHALTEN.  
 THE REPRODUCTION, DISTRIBUTION AND UTILIZATION OF THIS DOCUMENT AS WELL AS THE COMMUNICATION OF ITS CONTENTS TO OTHERS WITHOUT EXPLICIT AUTHORIZATION IS PROHIBITED.  
 OFFENDERS WILL BE HELD LIABLE FOR THE PAYMENT OF DAMAGES. WEIDMUELLER EXCLUSIVELY RESERVES THE RIGHT TO FILE FOR PATENTS, UTILITY MODELS OR DESIGNS.  
 © WEIDMUELLER INTERFACE GmbH & Co.KG

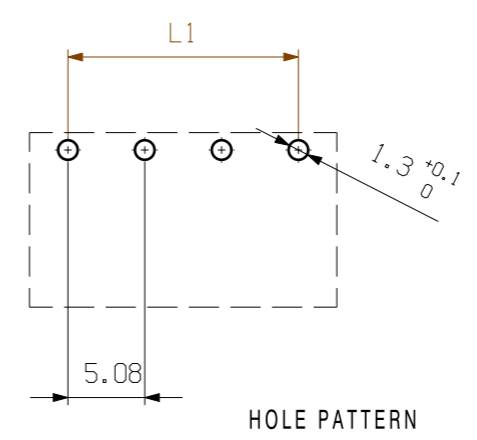
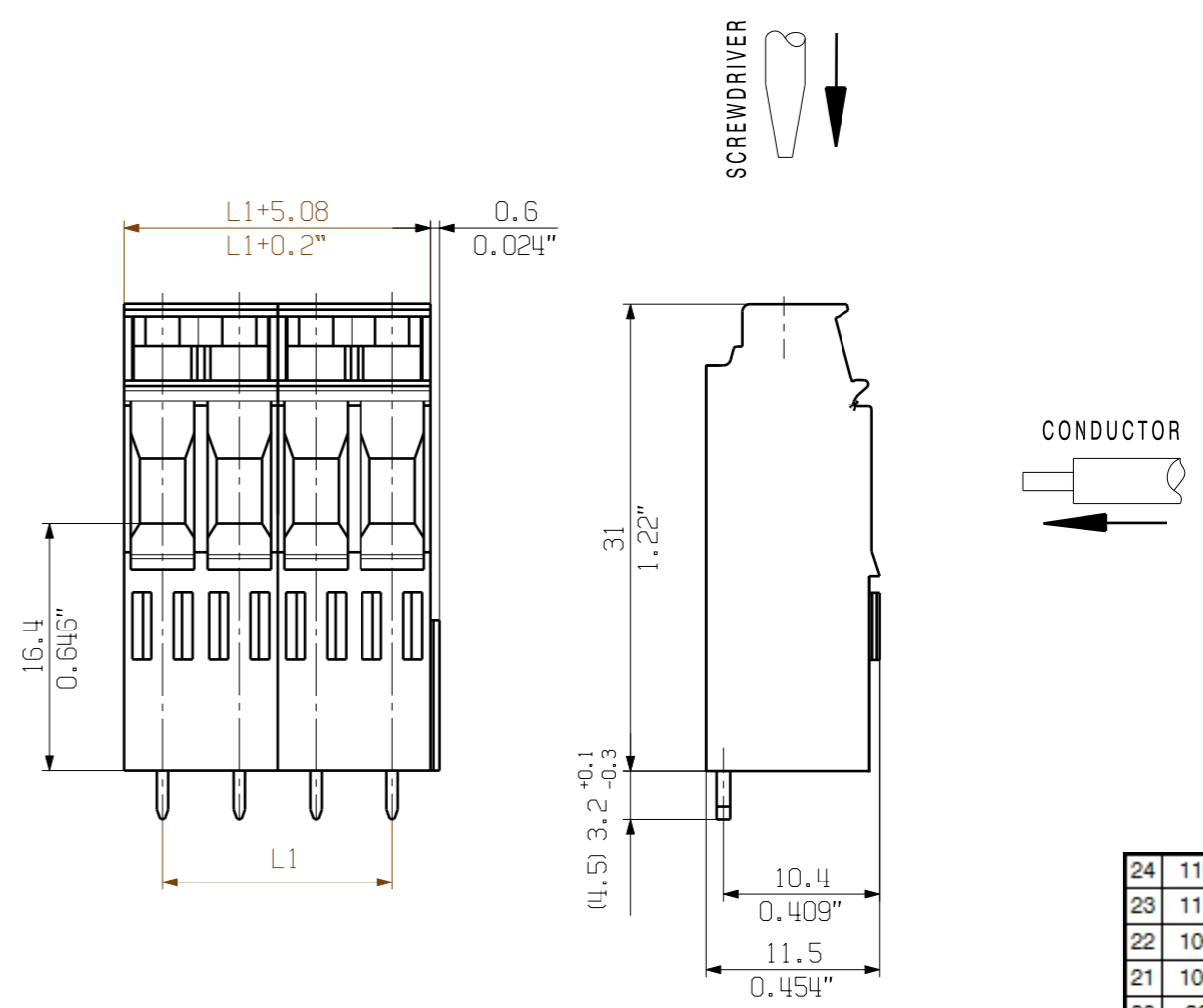

24	116,84	4,600
23	111,76	4,400
22	106,68	4,200
21	101,60	4,000
20	96,52	3,800
19	91,44	3,600
18	86,36	3,400
17	81,28	3,200
16	76,20	3,000
15	71,12	2,800
14	66,04	2,600
13	60,96	2,400
12	55,88	2,200
11	50,80	2,000
10	45,72	1,800
9	40,64	1,600
8	35,56	1,400
7	30,48	1,200
6	25,40	1,000
5	20,32	0,800
4	15,24	0,600
3	10,16	0,400
2	5,08	0,200
n	L1 [mm]	L1 [Inch]

SHOWN: LP1N 5.08/04/90...

For the mounting of PCBs, it should be noted that the rated data stated here relates only to the PCB components alone.  
 The necessary creepage and clearance paths must be observed in connection with the respective applicant in accordance to IEC 664 / VDE 0110.  
 The current-carrying capacity and pitch tolerance is to be determined according to DIN IEC 326 part 3 very fine.

Weidmüller PCB components are tested to the DIN EN 61984 standard, and are valid for its field of application.  
 Provided that the components are used to the intended purpose, all requirements with respect to the occurring of electrical, mechanical, thermic and corrosive stress will be satisfied.

	<b>METRIC TOLERANCES</b> X. = ±0.3 X.X = ±0.1 X.XX = ±0.05		CAT.NO.: <b>C 21227 13</b>	
	59484/0 22.07.11 KRUG_M 01		DRAWING NO. OF 01 SHEETS <b>13</b>	
		<b>MODIFICATION</b>		
SCALE: 2/1 SUPERSEDES:		DATE 11.05.2009	NAME HELIS_MA	
		RESPONSIBLE KRUG_M	CHECKED 25.07.2011 HECKERT_M	
		APPROVED HECKERT_M	<b>LP1N 5.08/./90...</b> LEITERPLATTENKLEMME PCB-TERMINAL	
		PRODUCT FILE: LP2N(2H 3R)		7361

## Recommended wave soldering profiles

**Weidmüller Interface GmbH & Co. KG**  
 Klängenbergstraße 16  
 D-32758 Detmold  
 Germany  
 Fon: +49 5231 14-0  
 Fax: +49 5231 14-292083  
 www.weidmueller.com

### Single Wave:

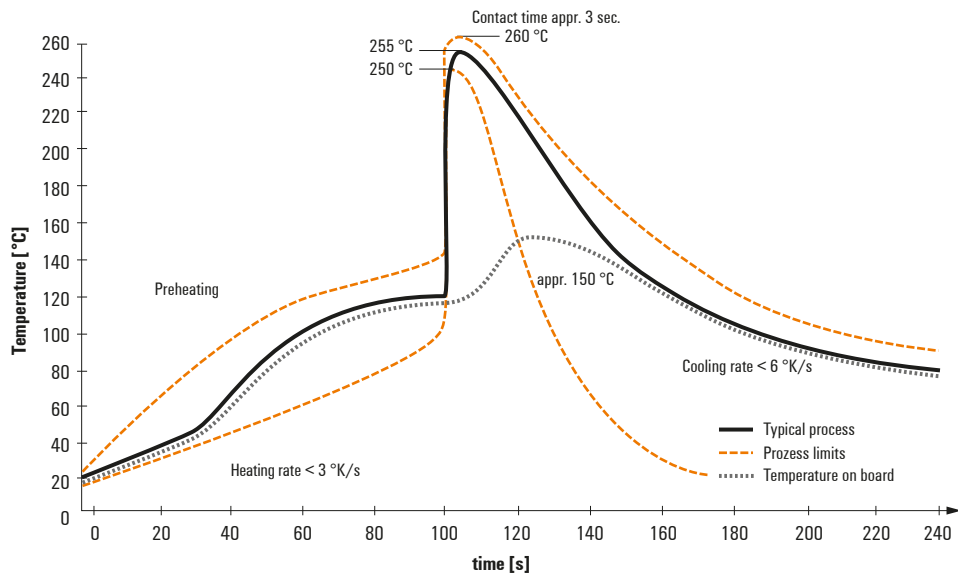

### Double Wave:

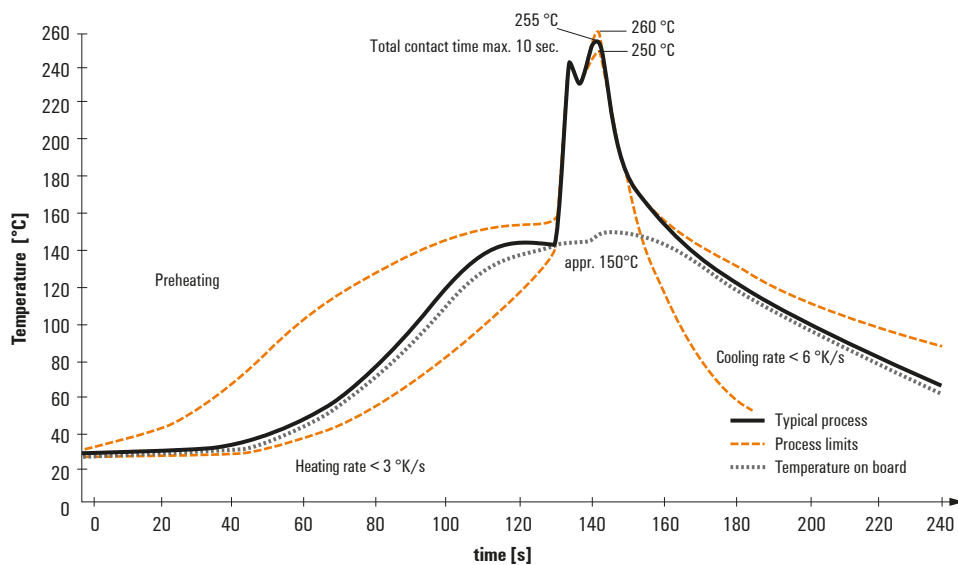

### Wave soldering profiles

Wired connection elements should be processed in accordance with the DIN EN 61760-1 standard. We have included two recommendations for practical wave soldering profiles, with which Weidmüller PCB terminals and connectors are qualified.

When choosing a suitable profile for your application, the following factors also need to be considered:

- PCB thickness
- Proportion of Cu in the layers
- Single/double-sided assembly
- Product range
- Heating and cooling rates

The single and double wave profiles each indicate the recommended operating range, including the maximum soldering temperature of 260°C. In practice, the maximum soldering temperature is quite often well below the above maximum profile.