

LU 10.16/03/90 4STI 4.5SN GY BX

Weidmüller Interface GmbH & Co. KG
 Klingenbergstraße 26
 D-32758 Detmold
 Germany

www.weidmueller.com

Product image

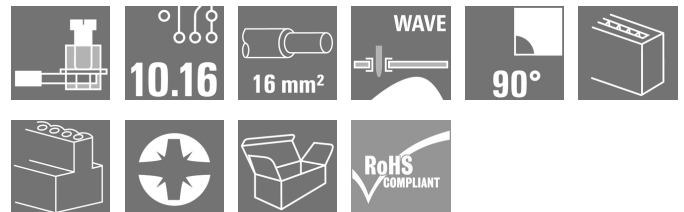
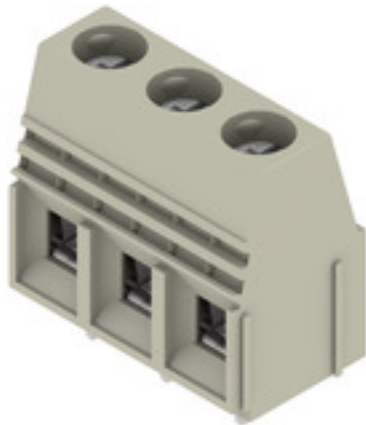

This PCB terminal provides connections for 76 A and 16 mm² conductor cross-section with proven clamping yoke connection at 10.16 mm pitch, conductor outlet direction in 90° design.

General ordering data

Version	Printed circuit board terminals, 10.16 mm, Number of poles: 3, 90°, Solder pin length (l): 4.5 mm, tinned, Pebble grey, Clamping yoke connection, Clamping range, max. : 16 mm ² , Box
Order No.	1636180000
Type	LU 10.16/03/90 4STI 4.5SN GY BX
GTIN (EAN)	4008190267100
Qty.	20 pc(s).
Product data	IEC: 1000 V / 76 A / 0.5 - 16 mm ² UL: 300 V / 65 A / AWG 26 - AWG 6
Packaging	Box

Creation date March 12, 2024 11:22:34 AM CET

LU 10.16/03/90 4STI 4.5SN GY BX

Weidmüller Interface GmbH & Co. KG
Klingenbergstraße 26
D-32758 Detmold
Germany

www.weidmueller.com

Technical data

Dimensions and weights

Depth	18.3 mm	Depth (inches)	0.72 inch
Height	33 mm	Height (inches)	1.299 inch
Height of lowest version	28.5 mm	Width	30.48 mm
Width (inches)	1.2 inch	Net weight	30.6 g

System parameters

Product family	OMNIMATE Power - series LU	Wire connection method	Clamping yoke connection
Mounting onto the PCB	THT solder connection	Conductor outlet direction	90°
Pitch in mm (P)	10.16 mm	Pitch in inches (P)	0.4 "
Number of poles	3	Pin series quantity	1
Fitted by customer	Yes	Number of rows	1
Max. adjacent poles per row	10	Solder pin length (l)	4.5 mm
Solder pin dimensions	1.2 x 1.2 mm	Solder pin dimensions = d tolerance	0 / -0,15 mm
Solder eyelet hole diameter (D)	1.6 mm	Solder eyelet hole diameter tolerance (D)+	0,1 mm
Number of solder pins per pole	4	Screwdriver blade	1.0 x 5.5
Screwdriver blade standard	DIN 5264	Tightening torque, min.	1.2 Nm
Tightening torque, max.	2.2 Nm	Clamping screw	M 4
Stripping length	12 mm	L1 in mm	20.32 mm
L1 in inches	0.8 "	Touch-safe protection acc. to DIN VDE 0470	IP20 plugged/ IP10 unplugged
Touch-safe protection acc. to DIN VDE 57 106	Safe from finger touch	Protection degree	IP20
Volume resistance	0.50 mΩ		

Material data

Insulating material	Wemid (PA)	Colour	Pebble grey
Colour chart (similar)	RAL 7032	Insulating material group	I
Comparative Tracking Index (CTI)	≥ 600	UL 94 flammability rating	V-0
Contact material	Cu-alloy	Contact surface	tinned
Layer structure of solder connection	1.5...3 µm Ni / 4...6 µm Sn matt	Storage temperature, min.	-40 °C
Storage temperature, max.	70 °C	Operating temperature, min.	-50 °C
Operating temperature, max.	120 °C	Temperature range, installation, min.	-25 °C
Temperature range, installation, max.	120 °C		

Conductors suitable for connection

Clamping range, min.	0.14 mm ²
Clamping range, max.	16 mm ²
Wire connection cross section AWG, min.	AWG 22
Wire connection cross section AWG, max.	AWG 8
Solid, min. H05(07) V-U	0.5 mm ²
Solid, max. H05(07) V-U	16 mm ²
Stranded, min. H07V-R	6 mm ²
Stranded, max. H07V-R	16 mm ²
Flexible, min. H05(07) V-K	0.5 mm ²
Flexible, max. H05(07) V-K	16 mm ²
w. plastic collar ferrule, DIN 46228 pt 4, 2.5 mm ² min.	
w. plastic collar ferrule, DIN 46228 pt 4, 10 mm ² max.	

Creation date March 12, 2024 11:22:34 AM CET

LU 10.16/03/90 4STI 4.5SN GY BX

Weidmüller Interface GmbH & Co. KG
 Klingenbergstraße 26
 D-32758 Detmold
 Germany

www.weidmueller.com

Technical data

w. wire end ferrule, DIN 46228 pt 1, min.	2.5 mm ²			
w. wire end ferrule, DIN 46228 pt 1, max.	10 mm ²			
Plug gauge in accordance with EN 60999 a x b; ø	5.4 mm x 5.1 mm; 5.3 mm			
Clampable conductor	Cross-section for conductor connection	Type	fine-wired	
		nominal	2.5 mm ²	
	wire end ferrule	Stripping length	nominal	12 mm
		Recommended wire-end ferrule	H2.5/12	
		Stripping length	nominal	14 mm
		Recommended wire-end ferrule	H2.5/19D BL	
	Cross-section for conductor connection	Type	fine-wired	
		nominal	4 mm ²	
	wire end ferrule	Stripping length	nominal	12 mm
		Recommended wire-end ferrule	H4.0/12	
		Stripping length	nominal	14 mm
		Recommended wire-end ferrule	H4.0/20D GR	
	Cross-section for conductor connection	Type	fine-wired	
		nominal	6 mm ²	
	wire end ferrule	Stripping length	nominal	12 mm
		Recommended wire-end ferrule	H6.0/12	
		Stripping length	nominal	14 mm
		Recommended wire-end ferrule	H6.0/20 SW	
	Cross-section for conductor connection	Type	fine-wired	
		nominal	10 mm ²	
wire end ferrule	Stripping length	nominal	15 mm	
	Recommended wire-end ferrule	H10.0/22 EB		
	Stripping length	nominal	12 mm	
	Recommended wire-end ferrule	H10.0/12		

Reference text Length of ferrules is to be chosen depending on the product and the rated voltage.. The outside diameter of the plastic collar should not be larger than the pitch (P)

Rated data acc. to IEC

tested acc. to standard	IEC 60664-1, IEC 61984	Rated current, min. number of poles (Tu=20°C)	76 A
Rated current, max. number of poles (Tu=20°C)	72 A	Rated current, min. number of poles (Tu=40°C)	76 A
Rated current, max. number of poles (Tu=40°C)	62 A	Rated voltage for surge voltage class / pollution degree II/2	1,000 V
Rated voltage for surge voltage class / pollution degree III/2	690 V	Rated voltage for surge voltage class / pollution degree III/3	690 V
Rated impulse voltage for surge voltage class/ pollution degree II/2	4 kV	Rated impulse voltage for surge voltage class/ pollution degree III/2	6 kV
Rated impulse voltage for surge voltage class/ contamination degree III/3	6 kV	Short-time withstand current resistance	2 x 1s with 700 A

LU 10.16/03/90 4STI 4.5SN GY BX

Weidmüller Interface GmbH & Co. KG
 Klingenbergstraße 26
 D-32758 Detmold
 Germany

www.weidmueller.com

Technical data

Rated data acc. to CSA

Institute (CSA)				Certificate No. (CSA)	
				200039-1198743	
Rated voltage (Use group B / CSA)	300 V	Rated voltage (Use group C / CSA)	150 V		
Rated voltage (Use group D / CSA)	300 V	Rated current (Use group B / CSA)	65 A		
Rated current (Use group C / CSA)	65 A	Rated current (Use group D / CSA)	10 A		
Wire cross-section, AWG, min.	AWG 22	Wire cross-section, AWG, max.	AWG 6		
Reference to approval values	Specifications are maximum values, details - see approval certificate.				

Rated data acc. to UL 1059

Institute (UR)				Certificate No. (UR)	
				E60693	
Rated voltage (Use group B / UL 1059)	300 V	Rated voltage (Use group C / UL 1059)	150 V		
Rated voltage (Use group D / UL 1059)	600 V	Rated current (Use group B / UL 1059)	65 A		
Rated current (Use group C / UL 1059)	65 A	Rated current (Use group D / UL 1059)	5 A		
Wire cross-section, AWG, min.	AWG 26	Wire cross-section, AWG, max.	AWG 6		
Reference to approval values	Specifications are maximum values, details - see approval certificate.				

Packing

Packaging	Box	VPE length	141 mm
VPE width	105 mm	VPE height	40 mm

Type tests

Test: Durability of markings	Test	mark of origin, type identification, type of material, rated cross-section, approval marking CSA, approval marking UL, pitch, durability
	Evaluation	available

LU 10.16/03/90 4STI 4.5SN GY BX

Weidmüller Interface GmbH & Co. KG
 Klingenbergstraße 26
 D-32758 Detmold
 Germany

www.weidmueller.com

Technical data

Test: Clampable cross section	Conductor type	Type of conductor and conductor cross-section	H05V-K0.5
		Type of conductor and conductor cross-section	H05V-U0.5
		Type of conductor and conductor cross-section	H07V-K10
		Type of conductor and conductor cross-section	H07V-U10
		Type of conductor and conductor cross-section	H07V-U16
		Type of conductor and conductor cross-section	AWG 8/19
		Type of conductor and conductor cross-section	AWG 22/1
		Type of conductor and conductor cross-section	AWG 22/19
		Evaluation	passed
Test for damage to and accidental loosening of conductors	Standard	EN 60947-1/1991 section 8.2.4.3	
	Requirement	0.3 kg	
	Conductor type	Type of conductor and conductor cross-section	H05V-K0.5
		Type of conductor and conductor cross-section	H05V-U0.5
		Type of conductor and conductor cross-section	AWG 22/1
		Type of conductor and conductor cross-section	AWG 22/19
	Evaluation	passed	
	Requirement	2.0 kg	
	Conductor type	Type of conductor and conductor cross-section	H07V-K10
		Type of conductor and conductor cross-section	H07V-U10
		Type of conductor and conductor cross-section	AWG 8/19
	Evaluation	passed	
	Requirement	2.9 kg	
Conductor type	Type of conductor and conductor cross-section	H07V-U16	
Evaluation	passed		

LU 10.16/03/90 4STI 4.5SN GY BX

Weidmüller Interface GmbH & Co. KG
 Klingenbergstraße 26
 D-32758 Detmold
 Germany

www.weidmueller.com

Technical data

Pull-out test	Standard	EN 60947-1/1991 section 8.2.4.4		
	Requirement	≥20 N		
	Conductor type	Type of conductor and conductor cross-section	AWG 22/1	
		Type of conductor and conductor cross-section	AWG 22/19	
	Evaluation	passed		
	Requirement	≥30 N		
	Conductor type	Type of conductor and conductor cross-section	H05V-K0.5	
		Type of conductor and conductor cross-section	H05V-U0.5	
	Evaluation	passed		
	Requirement	≥ 90N		
	Conductor type	Type of conductor and conductor cross-section	H07V-K10	
		Type of conductor and conductor cross-section	H07V-U10	
		Type of conductor and conductor cross-section	AWG 8/19	
	Evaluation	passed		
	Requirement	≥100 N		
Conductor type	Type of conductor and conductor cross-section	H07V-U16		
Evaluation	passed			

Classifications

ETIM 6.0	EC002643	ETIM 7.0	EC002643
ETIM 8.0	EC002643	ETIM 9.0	EC002643
ECLASS 9.0	27-44-04-01	ECLASS 9.1	27-44-04-01
ECLASS 10.0	27-44-04-01	ECLASS 11.0	27-46-01-01
ECLASS 12.0	27-46-01-01	ECLASS 13.0	27-46-01-01

LU 10.16/03/90 4STI 4.5SN GY BX

Weidmüller Interface GmbH & Co. KG
 Klingenbergstraße 26
 D-32758 Detmold
 Germany

www.weidmueller.com

Technical data

Important note

IPC conformity	Conformity: The products are developed, manufactured and delivered according international recognized standards and norms and comply with the assured properties in the data sheet resp. fulfill decorative properties in accordance with IPC-A-610 "Class 2". Further claims on the products can be evaluated on request.
Notes	<ul style="list-style-type: none"> • Additional variants on request • Rated current related to rated cross-section & min. No. of poles. • Wire end ferrule without plastic collar to DIN 46228/1 • Wire end ferrule with plastic collar to DIN 46228/4 • P on drawing = pitch • Rated data refer only to the component itself. Clearance and creepage distances to other components are to be designed in accordance with the relevant application standards. • Long term storage of the product with average temperature of 50 °C and maximum humidity 70%, 36 months

Approvals

Approvals



ROHS	Conform
UL File Number Search	UL Website
Certificate No. (UR)	E60693

Downloads

Engineering Data	CAD data – STEP
Product Change Notification	20220201 Visual change OMNIMATE® Power PCB terminal blocks and connectors 20220201 Visuelle Änderung OMNIMATE® Power Leiterplattenklemmen und -steckverbinder
Catalogues	Catalogues in PDF-format
Brochures	FL DRIVES EN FL DRIVES DE

Data sheet

LU 10.16/03/90 4STI 4.5SN GY BX

Weidmüller Interface GmbH & Co. KG
 Klingenbergstraße 26
 D-32758 Detmold
 Germany

www.weidmueller.com

Drawings

Dimensional drawing

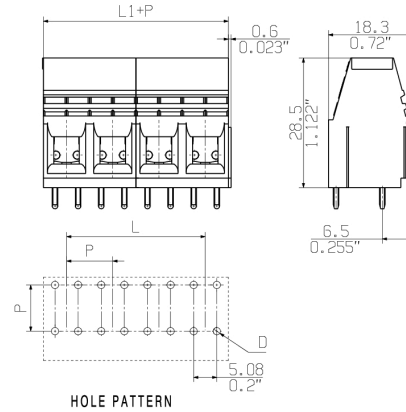

Graph

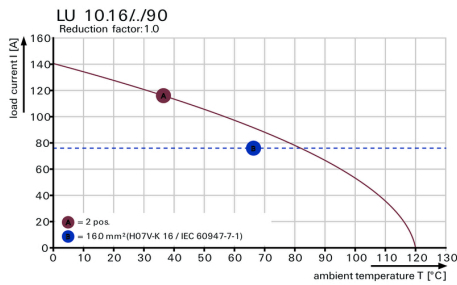

LU 10.16/03/90 4STI 4.5SN GY BX

Weidmüller Interface GmbH & Co. KG
 Klingenbergstraße 26
 D-32758 Detmold
 Germany

www.weidmueller.com

Accessories

Digits continuous

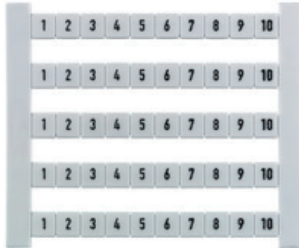

The dekafix (DEK) marker is the universal marker for all conductor and plug-in connectors as well as for electronic sub-assemblies. The system is ideal for short number sequences and covers a large range of ready-printed markers. Strips for fast installation in one work step. The printing is easy to read, rich in contrast, and is available in five widths.

- Large range of ready-to-use markers
- Strips for fast installation
- Terminal markers, suitable for all Weidmüller cable connectors
- Available as blank cards, MultiCard or as cards with standard printing

General ordering data

Type	DEK 5 FW 2,4,...100	Version	
Order No.	1358560000	Dekafix, Terminal marker, 5 x 5 mm, Pitch in mm (P): 5.00	
GTIN (EAN)	4008190075156	Weidmueller, white	
Qty.	500 pc(s).		

Recommended wave soldering profiles

Weidmüller Interface GmbH & Co. KG
 Klängenbergstraße 16
 D-32758 Detmold
 Germany
 Fon: +49 5231 14-0
 Fax: +49 5231 14-292083
 www.weidmueller.com

Single Wave:



Double Wave:

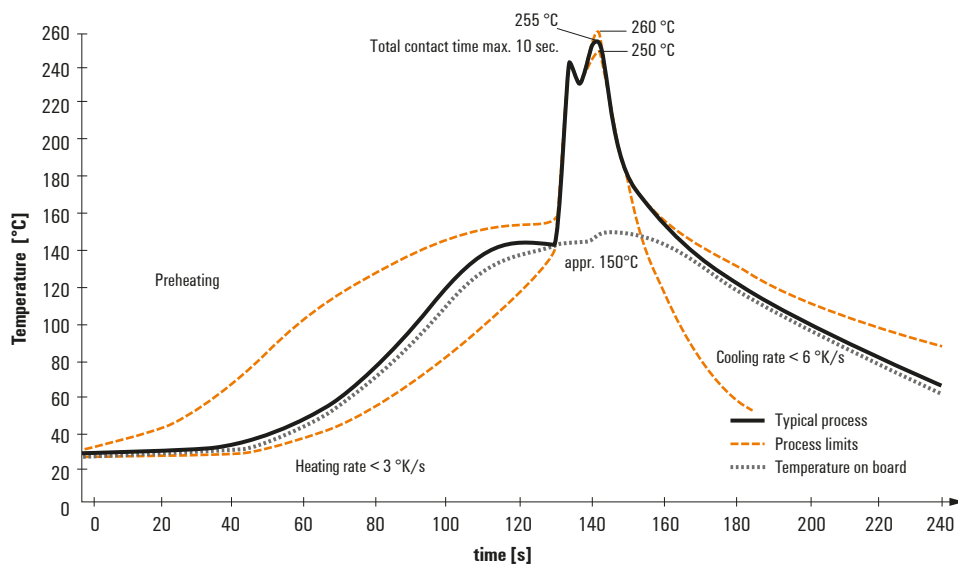

Wave soldering profiles

Wired connection elements should be processed in accordance with the DIN EN 61760-1 standard. We have included two recommendations for practical wave soldering profiles, with which Weidmüller PCB terminals and connectors are qualified.

When choosing a suitable profile for your application, the following factors also need to be considered:

- PCB thickness
- Proportion of Cu in the layers
- Single/double-sided assembly
- Product range
- Heating and cooling rates

The single and double wave profiles each indicate the recommended operating range, including the maximum soldering temperature of 260°C. In practice, the maximum soldering temperature is quite often well below the above maximum profile.