



FASTIN-FASTON | FASTIN-FASTON 110

TE Internal #: 160655-4

Quick Disconnects, Receptacle, 20 – 15 AWG Wire Size, .51 – 1.65 mm² Wire Size, Mating Tab Width 2.8 mm [.11 in], Straight, FASTIN-FASTON 110

[View on TE.com >](#)

Terminals & Splices > Quick Disconnects

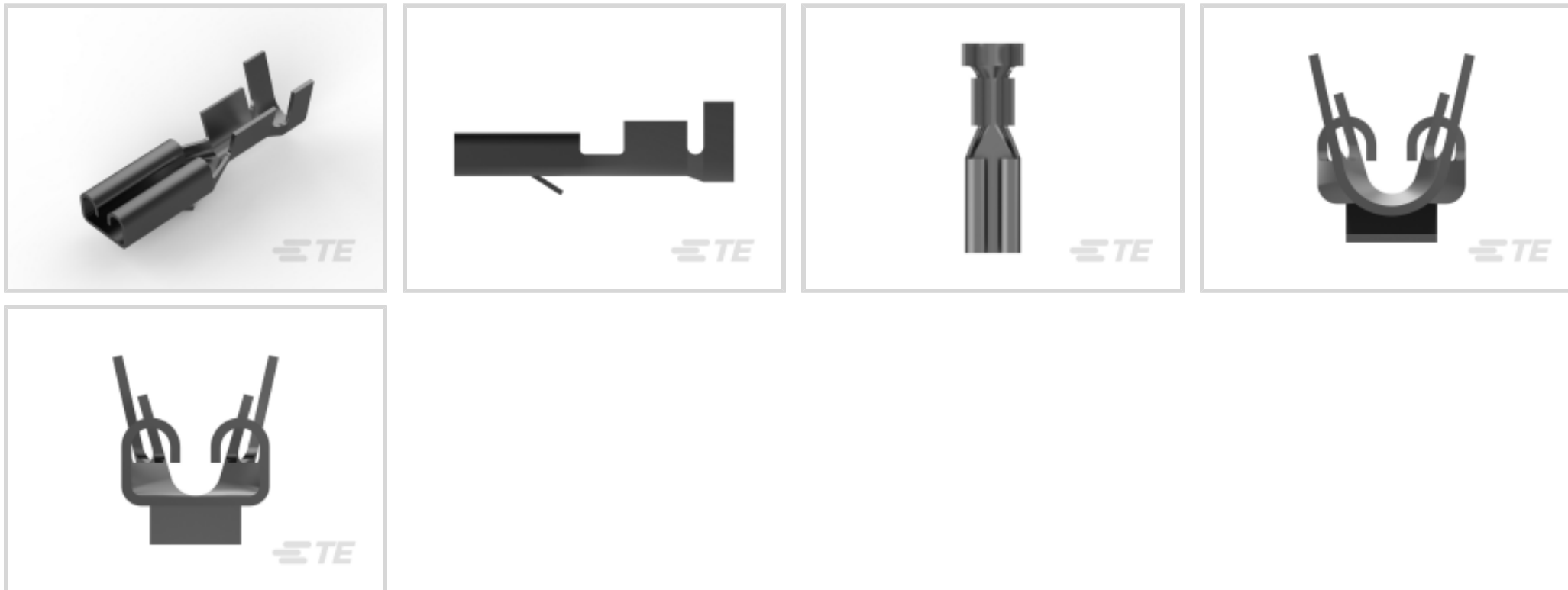

Quick Disconnect Terminal Type: **Receptacle**

Wire Size: .51 – 1.65 mm²

Mating Tab Width: 2.8 mm [.11 in]

Mating Tab Thickness: .81 mm [.032 in]

Features

Product Type Features

Insertion Force	Normal
-----------------	--------

Configuration Features

Connection Capacity	Single
Compatible With Wire & Cable Type	Discrete Wire

Contact Features

Quick Disconnect Terminal Type	Receptacle
Mating Tab Width	2.8 mm [.11 in]
Mating Tab Thickness	.81 mm [.032 in]
Terminal Orientation	Straight
Contact Base Material	Phosphor Bronze
Terminal Plating Material	Pre-Tin
Crimp Type	F-Crimp
Barrel Type	Open

Termination Features

--	--



Product Terminates To	Wire & Cable
-----------------------	--------------

Mechanical Attachment

	.038 in
--	---------

Wire Insulation Support	With
-------------------------	------

Mating Retention Type	Locking Lance
-----------------------	---------------

Dimensions

Terminal Material Thickness	.25 mm[.01 in]
-----------------------------	----------------

Product Length	14 mm[.551 in]
----------------	----------------

Compatible Insulation Diameter Range	2.01 – 3.1 mm[.079 – .122 in]
--------------------------------------	-------------------------------

Wire Size	.51 – 1.65 mm ²
-----------	----------------------------

Usage Conditions

Insulation Option	Uninsulated
-------------------	-------------

Operating Temperature Range	-40 – 110 °C[-40 – 230 °F]
-----------------------------	----------------------------

Packaging Features

Packaging Quantity	10000
--------------------	-------

Packaging Method	Strip/Reel
------------------	------------

Product Compliance

[For compliance documentation, visit the product page on TE.com>](#)

EU RoHS Directive 2011/65/EU	Compliant
------------------------------	-----------

EU ELV Directive 2000/53/EC	Compliant
-----------------------------	-----------

China RoHS 2 Directive MIIT Order No 32, 2016	No Restricted Materials Above Threshold
---	---

EU REACH Regulation (EC) No. 1907/2006	Current ECHA Candidate List: JUNE 2024 (241) Candidate List Declared Against: JAN 2024 (240) Does not contain REACH SVHC
--	--

Halogen Content	Low Halogen - Br, Cl, F, I < 900 ppm per homogenous material. Also BFR/CFR/PVC Free
-----------------	---

Solder Process Capability	Not applicable for solder process capability
---------------------------	--

Product Compliance Disclaimer

This information is provided based on reasonable inquiry of our suppliers and represents our current actual knowledge based on the information they provided. This information is subject to change. The part numbers that TE has identified as EU RoHS compliant have a maximum concentration of 0.1% by weight in homogenous materials for lead, hexavalent chromium, mercury, PBB, PBDE, DBP, BBP, DEHP, DIBP, and 0.01% for cadmium, or qualify for an exemption to these

limits as defined in the Annexes of Directive 2011/65/EU (RoHS2). Finished electrical and electronic equipment products will be CE marked as required by Directive 2011/65/EU. Components may not be CE marked. Additionally, the part numbers that TE has identified as EU ELV compliant have a maximum concentration of 0.1% by weight in homogenous materials for lead, hexavalent chromium, and mercury, and 0.01% for cadmium, or qualify for an exemption to these limits as defined in the Annexes of Directive 2000/53/EC (ELV). Regarding the REACH Regulation, the information TE provides on SVHC in articles for this part number is based on the latest European Chemicals Agency (ECHA) 'Guidance on requirements for substances in articles' posted at this URL: <https://echa.europa.eu/guidance-documents/guidance-on-reach>

Compatible Parts



TE Part # 2150017-1
OCEAN_2.0_Applicator-E-070F130F-REM



KIT
TE Part # 7-2150017-7
OCEAN_2.0_SPARE_PART_KIT-070F130F



TE Part # 2150017-2
OCEAN_2.0_Applicator-E-070F130F-REA



TE Part # 737255-5
FF 110 REC 0.5-1.0MM2 TPBR-REA



TE Part # 7-2150017-1
OCEAN_2.0_Applicator-E-070F130F



TE Part # 7-2150017-2
OCEAN_2.0_Applicator-E-070F130F

Also in the Series | FASTIN-FASTON 110



Automotive Housings(6)



Automotive Terminals(5)

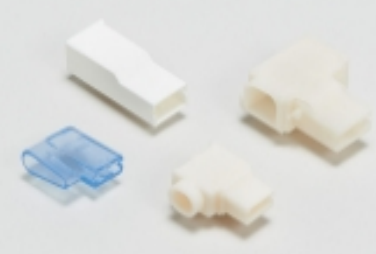

Crimp Terminal Housings(34)



Insertion & Extraction Tools(3)



Quick Disconnects(83)

Customers Also Bought

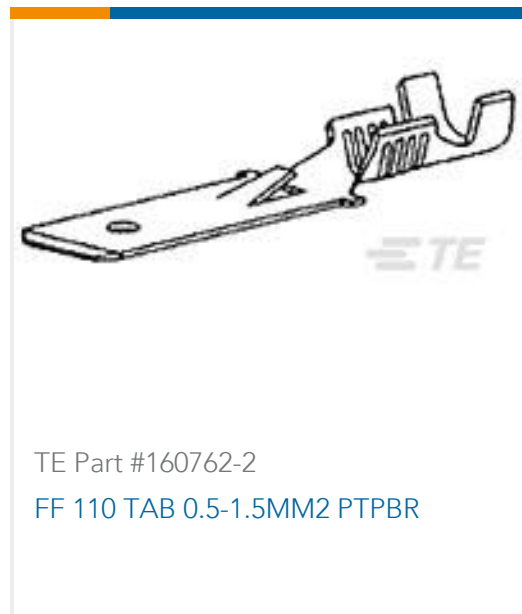

Documents

Product Drawings

FF 110 REC TERMINAL 20-15 AWG PTPPB

English

CAD Files

3D PDF

3D

Customer View Model

[ENG_CVM_CVM_160655-4_AJ.2d_dxf.zip](#)

English

Customer View Model

[ENG_CVM_CVM_160655-4_AJ.3d_igs.zip](#)

English

Customer View Model

[ENG_CVM_CVM_160655-4_AJ.3d_stp.zip](#)

English

By downloading the CAD file I accept and agree to the [Terms and Conditions](#) of use.

Product Specifications



EBGeneral Application Specification for Open Barrel Terminals**

English

Application Specification

English