

Sensor/actuator cable - SAC-8P-M12MR/ 1,5-PUR SH



1522817

<https://www.phoenixcontact.com/pc/products/1522817>

Please be informed that the data shown in this PDF document is generated from our Online Catalog. Please find the complete data in the user documentation. Our General Terms of Use for Downloads are valid.



Sensor/actuator cable, 8-position, PUR halogen-free, black-gray RAL 7021, shielded, Plug angled M12, coding: A, on free cable end, cable length: 1.5 m

Your advantages

- Easy and safe: 100% electrically tested plug-in components
- Reliable signal transmission – 360° shielding in environments with electromagnetic interference

Commercial Data

Item number	1522817
Packing unit	1 pc
Minimum order quantity	1 pc
Product Key	BF1CMA
Catalog Page	Page 211 (C-2-2019)
GTIN	4017918957605
Weight per Piece (including packing)	98.2 g
Weight per Piece (excluding packing)	96.6 g
Customs tariff number	85444290
Country of origin	PL

1522817

<https://www.phoenixcontact.com/pc/products/1522817>

Technical Data

Product properties

Product type	Sensor/actuator cable
Number of positions	8
Application	Standard
No. of cable outlets	1
Shielded	yes
Coding	A - standard

Insulation characteristics

Overvoltage category	II
Degree of pollution	3

Material specifications

Flammability rating according to UL 94	HB
Material of grip body	TPU, hardly inflammable, self-extinguishing
Contact material	CuZn
Contact surface material	Ni/Au
Contact carrier material	TPU GF
Material for screw connection	Zinc die-cast, nickel-plated

Electrical properties

Contact resistance	$\leq 5 \text{ m}\Omega$
Insulation resistance	$\geq 100 \text{ M}\Omega$
Nominal voltage U_N	30 V AC
	30 V DC
Nominal current I_N	2 A
Protective circuit	unwired

Mechanical properties

Mechanical data

Insertion/withdrawal cycles	≥ 100
-----------------------------	------------

LED signaling

Status display	No
Status display present	No

Connection data

Conductor connection

Tightening torque	0.4 Nm (M12 connector)
-------------------	------------------------

Connector

Sensor/actuator cable - SAC-8P-M12MR/ 1,5-PUR SH



1522817

<https://www.phoenixcontact.com/pc/products/1522817>

Connection 1

Head design	Plug
Head cable outlet	angled
Head thread type	M12
Coding	A

Connection 2

Head design	free cable end
-------------	----------------

Cable / line

Cable length	1.5 m
--------------	-------

PUR halogen-free black [PUR]

Dimensional drawing	
Cable weight	53 kg/km
UL AWM Style	20549 / 10493 (80°C/300 V)
Number of positions	8
Shielded	yes
Cable type	PUR halogen-free black [PUR]
Conductor structure signal line	32x 0.10 mm
AWG signal line	24
Conductor cross section	8x 0.25 mm ² (Signal line)
Wire diameter incl. insulation	1.17 mm ±0.02 mm
External cable diameter	5.9 mm ±0.2 mm
Outer sheath, material	PUR
External sheath, color	black-gray RAL 7021
Conductor material	Bare Cu litz wires
Material wire insulation	PP
Single wire, color	brown, white, green, yellow, gray, pink, blue, red
Thickness, insulation	approx. 0.2 mm
Thickness, outer sheath	approx. 0.5 mm
Overall twist	8 wires around filler to the core
Optical shield covering	85 %
Max. conductor resistance	≤ 78 Ω/km (at 20 °C)
Insulation resistance	≥ 1 GΩ*km (at 20 °C)
Nominal voltage, cable	≤ 300 V AC
Test voltage	≥ 3000 V AC (Spark test)

Sensor/actuator cable - SAC-8P-M12MR/ 1,5-PUR SH



1522817

<https://www.phoenixcontact.com/pc/products/1522817>

Test voltage Core/Shield	≥ 2000 V AC (for 60 s)
Minimum bending radius, fixed installation	5 x D
Minimum bending radius, flexible installation	10 x D
Max. bending cycles	2000000
Halogen-free	in accordance with DIN VDE 0472 part 815 according to IEC 60754-1
Flame resistance	in acc. with UL FT-2 according to UL 758/1581 (horizontal) in accordance with UL 758/1581 FT2 According to DIN EN 60332-2-2 (20 s)
Resistance to oil	in accordance with IEC 60811-404
Other resistance	hydrolysis and microbe resistant Resistant to salt water low-abrasion partly UV-resistant in accordance with DIN EN ISO 4892-2-A
Special properties	Flexible cable conduit capable
Ambient temperature (operation)	-40 °C ... 80 °C (cable, fixed installation) -25 °C ... 80 °C (Cable, flexible installation)

Ambient conditions

Degree of protection	IP65 IP67
Ambient temperature (operation)	-25 °C ... 90 °C (Plug / socket) -25 °C ... 80 °C (cable, fixed installation) -5 °C ... 80 °C (Cable, flexible installation)

Standards and regulations

Standards/specifications	IEC 61076-2-101
--------------------------	-----------------

1522817

<https://www.phoenixcontact.com/pc/products/1522817>

Drawings

Circuit diagram

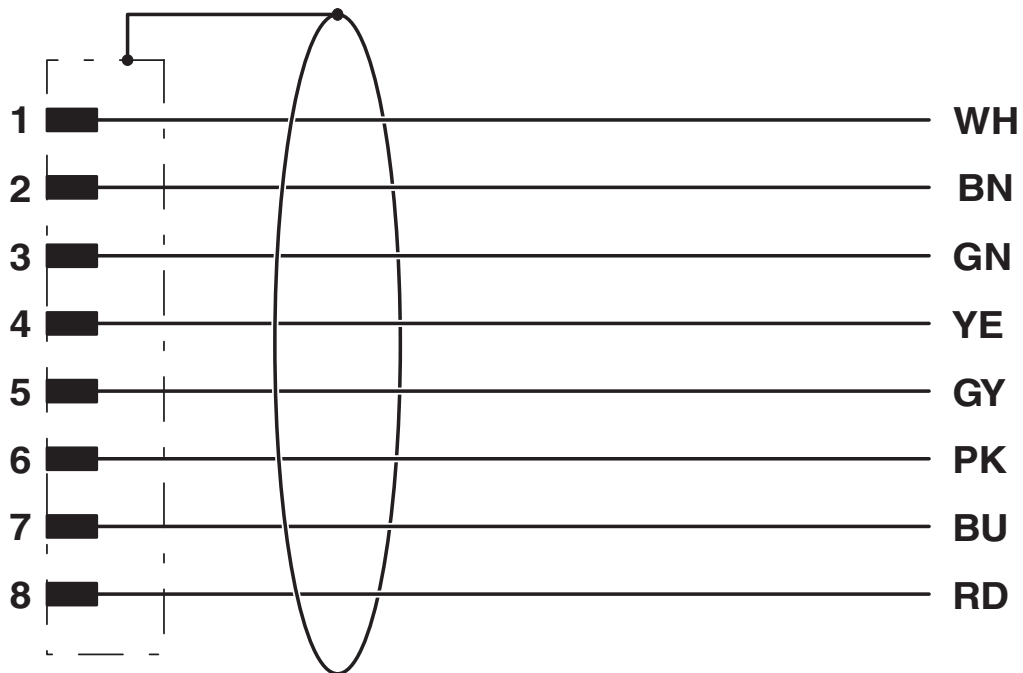

Schematic diagram

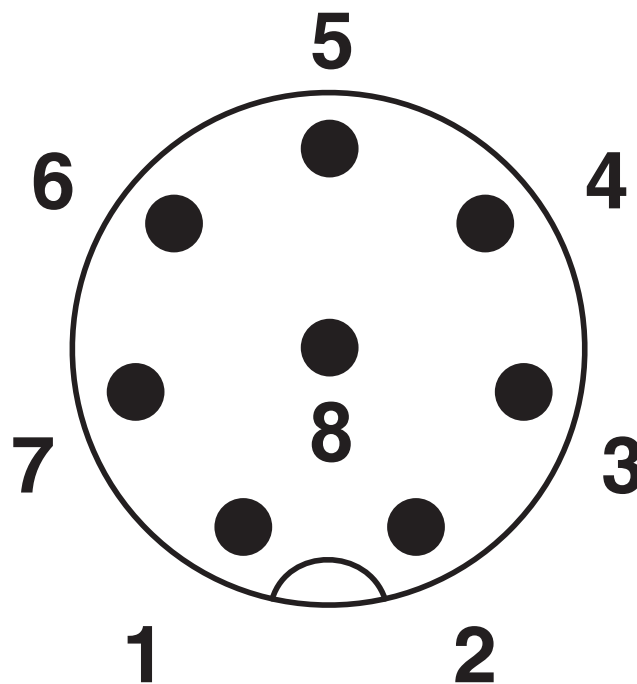

Pin assignment M12 plug, 8-pos., view plug side

Sensor/actuator cable - SAC-8P-M12MR/ 1,5-PUR SH

1522817

<https://www.phoenixcontact.com/pc/products/1522817>

Dimensional drawing

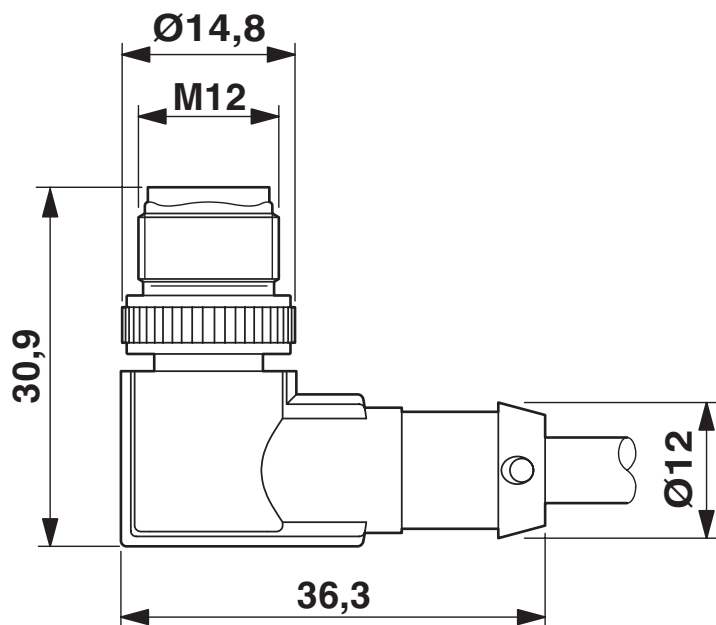

M12 x 1 male plug, angled, shielded

Sensor/actuator cable - SAC-8P-M12MR/ 1,5-PUR SH





1522817

<https://www.phoenixcontact.com/pc/products/1522817>

Approvals

 UL Listed Approval ID: FILE E 221474				
	Nominal Voltage U_N	Nominal Current I_N	Cross Section AWG	Cross Section mm^2
	30 V	2 A	-	-

 cUL Listed Approval ID: FILE E 221474				
	Nominal Voltage U_N	Nominal Current I_N	Cross Section AWG	Cross Section mm^2
	30 V	2 A	-	-

 EAC Approval ID: RU D-DE.HB35.B.00387				
---	--	--	--	--

cULus Listed				
---------------------	--	--	--	--

Sensor/actuator cable - SAC-8P-M12MR/ 1,5-PUR SH



1522817

<https://www.phoenixcontact.com/pc/products/1522817>

Classifications

ECLASS

ECLASS-9.0	27060311
ECLASS-10.0.1	27060311
ECLASS-11.0	27060311

ETIM

ETIM 8.0	EC001855
----------	----------

UNSPSC

UNSPSC 21.0	26121600
-------------	----------

Sensor/actuator cable - SAC-8P-M12MR/ 1,5-PUR SH



1522817

<https://www.phoenixcontact.com/pc/products/1522817>

Environmental Product Compliance

China RoHS	Environmentally friendly use period: unlimited = EFUP-e
	No hazardous substances above threshold values

1522817

<https://www.phoenixcontact.com/pc/products/1522817>

Accessories

Sealing cap

Sealing cap - PROT-M12 FS-PA-CHAIN - 1430873

<https://www.phoenixcontact.com/pc/products/1430873>

M12 sealing cap made of plastic with fixing band, for sensor cables, for free M12 plugs



Locking clip

Locking clip - SAC-M12-EXCLIP-M - 1558988

<https://www.phoenixcontact.com/pc/products/1558988>

Locking clip for the pin side of sensor/actuator cables with M12 connector and M12 connectors for assembly, for knurl diameter: 15 mm or for Allen key with a wrench size of 14 mm, prevents the disconnection of plug-in connections without tools



1522817

<https://www.phoenixcontact.com/pc/products/1522817>

Insert label

Insert label - PABA WH/23 - 1013779

<https://www.phoenixcontact.com/pc/products/1013779>



Insert label, Strip, white, unlabeled, can be labeled with: CMS-P1-PLOTTER, mounting type: slide-on, cable diameter range: 1.5 ... 35 mm, lettering field size: 23 x 4 mm, Number of individual labels: 20

Insert label

Insert label - PABA YE/23 - 1013782

<https://www.phoenixcontact.com/pc/products/1013782>



Insert label, Strip, yellow, unlabeled, can be labeled with: CMS-P1-PLOTTER, mounting type: slide-on, cable diameter range: 1.5 ... 35 mm, lettering field size: 23 x 4 mm, Number of individual labels: 20

Sensor/actuator cable - SAC-8P-M12MR/ 1,5-PUR SH



1522817

<https://www.phoenixcontact.com/pc/products/1522817>

Marker pen

Marker pen - B-STIFT - 1051993

<https://www.phoenixcontact.com/pc/products/1051993>



Marker pen, for manual labeling of unprinted Zack strips, smear-proof and waterproof, line thickness 0.5 mm

Diagonal cutter

Diagonal cutter - CUTFOX-S VDE - 1212207

<https://www.phoenixcontact.com/pc/products/1212207>



Diagonal cutter for hard (piano wire) and soft wires, VDE 1000 V AC/1500 V DC tested

Sensor/actuator cable - SAC-8P-M12MR/ 1,5-PUR SH



1522817

<https://www.phoenixcontact.com/pc/products/1522817>

Stripping tool

Stripping tool - WIREFOX SAC-1 - 1212757

<https://www.phoenixcontact.com/pc/products/1212757>



Stripping pliers, for halogen-free sensor/actuator cables (SAC cables), with PUR and PVC insulation, from Ø of 3.2 to 4.4 mm, any stripping length

Stripping tool

Stripping tool - WIREFOX SAC - 1212623

<https://www.phoenixcontact.com/pc/products/1212623>



Stripping pliers, for halogen-free sensor/actuator cables (SAC cables), with PUR and PVC insulation, from Ø of 4.4 to 7 mm, any stripping length

Sensor/actuator cable - SAC-8P-M12MR/ 1,5-PUR SH



1522817

<https://www.phoenixcontact.com/pc/products/1522817>

Stripping tool

Stripping tool - WIREFOX 10 - 1212150

<https://www.phoenixcontact.com/pc/products/1212150>



Stripping tool, for cables and conductors from 0.02 - 10 mm², self-adjusting, stripping length of up to 18 mm, cutting capacity of up to 10 mm² stranded/1.5 mm² solid, replaceable stripping blade

Protective hose adapter

Protective hose adapter - WP-CTA POM 13,0 BK - 1422884

<https://www.phoenixcontact.com/pc/products/1422884>



Protective hose adapter, for corrugated hoses with a nominal size of 13 (10 x 13), corrugated in parallel

1522817

<https://www.phoenixcontact.com/pc/products/1522817>

Protective hose

Protective hose - WP-PA HF 13,0 BK - 3240681

<https://www.phoenixcontact.com/pc/products/3240681>



Protective hose, material: PA 6, UV-resistant: yes, flexible, degree of protection: IP68, color: black, flammability rating in acc. with UL 94: V0, inner diameter: 10 mm, Total length: 50 m

Protective hose

Protective hose - WP-PA HF-HB 13,0 BK - 3240839

<https://www.phoenixcontact.com/pc/products/3240839>



Protective hose, material: PA 6, UV-resistant: yes, flexible, degree of protection: IP68, color: black, flammability rating in acc. with UL 94: HB, inner diameter: 10 mm, Total length: 50 m

Sensor/actuator cable - SAC-8P-M12MR/ 1,5-PUR SH



1522817

<https://www.phoenixcontact.com/pc/products/1522817>

Torque screwdriver

Torque screwdriver - TSD 04 SAC - 1208429

<https://www.phoenixcontact.com/pc/products/1208429>



Torque screwdriver, with preset torque of 0.4 Nm and 4 mm hexagonal drive for M12 connectors

Torque screwdriver

Torque screwdriver - TSD-M 1,2NM - 1212224

<https://www.phoenixcontact.com/pc/products/1212224>



Torque screw driver, accuracy as per EN ISO 6789 standard, adjustable from 0.3 - 1.2 Nm

Sensor/actuator cable - SAC-8P-M12MR/ 1,5-PUR SH



1522817

<https://www.phoenixcontact.com/pc/products/1522817>

Adapter insert

Adapter insert - TSD-M SAC-BIT ADAPTER - 1212600

<https://www.phoenixcontact.com/pc/products/1212600>



Adapter bit for TSD-M...torque tools, E6.3-1/4" drive with 4 mm hexagon to accommodate SAC bits

Tool

Tool - SAC BIT M12-D15 - 1208432

<https://www.phoenixcontact.com/pc/products/1208432>



Nut for assembling sensor/actuator cables with M12 connector and M12 connectors for assembly, with a knurl diameter of 15 mm, for 4 mm hexagonal drive

Phoenix Contact 2022 © - all rights reserved
<https://www.phoenixcontact.com>

PHOENIX CONTACT GmbH & Co. KG
Flachsmarktstraße 8
D-32825 Blomberg
+49 (0) 5235-3 00
info@phoenixcontact.com