

Flush-type connector - SACC-CI-M12FS-5CON-SH TOR 32



1457652

<https://www.phoenixcontact.com/pc/products/1457652>

Please be informed that the data shown in this PDF document is generated from our Online Catalog. Please find the complete data in the user documentation. Our General Terms of Use for Downloads are valid.



Sensor/actuator flush-type socket, 5-pos., A-coded, with straight THR solder connection, only contact insert

Your advantages

- Reduced mounting costs thanks to two-piece device connector
- Packaging available for automated pick and place assembly
- All common pin assignments and codings available
- Easy device integration thanks to mechanical port screw connections with threaded attachment, press-in contour or direct integration in the front plate
- Additional gasket for the device when not plugged in

Flush-type connector - SACC-CI-M12FS-5CON-SH TOR 32



1457652

<https://www.phoenixcontact.com/pc/products/1457652>

Commercial Data

Item number	1457652
Packing unit	100 pc
Minimum order quantity	100 pc
Note	Made to Order (non-returnable)
Product Key	ABQCBF
Catalog Page	Page 257 (C-2-2013)
GTIN	4046356617406
Weight per Piece (including packing)	6.877 g
Weight per Piece (excluding packing)	6.6 g
Customs tariff number	85366990
Country of origin	DE

Flush-type connector - SACC-CI-M12FS-5CON-SH TOR 32



1457652

<https://www.phoenixcontact.com/pc/products/1457652>

Technical Data

Notes

Notes on operation	The electrical and mechanical data specified assume that the connector pair is correctly locked and mounted. If the connector is unlocked and if there is a danger of contamination, the connector must be sealed using a protective cap > IP54. Influences arising from litz wires, cables or PCB assembly must also be taken into consideration.
--------------------	--

Product properties

Product type	Contact insert
Number of positions	5
Shielded	yes
Coding	A - standard

Insulation characteristics

Overvoltage category	III
Degree of pollution	3

Electrical properties

Rated surge voltage	1.5 kV
Contact resistance	$\leq 3 \text{ m}\Omega$
Insulation resistance	$\geq 100 \text{ M}\Omega$
Nominal voltage U_N	60 V
Nominal current I_N	4 A

Material specifications

Flammability rating according to UL 94	V0
Sealing material	FKM
Contact material	CuZn
Contact surface material	Ni/Au
Contact carrier material	PA

Connector

Insertion/withdrawal cycles	> 100
-----------------------------	-------

Header 1

Head design	Socket
Head cable outlet	straight
Coding	A-coded

Environmental and real-life conditions

Ambient conditions

Degree of protection (when plugged in)	IP67 (correctly plugged in and locked)
Degree of protection	IP67 (correctly plugged in and locked)

Flush-type connector - SACC-CI-M12FS-5CON-SH TOR 32



1457652

<https://www.phoenixcontact.com/pc/products/1457652>

Degree of protection	IP67, when plugged in
Ambient temperature (operation)	-25 °C ... 85 °C
	-40 °C ... 85 °C (without mechanical actuation)

Standards and regulations

M12

Standards/specifications	IEC 61076-2-101
--------------------------	-----------------

Mounting

Mounting type	PCB mounting
---------------	--------------

Packaging specifications

Type of packaging	Belt
Delivery state	with assembly pad

Flush-type connector - SACC-CI-M12FS-5CON-SH TOR 32

1457652

<https://www.phoenixcontact.com/pc/products/1457652>

Drawings

Schematic diagram

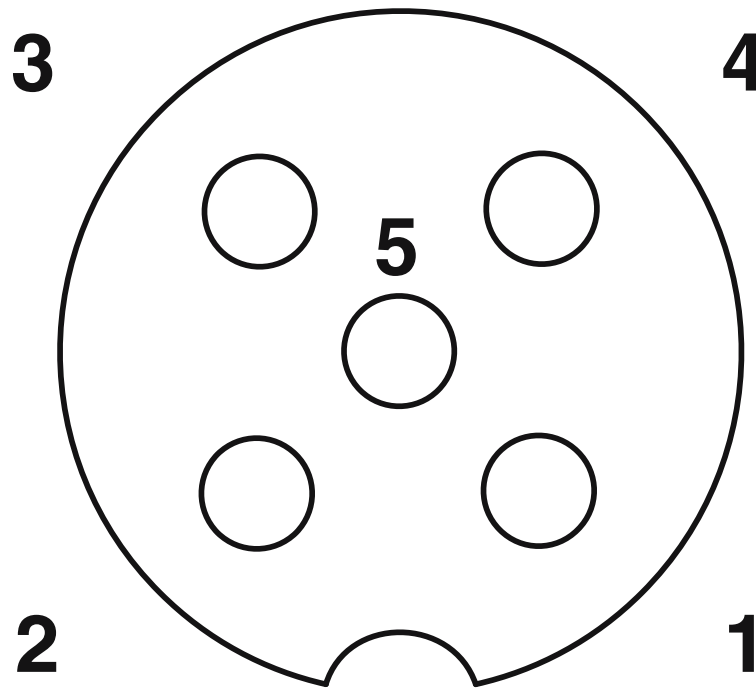

Pin assignment M12 socket, 5-pos., A-coded, socket side view

Dimensional drawing

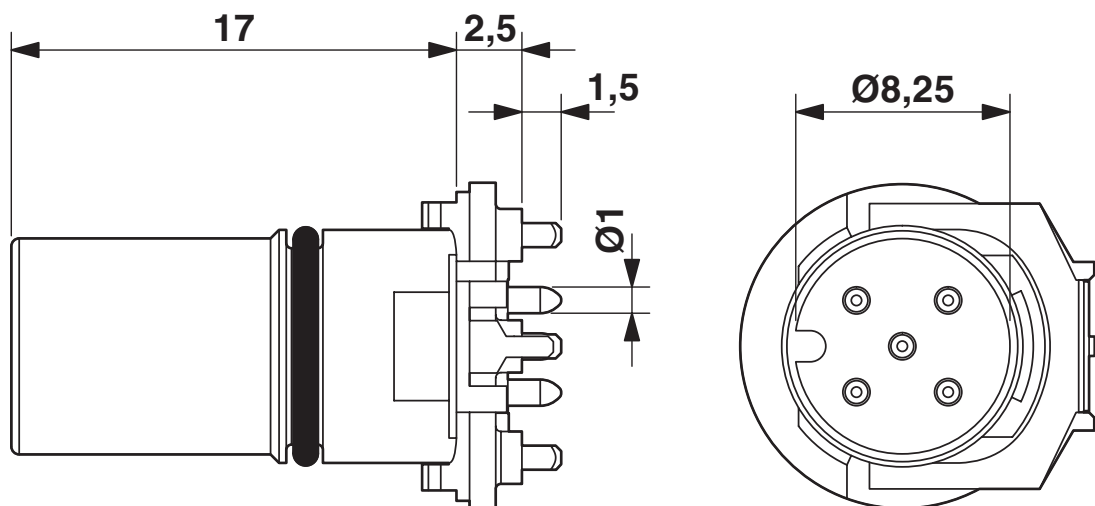

M12 female connector contact carrier

Flush-type connector - SACC-CI-M12FS-5CON-SH TOR 32



1457652

<https://www.phoenixcontact.com/pc/products/1457652>

Drilling plan/solder pad geometry

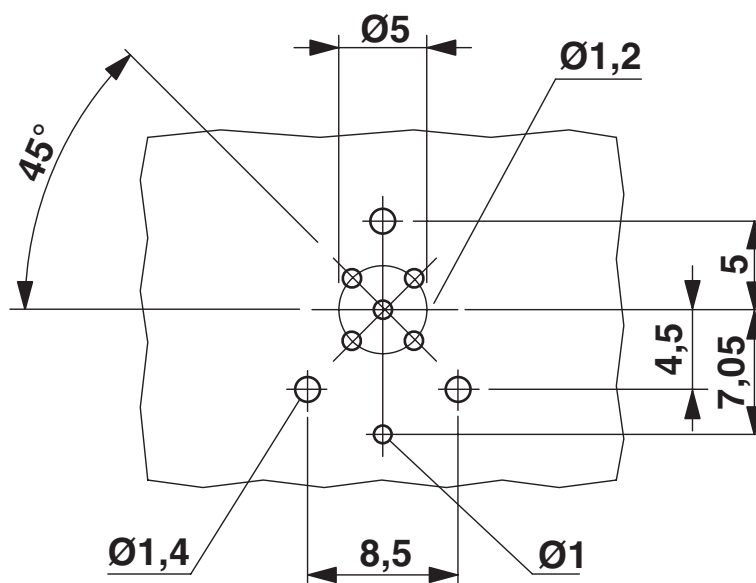

Drilling diagram

Flush-type connector - SACC-CI-M12FS-5CON-SH TOR 32





1457652

<https://www.phoenixcontact.com/pc/products/1457652>

Approvals

 cUL Recognized Approval ID: FILE E 118976				
	Nominal Voltage U_N	Nominal Current I_N	Cross Section AWG	Cross Section mm^2
	60 V	4 A	- 22	-

 UL Recognized Approval ID: FILE E 118976				
	Nominal Voltage U_N	Nominal Current I_N	Cross Section AWG	Cross Section mm^2
	60 V	4 A	- 22	-

 EAC Approval ID: B.01687				
--	--	--	--	--

 cULus Recognized Approval ID: E221474-20140616				
	Nominal Voltage U_N	Nominal Current I_N	Cross Section AWG	Cross Section mm^2
	60 V	4 A	22 - 20	-

cULus Recognized				
-------------------------	--	--	--	--

Flush-type connector - SACC-CI-M12FS-5CON-SH TOR 32



1457652

<https://www.phoenixcontact.com/pc/products/1457652>

Classifications

ECLASS

ECLASS-9.0	27440102
ECLASS-10.0.1	27440102
ECLASS-11.0	27440102

ETIM

ETIM 8.0	EC002635
----------	----------

UNSPSC

UNSPSC 21.0	39121400
-------------	----------

Flush-type connector - SACC-CI-M12FS-5CON-SH TOR 32



1457652

<https://www.phoenixcontact.com/pc/products/1457652>

Environmental Product Compliance

REACH SVHC	Lead 7439-92-1
China RoHS	Environmentally Friendly Use Period = 50 years
	For information on hazardous substances, refer to the manufacturer's declaration available under "Downloads"

Flush-type connector - SACC-CI-M12FS-5CON-SH TOR 32



1457652

<https://www.phoenixcontact.com/pc/products/1457652>

Accessories

Screw plug

Screw plug - PROT-M12 - 1680539

<https://www.phoenixcontact.com/pc/products/1680539>



An M12 screw plug for the unoccupied M12 sockets of the sensor/actuator cable, boxes and flush-type connectors

Housing screw connection

Housing screw connection - SACC-M12-SCO NUT - 1552243

<https://www.phoenixcontact.com/pc/products/1552243>



M12 SPEEDCON housing screw connection for M12 female inserts, with O-ring, for all SPEEDCON-capable THR and wave soldering contact carriers

Flush-type connector - SACC-CI-M12FS-5CON-SH TOR 32

1457652

<https://www.phoenixcontact.com/pc/products/1457652>

Screw plug

Screw plug - PROT-M12 SH - 1503302

<https://www.phoenixcontact.com/pc/products/1503302>



An M12 screw plug for the unoccupied M12 sockets of the shielded sensor/actuator cable, boxes and flush-type connectors

Housing screw connection

Housing screw connection - SACC-DSIV-M12-NUT - 1416144

<https://www.phoenixcontact.com/pc/products/1416144>



Housing screw connection with M12 standard thread, with O-ring, for the two-piece straight M12 THR contact carrier and for the two-piece angled M12 contact carrier

Flush-type connector - SACC-CI-M12FS-5CON-SH TOR 32

1457652

<https://www.phoenixcontact.com/pc/products/1457652>

Screw plug

Screw plug - PROT-M12 FB - 1555538

<https://www.phoenixcontact.com/pc/products/1555538>



M12 high-grade steel screw plug, for unoccupied M12 sockets of the sensor/actuator cables, boxes and flush-type connectors for the food industry

Housing screw connection

Housing screw connection - SACC-M12-SCO NUT L 90 - 1432460

<https://www.phoenixcontact.com/pc/products/1432460>



M12-SPEEDCON housing screw connection for M12 female inserts, with flat gasket, for all Speedcon-compatible THR and wave soldering contact carriers

Flush-type connector - SACC-CI-M12FS-5CON-SH TOR 32

1457652

<https://www.phoenixcontact.com/pc/products/1457652>

Sample set

Sample set - SACC-CIM12FS5PL180THRSHSAMPLE - 1413558

<https://www.phoenixcontact.com/pc/products/1413558>



Sensor/actuator flush-type socket, 5-pos., A-coded, with straight THR solder connection, only contact insert

Housing screw connection

Housing screw connection - SACC-BP-F-M12/M15-6-THR - 1414004

<https://www.phoenixcontact.com/pc/products/1414004>



Housing screw connection, Socket, M12, Rear mounting, M15 x 1

Flush-type connector - SACC-CI-M12FS-5CON-SH TOR 32

1457652

<https://www.phoenixcontact.com/pc/products/1457652>

Housing screw connection

Housing screw connection - SACC-BP-F-M12/M15-7-THR - 1414003

<https://www.phoenixcontact.com/pc/products/1414003>



Housing screw connection, Socket, M12, Rear mounting, M15 x 1

Housing screw connection

Housing screw connection - SACC-BP-F-M12/M15-6-THR SCO - 1414020

<https://www.phoenixcontact.com/pc/products/1414020>



Housing screw connection, Socket, M12-SPEEDCON, Rear mounting, M15 x 1

Flush-type connector - SACC-CI-M12FS-5CON-SH TOR 32

1457652

<https://www.phoenixcontact.com/pc/products/1457652>

Housing screw connection

Housing screw connection - SACC-BP-F-M12/M15-7-THR SCO - 1414005

<https://www.phoenixcontact.com/pc/products/1414005>



Housing screw connection, Socket, M12-SPEEDCON, Rear mounting, M15 x 1

Housing screw connection

Housing screw connection - SACC-BP-F-M12/THR-1,0/1,8-9TIP - 1419630

<https://www.phoenixcontact.com/pc/products/1419630>



M12 threaded sleeve with tolerance-compensating function, for straight, THR solderable M12 socket contact inserts. Suitable for 1.0 mm ... 1.8 mm thick front plates.

Flush-type connector - SACC-CI-M12FS-5CON-SH TOR 32

1457652

<https://www.phoenixcontact.com/pc/products/1457652>

Housing screw connection

Housing screw connection - SACC-BP-F-M12/THR-1,7/2,5-9TIP - 1419631

<https://www.phoenixcontact.com/pc/products/1419631>



M12 threaded sleeve with tolerance-compensating function, for straight, THR solderable M12 socket contact inserts. Suitable for 1.7 mm ... 2.5 mm thick front plates.

Housing screw connection

Housing screw connection - SACC-BP-F-M12/THR-2,4/3,2-9TIP - 1419633

<https://www.phoenixcontact.com/pc/products/1419633>



M12 threaded sleeve with tolerance-compensating function, for straight, THR solderable M12 socket contact inserts. Suitable for 2.4 mm ... 3.2 mm thick front plates.

Flush-type connector - SACC-CI-M12FS-5CON-SH TOR 32

1457652

<https://www.phoenixcontact.com/pc/products/1457652>

Housing screw connection

Housing screw connection - SACC-BP-F-M12/THR-3,1/3,9-9TIP - 1419634

<https://www.phoenixcontact.com/pc/products/1419634>



M12 threaded sleeve with tolerance-compensating function, for straight, THR solderable M12 socket contact inserts. Suitable for 3.1 mm ... 3.9 mm thick front plates.

Housing screw connection

Housing screw connection - SACC-M12 NUT PRESS - 1437889

<https://www.phoenixcontact.com/pc/products/1437889>



Housing screw connection for two-piece M12 connectors for the reflow soldering process.

Flush-type connector - SACC-CI-M12FS-5CON-SH TOR 32

1457652

<https://www.phoenixcontact.com/pc/products/1457652>

Housing screw connection

Housing screw connection - SACC-DSIV-M12-NUT-9 THR - 1417989

<https://www.phoenixcontact.com/pc/products/1417989>



M12 female connector, front mounting THR with M14 screw fastening

Housing screw connection

Housing screw connection - SACC-BP-F-M12-THR PP - 1027662

<https://www.phoenixcontact.com/pc/products/1027662>



Housing screw connection, Socket, M12-Push-Pull, Rear mounting, M16, THR- und Wellenlötkontakte

Flush-type connector - SACC-CI-M12FS-5CON-SH TOR 32



1457652

<https://www.phoenixcontact.com/pc/products/1457652>

Housing screw connection

Housing screw connection - SACC-FP-F-M12-THR PP - 1027678

<https://www.phoenixcontact.com/pc/products/1027678>



Housing screw connection, Socket, M12-Push-Pull, Front mounting, M14 x 1,
THR- und Wellenlötkontakte

Phoenix Contact 2022 © - all rights reserved

<https://www.phoenixcontact.com>

PHOENIX CONTACT GmbH & Co. KG

Flachsmarktstraße 8

D-32825 Blomberg

+49 (0) 5235-3 00

info@phoenixcontact.com