

Sensor/actuator cable - SAC-4P-M12MS/ 0,6-PVC/M12FS - 1415612

Please be informed that the data shown in this PDF Document is generated from our Online Catalog. Please find the complete data in the user's documentation. Our General Terms of Use for Downloads are valid (<http://phoenixcontact.com/download>)



Sensor/actuator cable, 4-position, PVC, black RAL 9005, Plug straight M12, coding: A, on Socket straight M12, coding: A, cable length: 0.6 m

Your advantages

- Easy and safe: 100% electrically tested plug-in components

Key Commercial Data

| | |
|--------------------------------------|---|
| Packing unit | 1 pc |
| GTIN |  4 055626 049861 |
| GTIN | 4055626049861 |
| Weight per Piece (excluding packing) | 40.000 g |
| Custom tariff number | 85444290 |
| Country of origin | Germany |

Technical data

Dimensions

| | |
|-----------------|-------|
| Length of cable | 0.6 m |
|-----------------|-------|

Ambient conditions

| | |
|---------------------------------|----------------------------------|
| Ambient temperature (operation) | -25 °C ... 90 °C (Plug / socket) |
| Degree of protection | IP65 |
| | IP67 |
| | IP68 |

General

| | |
|-----------------------|-----|
| Rated current at 40°C | 4 A |
|-----------------------|-----|

Sensor/actuator cable - SAC-4P-M12MS/ 0,6-PVC/M12FS - 1415612

Technical data

General

| | |
|------------------------------|-------------------------------|
| Rated voltage | 250 V AC |
| | 250 V DC |
| Number of positions | 4 |
| Insulation resistance | ≥ 10 MΩ |
| Coding | A - standard |
| Standards/regulations | M12 connector IEC 61076-2-101 |
| Status display | No |
| Protective circuit/component | unwired |
| Overvoltage category | II |
| Degree of pollution | 3 |
| Insertion/withdrawal cycles | ≥ 100 |
| Torque | 0.4 Nm |

Material

| | |
|--|---|
| Flammability rating according to UL 94 | HB |
| Contact material | CuSn |
| Contact surface material | Ni/Au |
| Contact carrier material | TPU GF |
| Material of grip body | TPU, hardly inflammable, self-extinguishing |
| Material, knurls | Zinc die-cast, nickel-plated |
| Sealing material | NBR |

Standards and Regulations

| | |
|--|-------------------------------|
| Standards/specifications | M12 connector IEC 61076-2-101 |
| Flammability rating according to UL 94 | HB |

Cable

| | |
|------------------------------------|---------------------------------------|
| Cable type | PVC black |
| Cable type (abbreviation) | PVC |
| Cable abbreviation | LiYY |
| UL AWM style | 2464 / 1729 (80°C/300 V) |
| Conductor cross section | 4x 0.34 mm ² (Signal line) |
| AWG signal line | 22 |
| Conductor structure signal line | 19x 0.15 mm |
| Core diameter including insulation | 1.26 mm ±0.05 mm |
| Thickness, insulation | ≥ 0.23 mm (Core insulation) |
| Wire colors | brown, white, blue, black |
| Overall twist | 4 wires, twisted |
| External sheath, color | black RAL 9005 |

Sensor/actuator cable - SAC-4P-M12MS/ 0,6-PVC/M12FS - 1415612

Technical data

Cable

| | |
|---|---|
| Outer sheath thickness | ≥ 0.76 mm |
| External cable diameter D | 4.7 mm ±0.15 mm |
| Minimum bending radius, fixed installation | 5 x D |
| Minimum bending radius, flexible installation | 10 x D |
| Cable weight | 40 kg/km |
| Outer sheath, material | PVC |
| Material conductor insulation | PVC |
| Conductor material | Bare Cu litz wires |
| Insulation resistance | ≥ 200 MΩ*km (at 20 °C) |
| Conductor resistance | ≤ 57 Ω/km (at 20 °C) |
| Nominal voltage, cable | ≤ 300 V |
| Test voltage, cable | ≥ 3000 V |
| Flame resistance | As per UL-Style 2464 |
| Resistance to oil | according to DIN EN 60811-2-1, 168 h at 60 °C |
| Ambient temperature (operation) | -40 °C ... 80 °C (cable, fixed installation) |
| | -25 °C ... 80 °C (cable, flexible installation) |

Environmental Product Compliance

| | |
|------------|---|
| China RoHS | Environmentally friendly use period: unlimited = EFUP-e |
| | No hazardous substances above threshold values |

Drawings

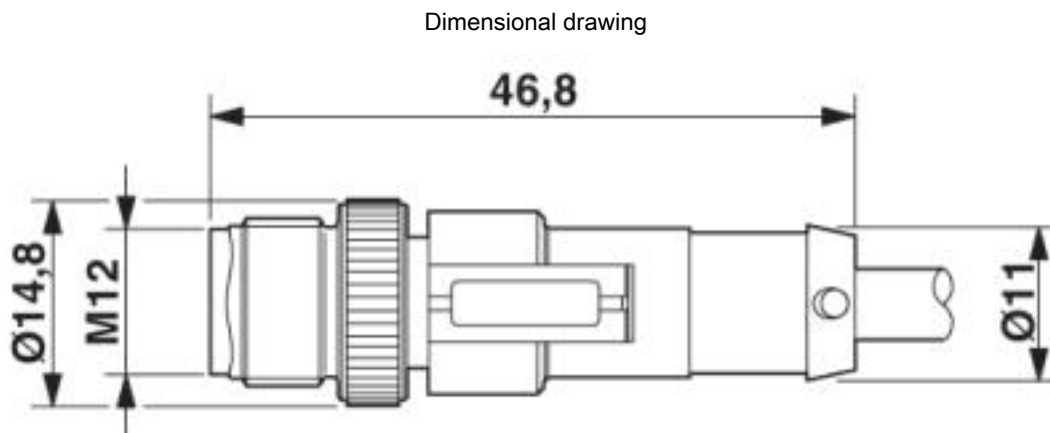

Plug, M12 x 1, straight, shielded

Sensor/actuator cable - SAC-4P-M12MS/ 0,6-PVC/M12FS - 1415612

Dimensional drawing

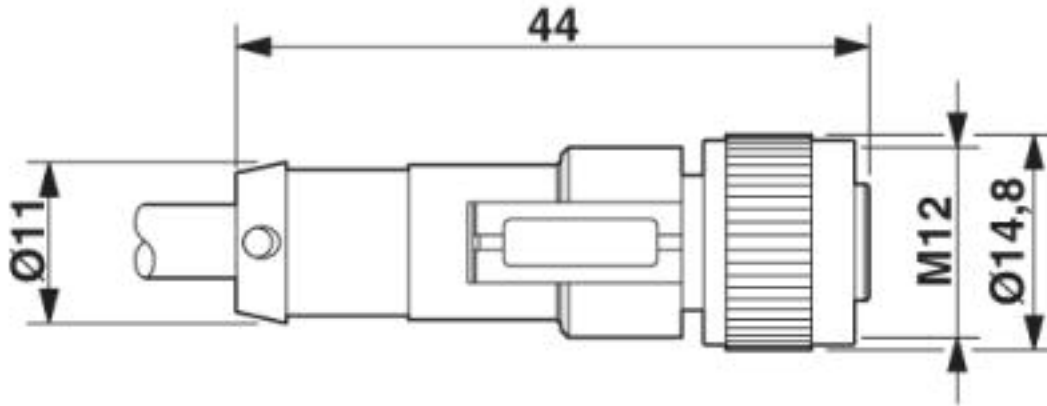

M12 x 1 socket, straight

Circuit diagram

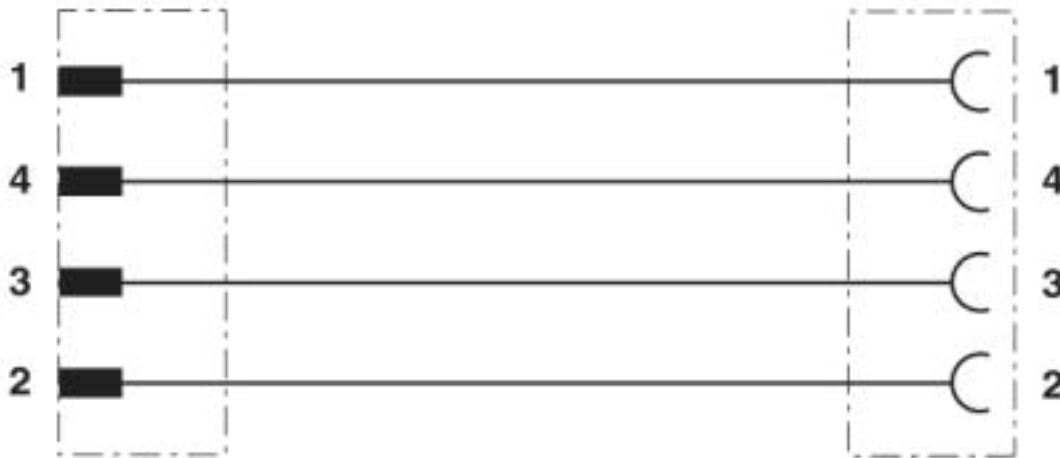

Contact assignment of the M12 plug and the M12 socket

Sensor/actuator cable - SAC-4P-M12MS/ 0,6-PVC/M12FS - 1415612

Schematic diagram

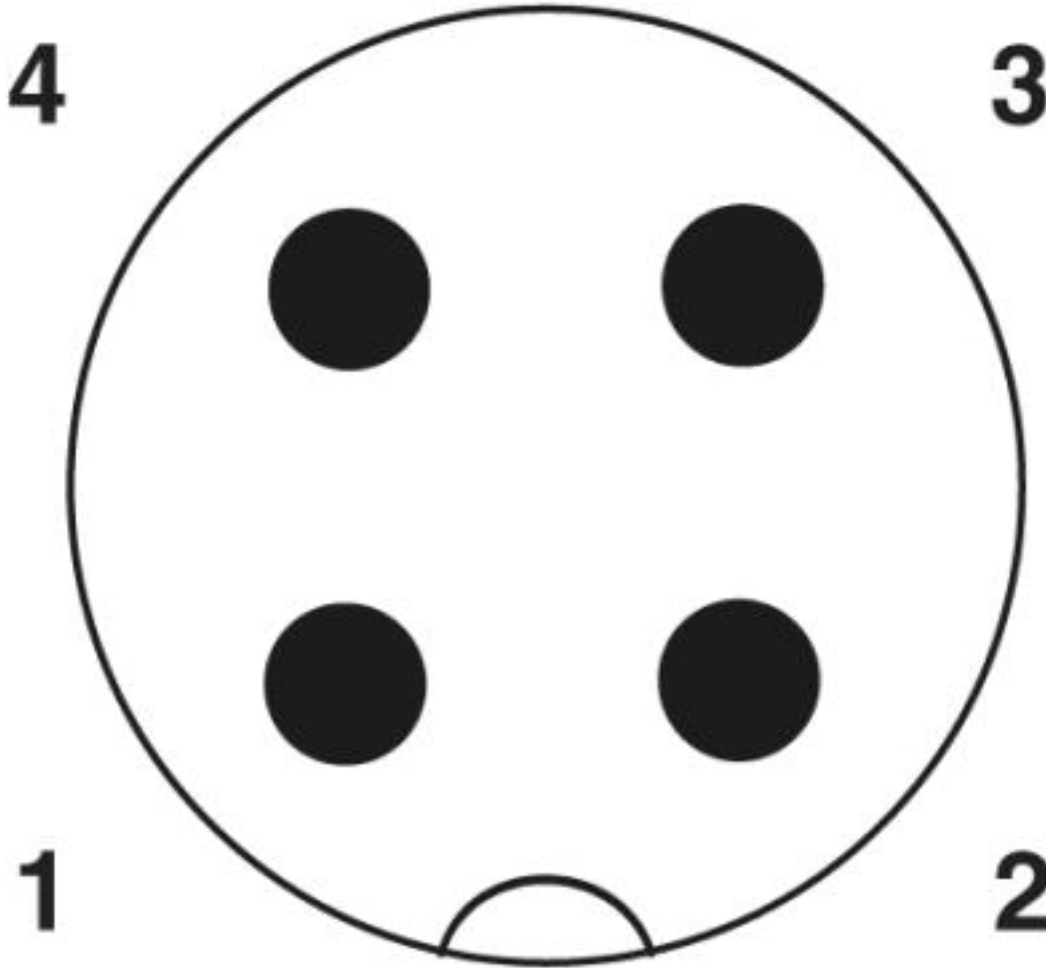

Pin assignment M12 plug, 4-pos., A-coded, view plug side

Sensor/actuator cable - SAC-4P-M12MS/ 0,6-PVC/M12FS - 1415612

Schematic diagram

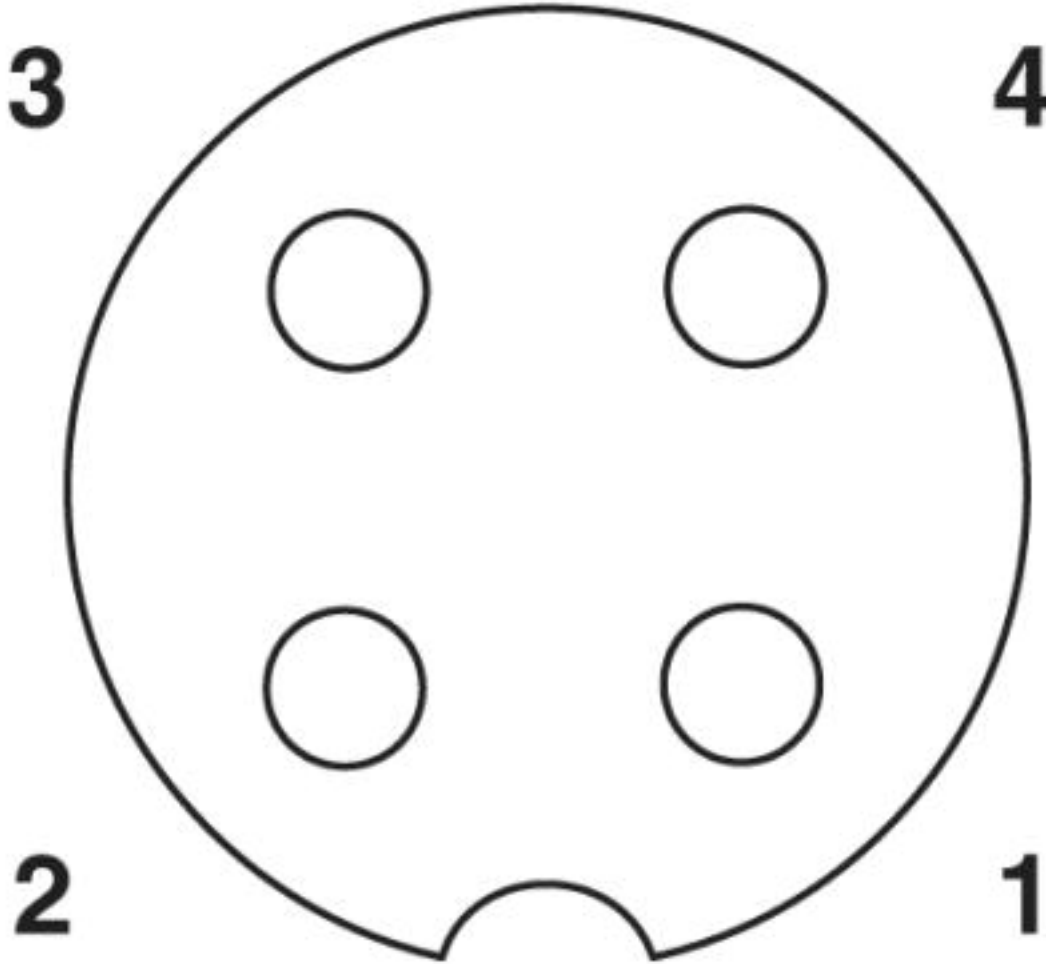

Pin assignment M12 socket, 4-pos., A-coded, view female side

Sensor/actuator cable - SAC-4P-M12MS/ 0,6-PVC/M12FS - 1415612

Cable cross section

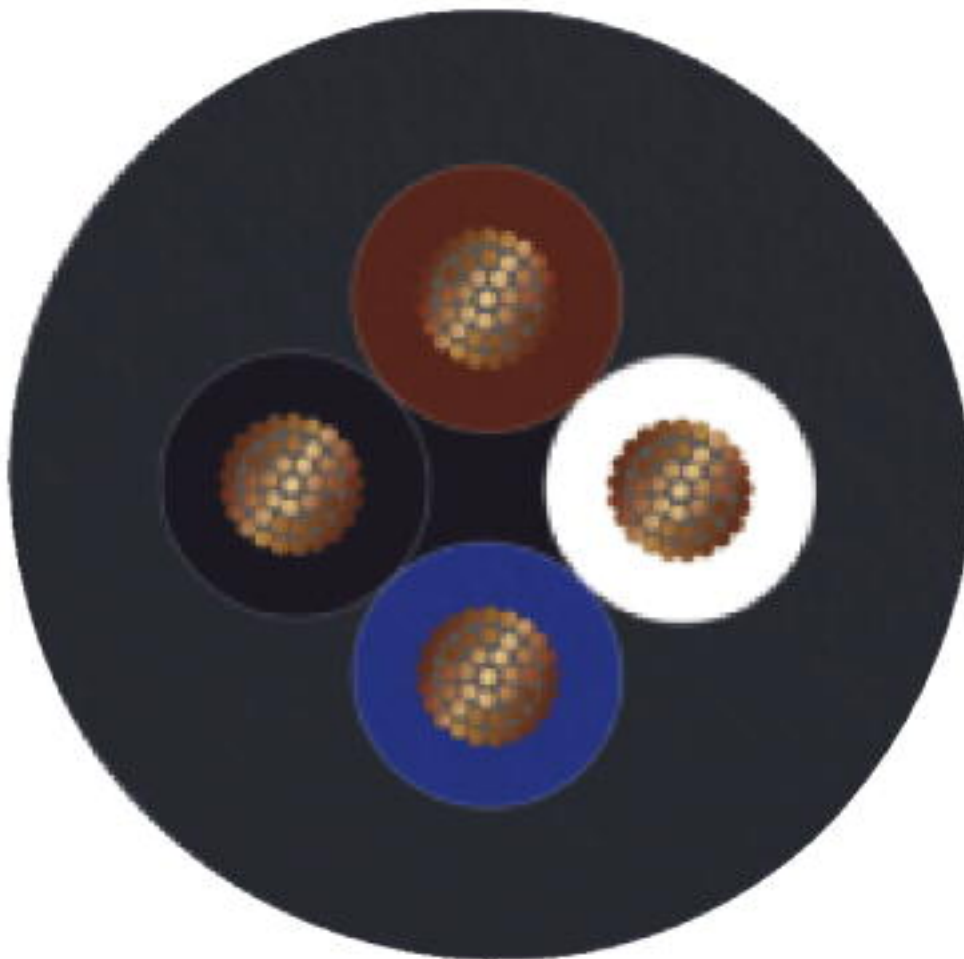

PVC black [PVC]

Classifications

eCl@ss

| | |
|------------|----------|
| eCl@ss 4.0 | 27060300 |
| eCl@ss 4.1 | 27060300 |
| eCl@ss 5.0 | 27061800 |
| eCl@ss 5.1 | 27061800 |
| eCl@ss 6.0 | 27279200 |
| eCl@ss 7.0 | 27279218 |
| eCl@ss 8.0 | 27279218 |

Sensor/actuator cable - SAC-4P-M12MS/ 0,6-PVC/M12FS - 1415612

Classifications

eCl@ss

| | |
|------------|----------|
| eCl@ss 9.0 | 27060311 |
|------------|----------|

ETIM

| | |
|----------|----------|
| ETIM 5.0 | EC001855 |
| ETIM 6.0 | EC001855 |
| ETIM 7.0 | EC001855 |

UNSPSC

| | |
|-------------|----------|
| UNSPSC 13.2 | 31251501 |
| UNSPSC 19.0 | 31251501 |
| UNSPSC 20.0 | 31251501 |
| UNSPSC 21.0 | 31251501 |

Approvals

Approvals

Approvals

UL Listed / cUL Listed / cULus Listed

Ex Approvals

Approval details

| | | | |
|--------------------|---|---|---------------|
| UL Listed |  | http://database.ul.com/cgi-bin/XYV/template/LISEXT/1FRAME/index.htm | FILE E 221474 |
| Nominal voltage UN | | 300 V | |
| Nominal current IN | | 4 A | |

| | | | |
|--------------------|---|---|---------------|
| cUL Listed |  | http://database.ul.com/cgi-bin/XYV/template/LISEXT/1FRAME/index.htm | FILE E 221474 |
| Nominal voltage UN | | 300 V | |
| Nominal current IN | | 4 A | |

Sensor/actuator cable - SAC-4P-M12MS/ 0,6-PVC/M12FS - 1415612

Approvals

cULus Listed



Accessories

Accessories

Conductor marking

Insert label - PABA WH/23 - 1013779



Insert label, Strip, white, unlabeled, can be labeled with: CMS-P1-PLOTTER, mounting type: thread on, cable diameter range: 1.5 ... 35 mm, lettering field size: 23 x 4 mm, Number of individual labels: 20

Insert label - PABA YE/23 - 1013782



Insert label, Strip, yellow, unlabeled, can be labeled with: CMS-P1-PLOTTER, mounting type: thread on, cable diameter range: 1.5 ... 35 mm, lettering field size: 23 x 4 mm, Number of individual labels: 20

Marker pen

Marker pen - B-STIFT - 1051993



Marker pen, for manual labeling of unprinted Zack strips, smear-proof and waterproof, line thickness 0.5 mm

Plug for cable screw gland

Sensor/actuator cable - SAC-4P-M12MS/ 0,6-PVC/M12FS - 1415612

Accessories

Screw plug - PROT-M12 MS-PA-CHAIN - 1430899

M12 sealing cap with fixing band, for sensor cables, for free M12 sockets



Protective cap

Sealing cap - PROT-M12 FS-PA-CHAIN - 1430873

M12 sealing cap made of plastic with fixing band, for sensor cables, for free M12 plugs



Safety locking

Locking clip - SAC-M12-EXCLIP-M - 1558988



Locking clip for the pin side of sensor/actuator cables with M12 connector and M12 connectors for assembly, for knurl diameter: 15 mm or for Allen key with a wrench size of 14 mm, prevents the disconnection of plug-in connections without tools

Locking clip - SAC-M12-EXCLIP-F - 1558991



Locking clip for the socket side of sensor/actuator cables with M12 connector and M12 connectors for assembly, for knurl diameter: 15 mm or for Allen key with a wrench size of 14 mm, prevents the disconnection of plug-in connections without tools

Screwdriver tools

Sensor/actuator cable - SAC-4P-M12MS/ 0,6-PVC/M12FS - 1415612

Accessories

Adapter insert - TSD-M SAC-BIT ADAPTER - 1212600



Adapter bit for TSD-M...torque tools, E6.3-1/4" drive with 4 mm hexagon to accommodate SAC bits

Tool - SAC BIT M12-D15 - 1208432



Nut for assembling sensor/actuator cables with M12 connector and M12 connectors for assembly, with a knurl diameter of 15 mm, for 4 mm hexagonal drive

Torque tool

Torque screwdriver - TSD 04 SAC - 1208429



Torque screwdriver, with preset torque of 0.4 Nm and 4 mm hexagonal drive for M12 connectors

Torque screwdriver - TSD-M 1,2NM - 1212224



Torque screw driver, accuracy as per EN ISO 6789 standard, adjustable from 0.3 - 1.2 Nm