

Network cable - VS-M12MSS-IP20-94F/20,0/10G



1440656

<https://www.phoenixcontact.com/us/products/1440656>

Please be informed that the data shown in this PDF document is generated from our Online Catalog. Please find the complete data in the user documentation. Our General Terms of Use for Downloads are valid.



Network cable, Ethernet CAT6_A (10 Gbps), 8-position, Plug straight M12 SPEEDCON / IP65, coding: X, on Plug straight RJ45 / IP20, cable length: 20 m

Commercial Data

Item number	1440656
Packing unit	1 pc
Minimum order quantity	1 pc
Sales Key	B06
Product Key	BF1CMJ
Catalog Page	Page 304 (PC-2011)
GTIN	4046356504577
Weight per Piece (including packing)	937.8 g
Weight per Piece (excluding packing)	800 g
Customs tariff number	85444290
Country of origin	PL

Network cable - VS-M12MSS-IP20-94F/20,0/10G



1440656

<https://www.phoenixcontact.com/us/products/1440656>

Technical Data

Product properties

Product type	Data cable preassembled
Number of positions	8
Application	Standard
Number of slots	1
Shielded	yes
Coding	X - data

Insulation characteristics

Overvoltage category	I
Degree of pollution	1

Interfaces

Signal type/category	Ethernet CAT6 _A , 10 Gbps
----------------------	--------------------------------------

Electrical properties

Nominal voltage U_N	48 V AC
	60 V DC
Nominal current I_N	0.5 A
Transmission medium	Copper

Connector

Insertion/withdrawal cycles	≥ 100
-----------------------------	------------

Connection 1

Type	Plug straight M12 SPEEDCON / IP65
Number of positions	8 (8)
Coding type	X (Data)
Shielded	yes
Handle color	black
Degree of protection	IP65
	IP67
	IP69K

Connection 2

Type	Plug straight RJ45 / IP20
Number of positions	8 (8)
Shielded	yes
Handle color	gray

Cable / line

Cable length	20 m
Cable weight	42 kg/km

Network cable - VS-M12MSS-IP20-94F/20,0/10G



1440656

<https://www.phoenixcontact.com/us/products/1440656>

UL AWM Style	20963 (80°C/30 V)
Number of positions	8
Shielded	yes
Cable type	Ethernet 10 Gbit [94F]
Signal runtime	5.13 ns/m
Conductor structure signal line	7x 0.16 mm
AWG signal line	26
Conductor cross section	4x 2x 0.14 mm ²
Wire diameter incl. insulation	1.04 mm
External cable diameter	6.4 mm ±0.2 mm
Outer sheath, material	PUR
External sheath, color	water blue RAL 5021
Conductor material	Bare Cu litz wires
Material wire insulation	Foamed PE
Single wire, color	white/blue-blue, white/orange-orange, white/green-green, white/brown-brown
Thickness, outer sheath	0.65 mm
Twisted pairs	2 cores to the pair
Type of pair shielding	Aluminum-lined foil
Overall twist	4 pairs for core
Optical shield covering	70 %
Insulation resistance	≥ 500 MΩ*km
Loop resistance	≤ 290.00 Ω/km
Wave impedance	100 Ω ±5 Ω (at 100 MHz)
Cable capacity	47 nF/km
Nominal voltage, cable	≤ 100 V
Test voltage Core/Core	700 V (50 Hz, 1 min.)
Test voltage Core/Shield	700 V (50 Hz, 1 min.)
Minimum bending radius, fixed installation	4 x D
Minimum bending radius, flexible installation	8 x D
Tensile strength	≤ 100 N
Near end crosstalk attenuation (NEXT)	75.3 dB (with 1 MHz) 66.3 dB (at 4 MHz) 61.8 dB (at 8 MHz) 60.3 dB (at 10 MHz) 57.2 dB (at 16 MHz) 55.8 dB (at 20 MHz) 54.3 dB (at 25 MHz) 52.8 dB (at 31.25 MHz) 48.4 dB (at 62.5 MHz) 45.3 dB (at 100 MHz) 40.8 dB (at 200 MHz) 39.3 dB (at 250 MHz) 38.1 dB (at 300 MHz)

Network cable - VS-M12MSS-IP20-94F/20,0/10G



1440656

<https://www.phoenixcontact.com/us/products/1440656>

	36.3 dB (at 400 MHz)
	34.8 dB (at 500 MHz)
Power-summated near end crosstalk attenuation (PSNEXT)	72.3 dB (with 1 MHz)
	63.3 dB (at 4 MHz)
	58.8 dB (at 8 MHz)
	57.3 dB (at 10 MHz)
	54.2 dB (at 16 MHz)
	52.8 dB (at 20 MHz)
	51.3 dB (at 25 MHz)
	49.9 dB (at 31.25 MHz)
	45.4 dB (at 62.5 MHz)
	42.3 dB (at 100 MHz)
	37.8 dB (at 200 MHz)
	36.3 dB (at 250 MHz)
	35.1 dB (at 300 MHz)
	33.3 dB (at 400 MHz)
31.8 dB (at 500 MHz)	
Return loss (RL)	20 dB (with 1 MHz)
	23 dB (at 4 MHz)
	24.5 dB (at 8 MHz)
	25 dB (at 10 MHz)
	25 dB (at 16 MHz)
	25 dB (at 20 MHz)
	24.2 dB (at 25 MHz)
	23.3 dB (at 31.25 MHz)
	20.7 dB (at 62.5 MHz)
	19 dB (at 100 MHz)
	16.4 dB (at 200 MHz)
	15.6 dB (at 250 MHz)
	15.6 dB (at 300 MHz)
	15.6 dB (at 400 MHz)
15.6 dB (at 500 MHz)	
Shield attenuation	3.1 dB (with 1 MHz)
	5.7 dB (at 4 MHz)
	8 dB (at 8 MHz)
	8.9 dB (at 10 MHz)
	11.2 dB (at 16 MHz)
	12.6 dB (at 20 MHz)
	14.1 dB (at 25 MHz)
	15.8 dB (at 31.25 MHz)
	22.5 dB (at 62.5 MHz)
	28.7 dB (at 100 MHz)
	41.4 dB (at 200 MHz)
	46.6 dB (at 250 MHz)

Network cable - VS-M12MSS-IP20-94F/20,0/10G



1440656

<https://www.phoenixcontact.com/us/products/1440656>

	51.4 dB (at 300 MHz)
	60.1 dB (at 400 MHz)
	67.9 dB (at 500 MHz)
	≥ 80 dB (at 30 ... 100 MHz)
Halogen-free	according to IEC 60754-1
Flame resistance	according to IEC 60332-1-2
Resistance to oil	in accordance with DIN EN 60811-2-1
Ambient temperature (operation)	-40 °C ... 80 °C (cable, fixed installation) -20 °C ... 80 °C (Cable, flexible installation)
Ambient temperature (installation)	-20 °C ... 80 °C
Signal type/category	Ethernet CAT6 _A , 10 Gbps

Ambient conditions

Degree of protection	IP65 (M12 connector) IP67 (M12 connector) IP20 (RJ45 connector)
Degree of protection	IP67/IP20
Ambient temperature (operation)	-20 °C ... 60 °C

Network cable - VS-M12MSS-IP20-94F/20,0/10G



1440656

<https://www.phoenixcontact.com/us/products/1440656>

Drawings

Dimensional drawing

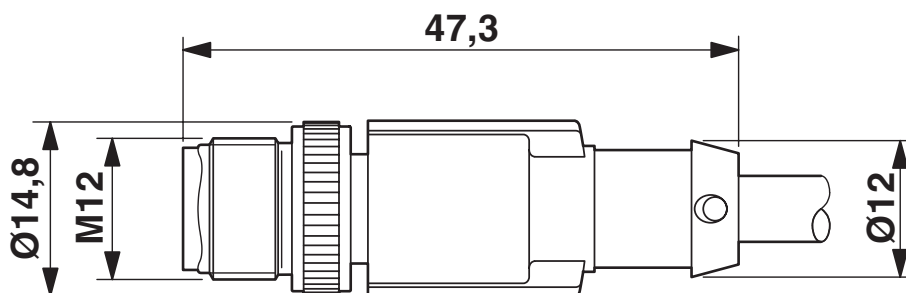

M12 connector dimensional drawing

Network cable - VS-M12MSS-IP20-94F/20,0/10G

1440656

<https://www.phoenixcontact.com/us/products/1440656>

Schematic diagram



Connector pin assignment plug RJ45

Network cable - VS-M12MSS-IP20-94F/20,0/10G



1440656

<https://www.phoenixcontact.com/us/products/1440656>

Dimensional drawing

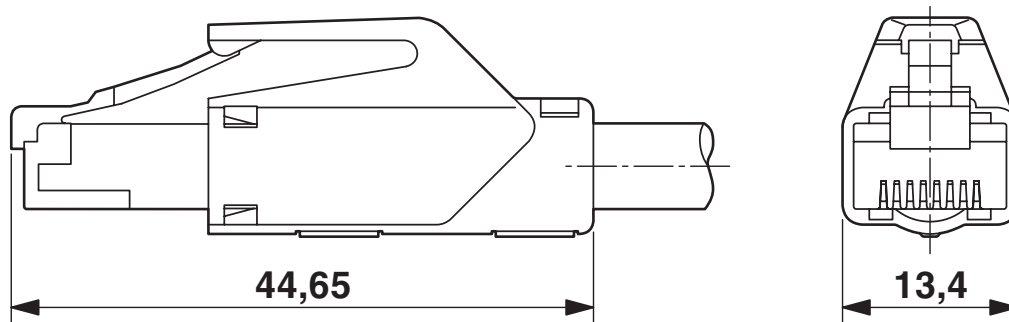

RJ45 connector dimensional drawing

Circuit diagram

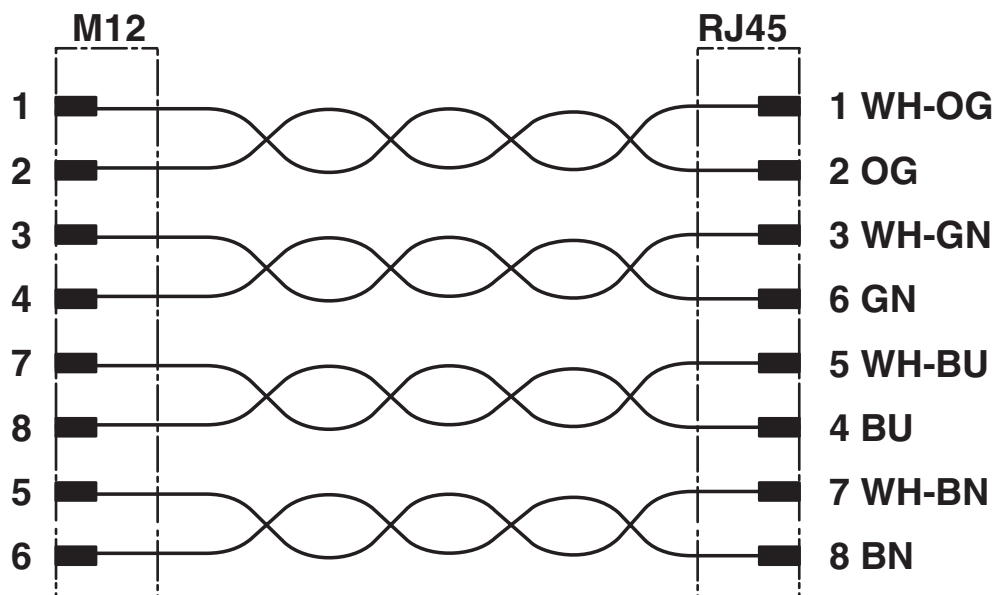

1440656

<https://www.phoenixcontact.com/us/products/1440656>

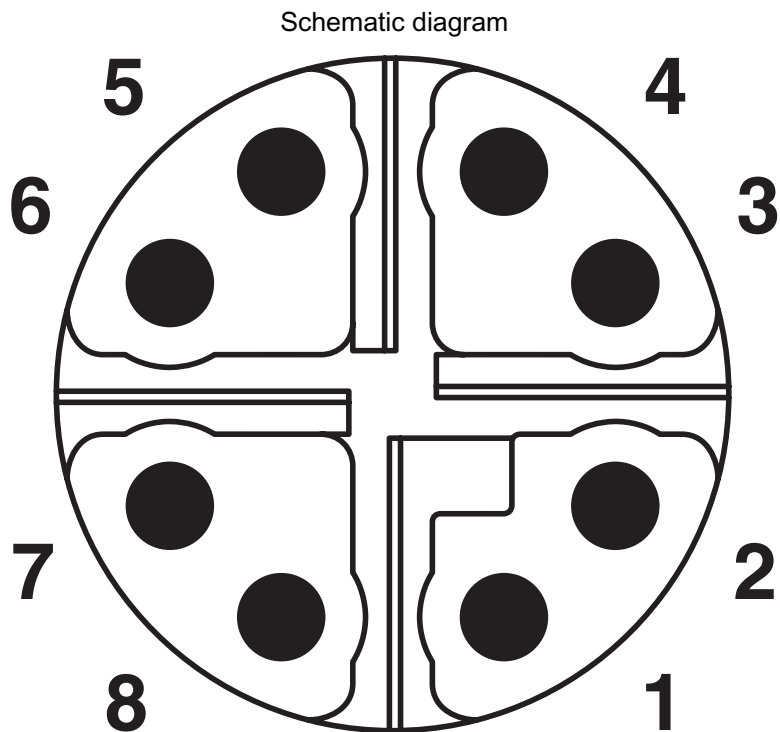

M12 Cat6_A, 8-pos. plug pin assignment, pin side view

Network cable - VS-M12MSS-IP20-94F/20,0/10G





1440656

<https://www.phoenixcontact.com/us/products/1440656>

Approvals

 UL Listed Approval ID: FILE E 335024				
	Nominal Voltage U_N	Nominal Current I_N	Cross Section AWG	Cross Section mm^2
	30 V	0.5 A	-	-

 cUL Listed Approval ID: FILE E 335024				
	Nominal Voltage U_N	Nominal Current I_N	Cross Section AWG	Cross Section mm^2
	30 V	0.5 A	-	-

 EAC Approval ID: RU D-DE.HB35.B.00385	
---	--

cULus Listed

Network cable - VS-M12MSS-IP20-94F/20,0/10G



1440656

<https://www.phoenixcontact.com/us/products/1440656>

Classifications

ECLASS

ECLASS-9.0	27060308
ECLASS-10.0.1	27060308
ECLASS-11.0	27060307

ETIM

ETIM 8.0	EC001855
----------	----------

UNSPSC

UNSPSC 21.0	26121600
-------------	----------

Network cable - VS-M12MSS-IP20-94F/20,0/10G



1440656

<https://www.phoenixcontact.com/us/products/1440656>

Environmental Product Compliance

REACH SVHC	Lead 7439-92-1
China RoHS	Environmentally Friendly Use Period = 50 years
	For information on hazardous substances, refer to the manufacturer's declaration available under "Downloads"

Phoenix Contact 2022 © - all rights reserved
<https://www.phoenixcontact.com>

Phoenix Contact USA
586 Fulling Mill Road
Middletown, PA 17057, United States
(+717) 944-1300
info@phoenixcon.com