

Bus system cable - SAC-3P-M12MR/ 2,0-961/M12FS VA



1419113

<https://www.phoenixcontact.com/pc/products/1419113>

Please be informed that the data shown in this PDF document is generated from our Online Catalog. Please find the complete data in the user documentation. Our General Terms of Use for Downloads are valid.



Bus system cable, PROFIBUS PA (31.25 kbps), 3-position, PVC, blue RAL 5015, shielded, Plug angled M12, coding: A, on Socket straight M12, coding: A, cable length: 2 m, For Ex area with high-grade steel knurl

Commercial Data

Item number	1419113
Packing unit	1 pc
Minimum order quantity	1 pc
Product Key	BF1CCG
Catalog Page	Page 430 (C-2-2019)
GTIN	4046356541800
Weight per Piece (including packing)	222.22 g
Weight per Piece (excluding packing)	222.22 g
Customs tariff number	85444290
Country of origin	PL

Bus system cable - SAC-3P-M12MR/ 2,0-961/M12FS VA



1419113

<https://www.phoenixcontact.com/pc/products/1419113>

Technical Data

Notes

General	For applications in circuits of intrinsic safety protection type "i". Electrical values following EN 60079-14.
---------	---

Product properties

Product type	Data cable preassembled
Number of positions	3
Application	Process technology
No. of cable outlets	1
Shielded	yes
Coding	B - inverse

Insulation characteristics

Overvoltage category	II
Degree of pollution	3

Interfaces

Bus system	PROFIBUS PA
Signal type/category	PROFIBUS PA, 31.25 kbps

LED signaling

Status display	No
Status display present	No

Electrical properties

Contact resistance	≤ 5 mΩ
Nominal voltage U_N	48 V AC
	60 V DC
Nominal current I_N	4 A
Transmission medium	Copper

Mechanical properties

Mechanical data

Insertion/withdrawal cycles	≥ 100
-----------------------------	-------

Material specifications

Color Handle area	black
Flammability rating according to UL 94	HB
Sealing material	NBR
Material of grip body	TPU, hardly inflammable, self-extinguishing
Contact material	CuSn
Contact surface material	Ni/Au

Bus system cable - SAC-3P-M12MR/ 2,0-961/M12FS VA



1419113

<https://www.phoenixcontact.com/pc/products/1419113>

Contact carrier material	TPU GF
Material for screw connection	Stainless steel

Connection data

Pin assignment

Contact Color (signal designation) Contact (optional)	1 (Plug) = OG (DATA+) = 1 (Socket)
	3 (Plug) = BU (DATA-) = 3 (Socket)
	4 (Plug) = SR (shield) = 4 (Socket)

Connector

Connection 1

Head design	Plug
Head cable outlet	angled
Head thread type	M12
Coding	A

Connection 2

Head design	Socket
Head cable outlet	straight
Head thread type	M12
Coding	A

Cable / line

Cable length	2 m
--------------	-----

Fieldbus FOUNDATION/PROFIBUS PA, blue [961]

Dimensional drawing	
Cable weight	56.552 kg/km
Number of positions	2
Shielded	yes
Cable type	Fieldbus FOUNDATION/PROFIBUS PA, blue [961]
Conductor structure	2xAWG18/7 + 1xAWG20/7
Signal speed	0.66 c
Conductor structure signal line	7x 0.40 mm
AWG signal line	18
Conductor cross section	2x 0.75 mm ² (Signal line) 1x 0.5 mm ² (Drain wire)

Bus system cable - SAC-3P-M12MR/ 2,0-961/M12FS VA



1419113

<https://www.phoenixcontact.com/pc/products/1419113>

Wire diameter incl. insulation	2.24 mm ±0.05 mm
External cable diameter	7.5 mm ±0.25 mm
Outer sheath, material	PVC
External sheath, color	blue RAL 5015
Conductor material	Tin-plated Cu litz wires
Material wire insulation	PO (Signal line)
Single wire, color	Blue, orange
Thickness, insulation	0.5 mm
Thickness, outer sheath	1 mm
Twisted pairs	2 cores to the pair
Overall twist	One pair with one drain wire and fillers for core
Optical shield covering	100 %
Max. conductor resistance	≤ 19.35 Ω/km (Signal line) 26 Ω/km (shield)
Cable capacity	147 pF/m (at 1 kHz, core/shield) ≤ 3.94 pF/m (capacitance unbalance)
Working capacitance	78 nF (at 1 kHz)
Cable impedance	100 Ω ±20 % (At 31.25 kHz)
Nominal voltage, cable	300 V
Smallest bending radius, fixed installation	75 mm
Tensile strength	260 N
Shield attenuation	3 dB/km (at 39 kHz)
Flame resistance	UL 1685 (CSA FT 4) UL 1685 (vertical tray) UL 1666 (riser)
Special properties	UL standards PLTC-ER and ITC
Ambient temperature (operation)	-40 °C ... 105 °C (cable, fixed installation)

Ambient conditions

Degree of protection	IP65
	IP67
	IP68
	IP69K
Ambient temperature (operation)	-25 °C ... 90 °C (Plug / socket)

Bus system cable - SAC-3P-M12MR/ 2,0-961/M12FS VA

1419113

<https://www.phoenixcontact.com/pc/products/1419113>

Drawings

Schematic diagram

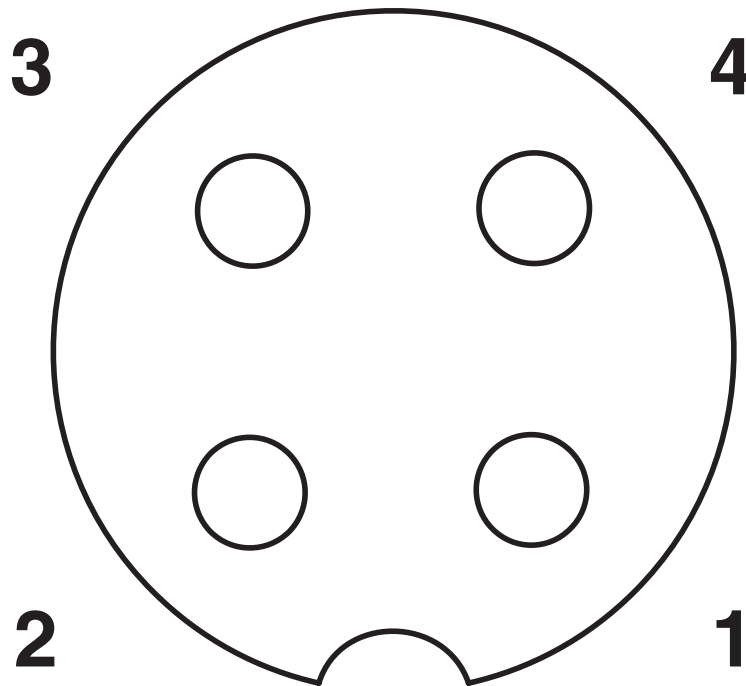

Pin assignment M12 socket, 3-pos., A-coded, view female side

Dimensional drawing

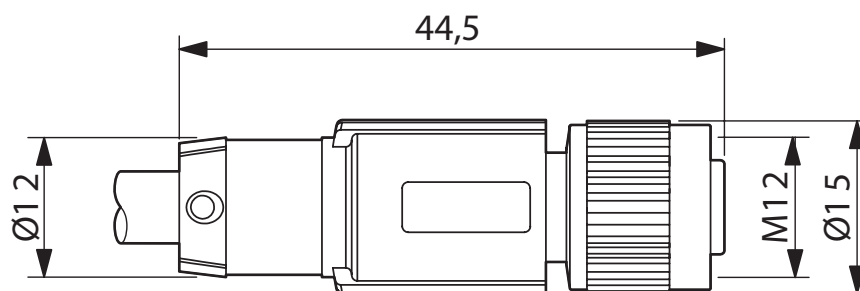

M12 x 1 socket, straight

Bus system cable - SAC-3P-M12MR/ 2,0-961/M12FS VA



1419113

<https://www.phoenixcontact.com/pc/products/1419113>

Circuit diagram

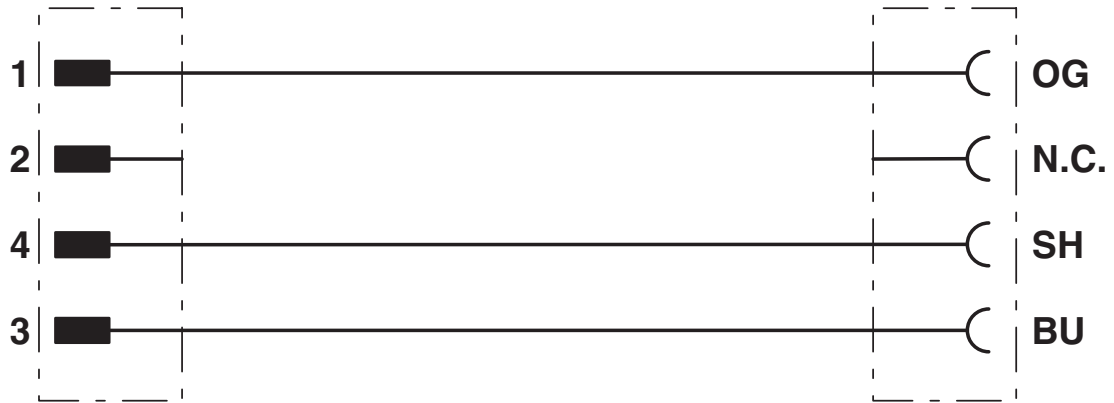

Schematic diagram

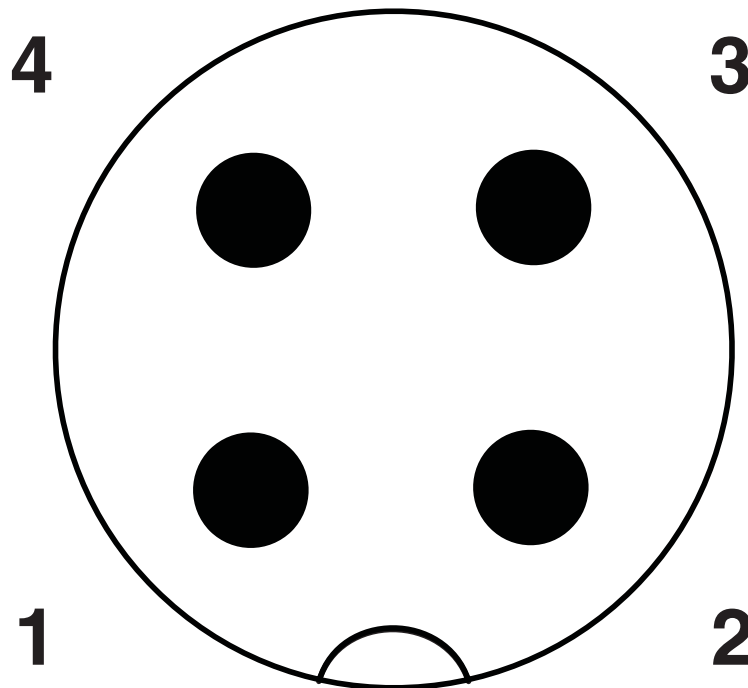

Pin assignment M12 plug, 3-pos., A-coded, view male side

Bus system cable - SAC-3P-M12MR/ 2,0-961/M12FS VA

1419113

<https://www.phoenixcontact.com/pc/products/1419113>

Dimensional drawing

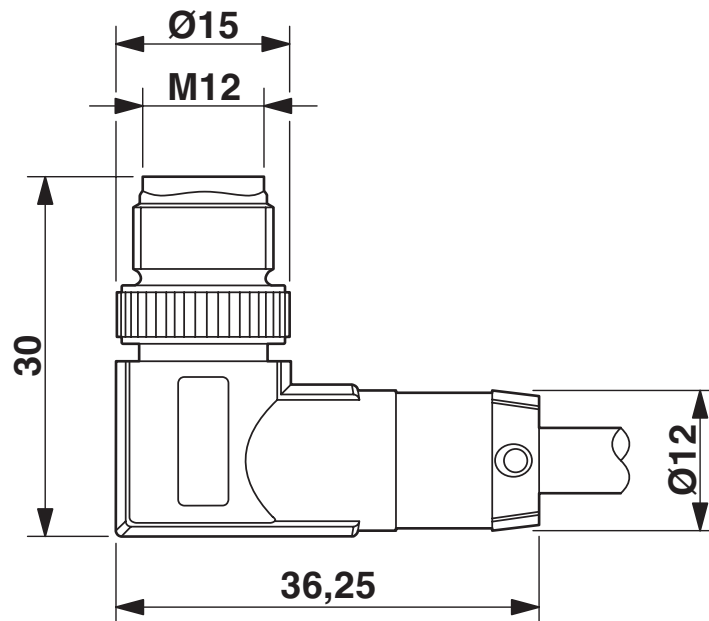

M12 x 1 male plug, angled

Bus system cable - SAC-3P-M12MR/ 2,0-961/M12FS VA



1419113

<https://www.phoenixcontact.com/pc/products/1419113>

Approvals



EAC

Approval ID: RU C-DE.BL08.B.00286



EAC

Approval ID: RU D-DE.HB35.B.00387

Bus system cable - SAC-3P-M12MR/ 2,0-961/M12FS VA



1419113

<https://www.phoenixcontact.com/pc/products/1419113>

Classifications

ECLASS

ECLASS-9.0	27060308
ECLASS-10.0.1	27060308
ECLASS-11.0	27060307

ETIM

ETIM 8.0	EC001855
----------	----------

UNSPSC

UNSPSC 21.0	26121600
-------------	----------

Bus system cable - SAC-3P-M12MR/ 2,0-961/M12FS VA



1419113

<https://www.phoenixcontact.com/pc/products/1419113>

Environmental Product Compliance

China RoHS	Environmentally friendly use period: unlimited = EFUP-e
	No hazardous substances above threshold values

Bus system cable - SAC-3P-M12MR/ 2,0-961/M12FS VA



1419113

<https://www.phoenixcontact.com/pc/products/1419113>

Accessories

Torque screwdriver

Torque screwdriver - TSD 04 SAC - 1208429

<https://www.phoenixcontact.com/pc/products/1208429>



Torque screwdriver, with preset torque of 0.4 Nm and 4 mm hexagonal drive for M12 connectors

Torque screwdriver

Torque screwdriver - TSD-M 1,2NM - 1212224

<https://www.phoenixcontact.com/pc/products/1212224>



Torque screw driver, accuracy as per EN ISO 6789 standard, adjustable from 0.3 - 1.2 Nm

Bus system cable - SAC-3P-M12MR/ 2,0-961/M12FS VA



1419113

<https://www.phoenixcontact.com/pc/products/1419113>

Adapter insert

Adapter insert - TSD-M SAC-BIT ADAPTER - 1212600

<https://www.phoenixcontact.com/pc/products/1212600>



Adapter bit for TSD-M...torque tools, E6.3-1/4" drive with 4 mm hexagon to accommodate SAC bits

Tool

Tool - SAC BIT M12-W14 - 1212513

<https://www.phoenixcontact.com/pc/products/1212513>



Nut for assembling sensor/actuator cables with M12 connector and M12 connectors for assembly, with a hexagonal knurl wrench size of 14 mm, with 4 mm hexagonal drive

Phoenix Contact 2022 © - all rights reserved
<https://www.phoenixcontact.com>

PHOENIX CONTACT GmbH & Co. KG
Flachsmarktstraße 8
D-32825 Blomberg
+49 (0) 5235-3 00
info@phoenixcontact.com