

Connector - SACC-M12FS-5CON-PG11 SH



1417877

<https://www.phoenixcontact.com/in/products/1417877>

Please be informed that the data shown in this PDF document is generated from our Online Catalog. Please find the complete data in the user documentation. Our General Terms of Use for Downloads are valid.



Connector, 5-position, shielded, Socket straight M12, Coding: A, Screw connection, knurl material: Zinc die-cast, nickel-plated, cable gland Pg11, external cable diameter 8 mm ... 10 mm

Your advantages

- Safe use in the field, thanks to a high degree of protection
- Screw connection: proven connection technology for a large selection of different conductors
- Reliable signal transmission - 360° shielding in environments with electromagnetic interference

Connector - SACC-M12FS-5CON-PG11 SH



1417877

<https://www.phoenixcontact.com/in/products/1417877>

Commercial Data

Item number	1417877
Packing unit	1 pc
Minimum order quantity	1 pc
Sales Key	BF2
Product Key	BF2CBA
GTIN	4055626129303
Weight per Piece (including packing)	57.63 g
Weight per Piece (excluding packing)	57.63 g
Customs tariff number	85366990
Country of origin	DE

Technical Data

Notes

Assembly instruction:

NOTE: Observe the permissible bending radii when laying conductors, since the degree of protection may be put in jeopardy if the bending forces are too high. Alleviate mechanical loads upstream of the connector, e.g. by using cable ties.

Product properties

Product type	Circular connector (cable-side)
Number of positions	5
No. of cable outlets	1
Shielded	yes
Coding	A - standard
Cable outlet	straight
Pg screw connection	Pg11

Insulation characteristics

Overvoltage category	II
Degree of pollution	3

Ambient conditions

Degree of protection	IP67
Ambient temperature (operation)	-40 °C ... 85 °C (Plug / socket)

Dimensions

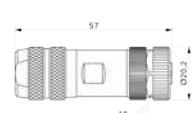
Dimensional drawing	
Length	57 mm

External dimensions

Outside diameter	8 mm ... 10 mm
------------------	----------------

Housing

Diameter housing	20.2 mm
------------------	---------

Connector

Insertion/withdrawal cycles	≥ 100
-----------------------------	-------

Header 1

Head design	Socket
Head cable outlet	straight
Head thread type	M12

Connector - SACC-M12FS-5CON-PG11 SH



1417877

<https://www.phoenixcontact.com/in/products/1417877>

Coding	A-coded
--------	---------

Electrical properties

Rated surge voltage	1.5 kV
Contact resistance	$\leq 3 \text{ m}\Omega$
Insulation resistance	$\geq 100 \text{ M}\Omega$
Nominal voltage U_N	48 V AC
	60 V DC
Nominal current I_N	4 A

Material specifications

Flammability rating according to UL 94	HB
Sealing material	NBR
Material of grip body	Zinc die-cast, nickel-plated
Contact material	CuZn
Contact surface material	Au
Contact carrier material	PA
Cable gland material	Zinc die-cast, nickel-plated

Connection data

Conductor connection

Connection method	Screw connection
Connection cross section	0.25 mm ² ... 0.75 mm ² (without ferrule)
	0.25 mm ² ... 0.75 mm ² (without ferrule)
	0.25 mm ² ... 0.75 mm ² (without ferrule)
Connection cross section AWG	24 ... 18 (without ferrule)
	26 ... 20 (with ferrule)
Tightening torque	0.4 Nm (M12 knurl)
	0.2 Nm (Screw terminal blocks)
	1 Nm ... 1.4 Nm (Pressure nut with 8 mm ... 12 mm external cable diameter)

Standards and regulations

Standards/specifications	IEC 61076-2-101
--------------------------	-----------------

Cable / line

Cable structure

Stripping length of the individual wire	5 mm
---	------

1417877

<https://www.phoenixcontact.com/in/products/1417877>

Drawings

Schematic diagram

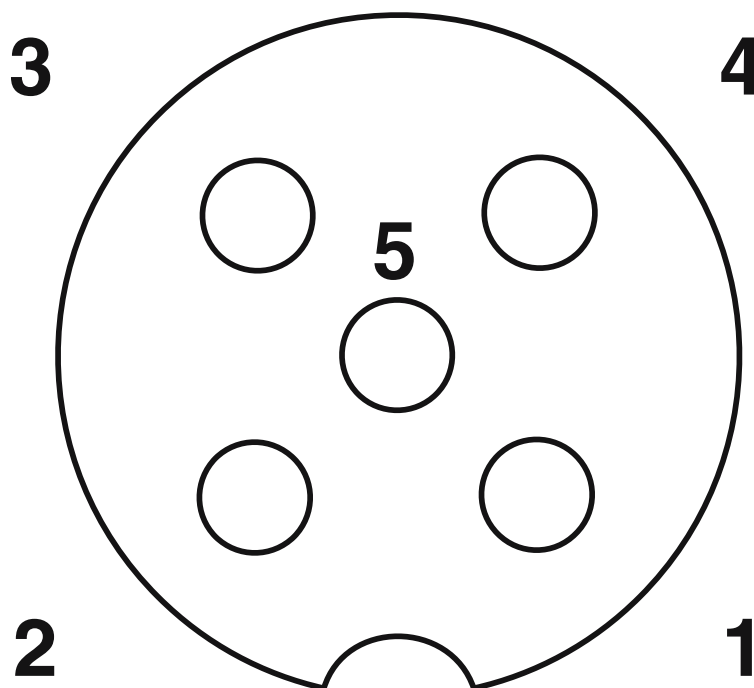

Pin assignment M12 socket, 5-pos., A-coded, socket side view

Functional drawing

Assembly steps for M 12 male/female connector and conductor

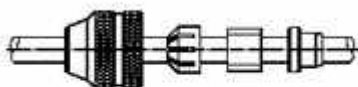

Slide parts onto the conductor

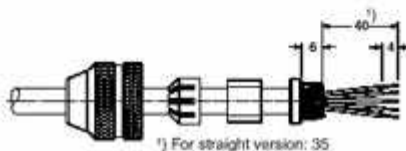

Strip conductor, widen shield and lay around the shielding ring, cut off projecting mesh.

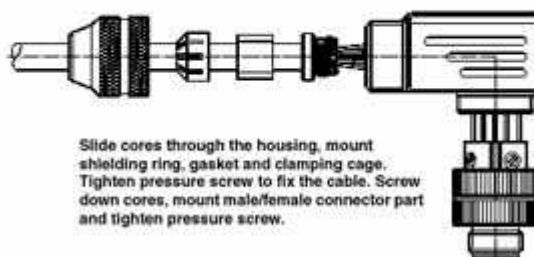

Slide cores through the housing, mount shielding ring, gasket and clamping cage. Tighten pressure screw to fix the cable. Screw down cores, mount male/female connector part and tighten pressure screw.

Connector - SACC-M12FS-5CON-PG11 SH

1417877

<https://www.phoenixcontact.com/in/products/1417877>

Dimensional drawing

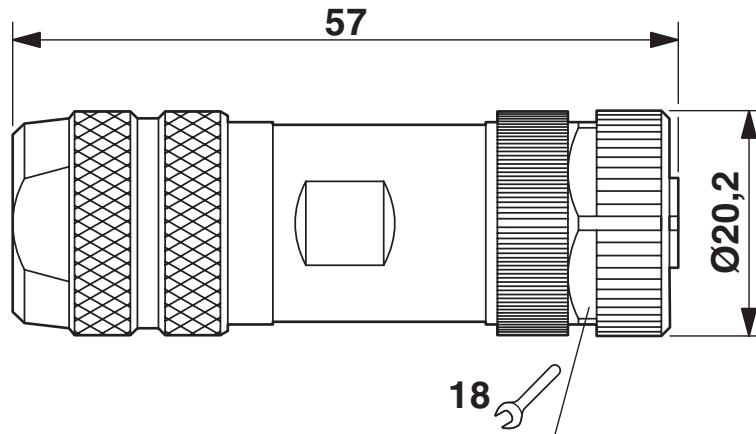

M12 x 1 socket, straight, shielded

Schematic diagram

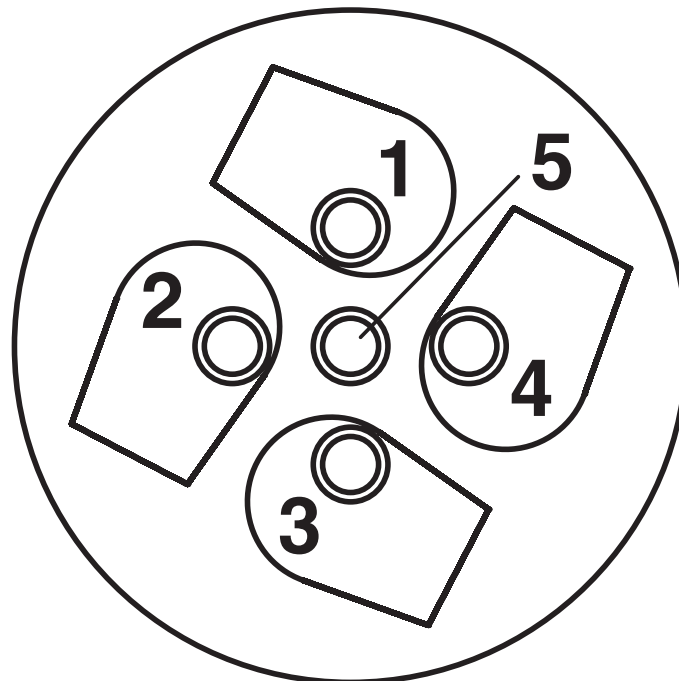

Cable connection side M12 (screw connection)

Connector - SACC-M12FS-5CON-PG11 SH



1417877

<https://www.phoenixcontact.com/in/products/1417877>

Classifications

ECLASS

ECLASS-9.0	27440102
ECLASS-10.0.1	27440102
ECLASS-11.0	27440102

ETIM

ETIM 8.0	EC002635
----------	----------

UNSPSC

UNSPSC 21.0	39121400
-------------	----------

Connector - SACC-M12FS-5CON-PG11 SH



1417877

<https://www.phoenixcontact.com/in/products/1417877>

Environmental Product Compliance

REACH SVHC	Lead 7439-92-1
China RoHS	Environmentally Friendly Use Period = 50 years
	For information on hazardous substances, refer to the manufacturer's declaration available under "Downloads"

Connector - SACC-M12FS-5CON-PG11 SH

1417877

<https://www.phoenixcontact.com/in/products/1417877>

Accessories

Torque screwdriver

Torque screwdriver - TSD 04 SAC - 1208429

<https://www.phoenixcontact.com/in/products/1208429>



Torque screwdriver, with preset torque of 0.4 Nm and 4 mm hexagonal drive for M12 connectors

Tool

Tool - SACC BIT M12-D20 - 1208445

<https://www.phoenixcontact.com/in/products/1208445>



Nut for assembling M12 connectors for assembly with a knurl diameter of 20 mm, for 4 mm hexagonal drive

Connector - SACC-M12FS-5CON-PG11 SH



1417877

<https://www.phoenixcontact.com/in/products/1417877>

Torque screwdriver

Torque screwdriver - TSD-M 1,2NM - 1212224

<https://www.phoenixcontact.com/in/products/1212224>



Torque screw driver, accuracy as per EN ISO 6789 standard, adjustable from 0.3 - 1.2 Nm

Adapter insert

Adapter insert - TSD-M SAC-BIT ADAPTER - 1212600

<https://www.phoenixcontact.com/in/products/1212600>



Adapter bit for TSD-M...torque tools, E6.3-1/4" drive with 4 mm hexagon to accommodate SAC bits

Connector - SACC-M12FS-5CON-PG11 SH



1417877

<https://www.phoenixcontact.com/in/products/1417877>

Screw plug

Screw plug - PROT-M12 MS-PA-CHAIN - 1430899

<https://www.phoenixcontact.com/in/products/1430899>

M12 sealing cap with fixing band, for sensor cables, for free M12 sockets



Ferrule

Ferrule - A 0,25- 5 - 3202465

<https://www.phoenixcontact.com/in/products/3202465>

Ferrule, length: 5 mm, color: silver



Connector - SACC-M12FS-5CON-PG11 SH



1417877

<https://www.phoenixcontact.com/in/products/1417877>

Crimping pliers

Crimping pliers - CRIMPFOX 6H - 1212046

<https://www.phoenixcontact.com/in/products/1212046>



Crimping pliers, for ferrules without insulating collar according to DIN 46228 Part 1 and ferrules with insulating collar according to DIN 46228 Part 4, 0.14 mm² ... 6 mm², unlockable pressure lock, lateral entry

Stripping tool

Stripping tool - VS-CABLE-STRIP-VARIO - 1657407

<https://www.phoenixcontact.com/in/products/1657407>

Stripping tool, for the multi-level stripping of shielded cables



Connector - SACC-M12FS-5CON-PG11 SH



1417877

<https://www.phoenixcontact.com/in/products/1417877>

Screwdriver

Screwdriver - SZF 1-0,6X3,5 - 1204517

<https://www.phoenixcontact.com/in/products/1204517>



Actuation tool, for ST terminal blocks, also suitable for use as a bladed screwdriver, size: 0.6 x 3.5 x 100 mm, 2-component grip, with non-slip grip

Phoenix Contact 2022 © - all rights reserved

<https://www.phoenixcontact.com>

PHOENIX CONTACT (I) Pvt. Ltd.

A-58/2, Okhla Industrial Area, Phase - II, New Delhi-110 020

+91.1275.71420

info@phoenixcontact.co.in