

Flush-type connector - SACC-CI-M8FS-4P SMD R32 - 1412244

Please be informed that the data shown in this PDF Document is generated from our Online Catalog. Please find the complete data in the user's documentation. Our General Terms of Use for Downloads are valid (<http://phoenixcontact.com/download>)



Flush-type connector, 4-position, Socket, straight, M8, A-coded, PCB mounting, SMD

Why buy this product

- Reduced mounting costs thanks to two-piece device connector
- Packaging available for automated pick and place assembly
- All common pin assignments and codings available
- Easy device integration thanks to mechanical port screw connections with threaded attachment, press-in contour or direct integration in the front plate
- Optional shield connection and seal for the device when not plugged in

Key Commercial Data

Packing unit	100 STK
Minimum order quantity	100 STK
GTIN	 4 046356 988858
GTIN	4046356988858

Technical data

Ambient conditions

Ambient temperature (operation)	-55 °C ... 105 °C (Plug / socket)
	-55 °C ... 105 °C (without mechanical actuation)
Degree of protection	IP67 (correctly plugged in and locked)

General

Note	The electrical and mechanical data specified assume that the connector pair is correctly locked and mounted. If the connector is unlocked and if there is a danger of contamination, the connector must be sealed using a protective cap > IP54. Influences arising from litz wires, cables or PCB assembly must also be taken into consideration.
Rated current at 40°C	3 A
Rated voltage	50 V AC

Flush-type connector - SACC-CI-M8FS-4P SMD R32 - 1412244

Technical data

General

	60 V DC
Number of positions	4
Insulation resistance	≥ 100 MΩ
Coding	A - standard
Standards/regulations	M8 connector IEC 61076-2-104
Overvoltage category	II
Connection method	SMD
Insertion/withdrawal cycles	> 100
Mounting type	PCB mounting
Type of packaging	Belt

Material

Flammability rating according to UL 94	V0
Contact material	CuZn
Contact surface material	Au
Contact carrier material	PA

Cable

Standards/specifications	M8 connector IEC 61076-2-104
--------------------------	------------------------------

Standards and Regulations

Standard designation	M8 connector
Standards/regulations	IEC 61076-2-104
Flammability rating according to UL 94	V0

Environmental Product Compliance

REACH SVHC	Lead 7439-92-1
China RoHS	Environmentally Friendly Use Period = 50
	For details about hazardous substances go to tab "Downloads", Category "Manufacturer's declaration"

Drawings

Flush-type connector - SACC-CI-M8FS-4P SMD R32 - 1412244

Schematic diagram

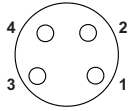

Pin assignment M8 socket, 4-pos., view female side

Drilling diagram

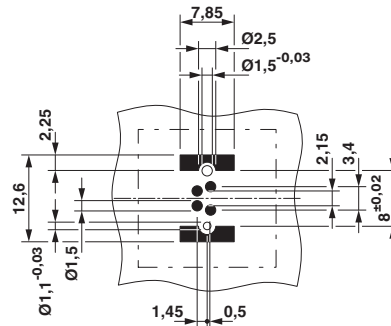

Drilling diagram

Dimensional drawing

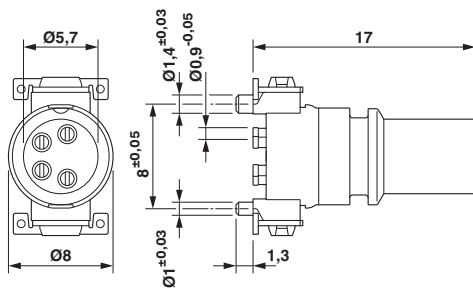

M8 flush-type socket

Dimensional drawing

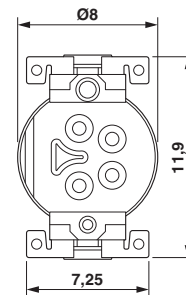

View of solder side

Dimensional drawing

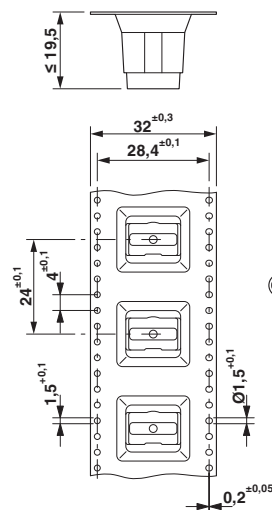

SMD tape-on-reel packing

Flush-type connector - SACC-CI-M8FS-4P SMD R32 - 1412244

Approvals

Approvals

Approvals

EAC / cULus Recognized

Ex Approvals

Approval details

EAC		B.01742
-----	---	---------

cULus Recognized		http://database.ul.com/cgi-bin/XYV/template/LISEXT/1FRAME/index.htm	E221474-20160506
Nominal voltage UN		30 V	
Nominal current IN		3 A	

Phoenix Contact 2018 © - all rights reserved
<http://www.phoenixcontact.com>

PHOENIX CONTACT GmbH & Co. KG
Flachsmarktstr. 8
32825 Blomberg
Germany
Tel. +49 5235 300
Fax +49 5235 3 41200
<http://www.phoenixcontact.com>