

130519 ✓ ACTIVE

SOLISTRAND

TE Internal #: 130519

Spade Tongue Terminal, 22 – 16 AWG, M4 Stud Size, 4.3 mm [.169 in] Stud Diameter, Closed Barrel, Straight, Tin, Uninsulated

[View on TE.com >](#)



Terminals & Splices > Spade Terminals

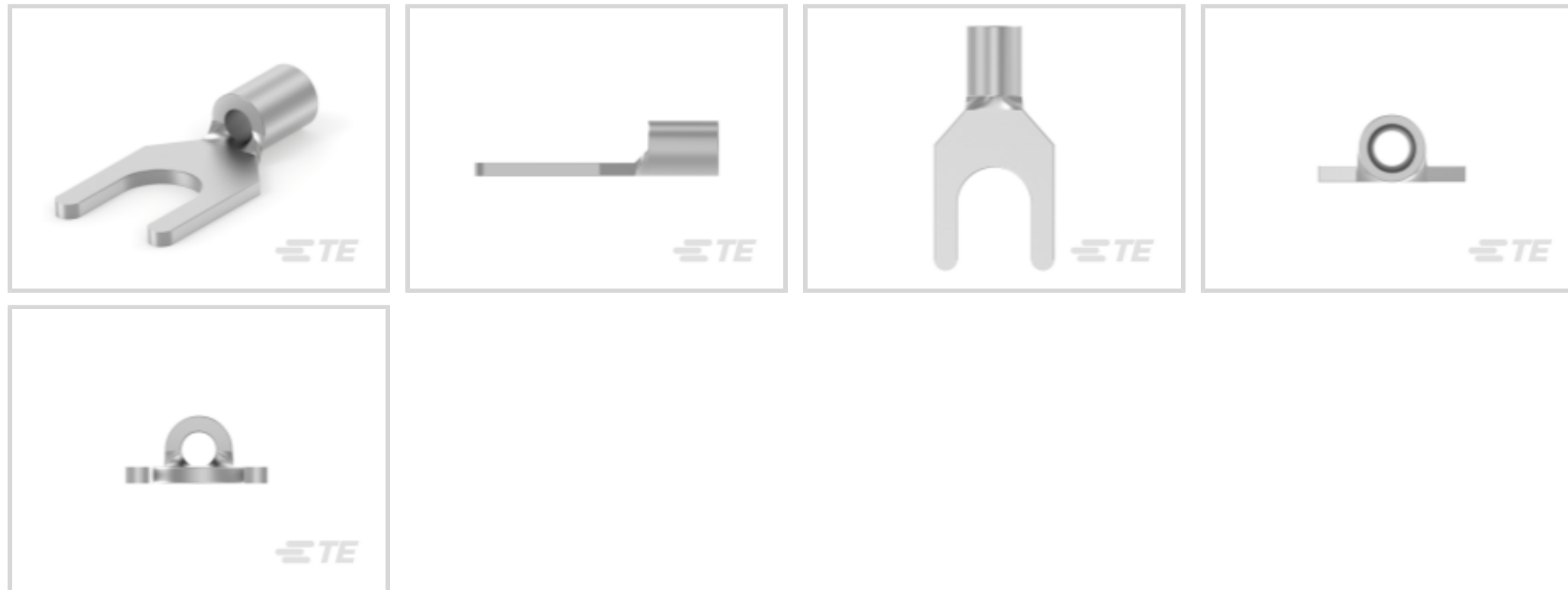

Spade Terminal Type: **Spade Tongue Terminal**

Wire Size: **509 – 3260 CMA**

Stud Size: **M4**

### Features

#### Product Type Features

Stud Size	M4
Sealable	No
Wire Insulation Support Retention Type	Non-Insulation Support

#### Contact Features

Spade Terminal Type	Spade Tongue Terminal
Barrel Type	Closed
Terminal Orientation	Straight
Terminal Plating Material	Tin

#### Mechanical Attachment

Wire Insulation Support	Without
-------------------------	---------

#### Dimensions

Wire Size	509 – 3260 CMA
Stud Diameter	4.3 mm [.169 in]
Tongue Thickness	.79 mm [.031 in]
Product Length	14.98 mm [.59 in]
Barrel Inside Diameter	1.55 mm [.061 in]



### Usage Conditions

Insulation Option	Uninsulated
Operating Temperature Range	170 °C[338 °F]

### Operation/Application

Compatible With Wire Base Material	Copper
Compatible With Wire Plating Material	Tin

### Industry Standards

Government Qualified Terminal	No
-------------------------------	----

### Packaging Features

Packaging Quantity	1000
Packaging Method	Box

### Product Compliance

[For compliance documentation, visit the product page on TE.com>](#)

EU RoHS Directive 2011/65/EU	Compliant
EU ELV Directive 2000/53/EC	Compliant
China RoHS 2 Directive MIIT Order No 32, 2016	No Restricted Materials Above Threshold
EU REACH Regulation (EC) No. 1907/2006	Current ECHA Candidate List: JUNE 2024 (241) Candidate List Declared Against: JUNE 2024 (241) Does not contain REACH SVHC
Halogen Content	Low Halogen - Br, Cl, F, I < 900 ppm per homogenous material. Also BFR/CFR/PVC Free
Solder Process Capability	Not applicable for solder process capability

#### Product Compliance Disclaimer

This information is provided based on reasonable inquiry of our suppliers and represents our current actual knowledge based on the information they provided. This information is subject to change. The part numbers that TE has identified as EU RoHS compliant have a maximum concentration of 0.1% by weight in homogenous materials for lead, hexavalent chromium, mercury, PBB, PBDE, DBP, BBP, DEHP, DIBP, and 0.01% for cadmium, or qualify for an exemption to these limits as defined in the Annexes of Directive 2011/65/EU (RoHS2). Finished electrical and electronic equipment products will be CE marked as required by Directive 2011/65/EU. Components may not be CE marked. Additionally, the part numbers that TE has identified as EU ELV compliant have a maximum concentration of 0.1% by weight in homogenous materials for lead, hexavalent chromium, and mercury, and 0.01% for cadmium, or qualify for an exemption to these limits as defined in the Annexes of Directive 2000/53/EC (ELV). Regarding the REACH Regulation, the information TE provides on SVHC in articles for this part number is based on the latest European Chemicals Agency (ECHA) 'Guidance on requirements for substances in articles' posted at this URL: <https://echa.europa.eu/guidance-documents/guidance-on-reach>



## Compatible Parts



## Customers Also Bought

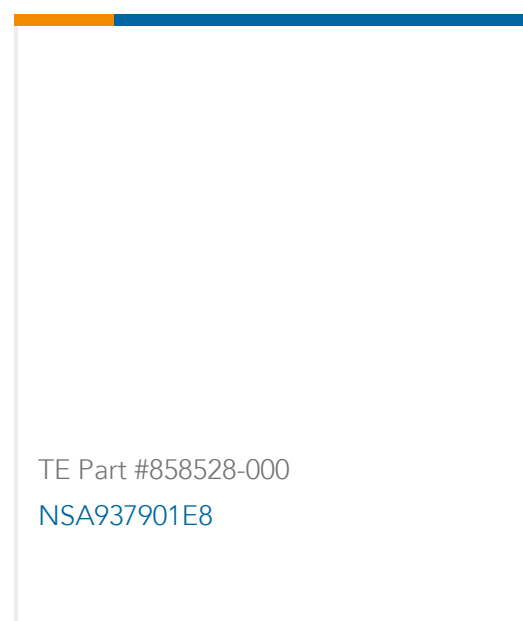
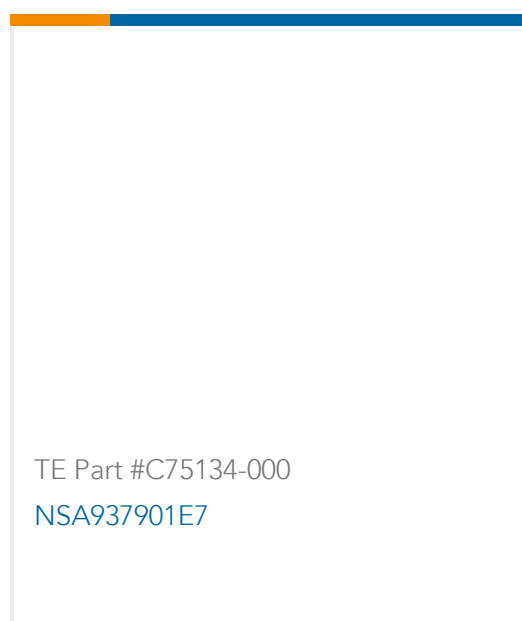
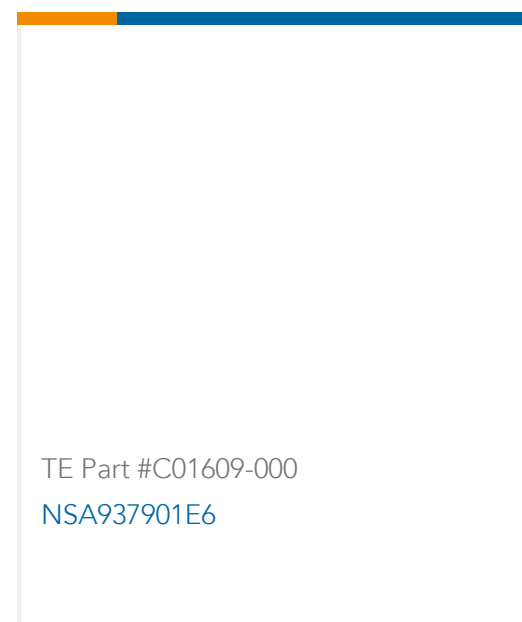
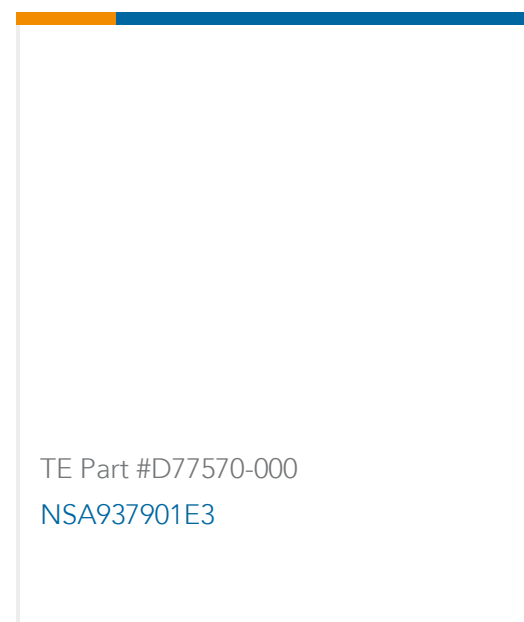
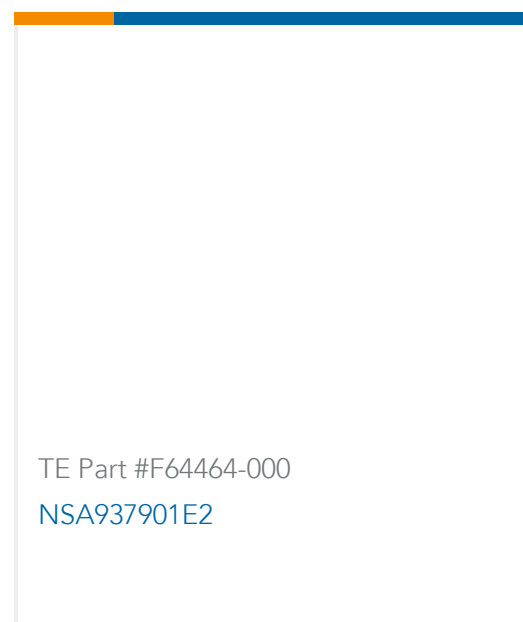
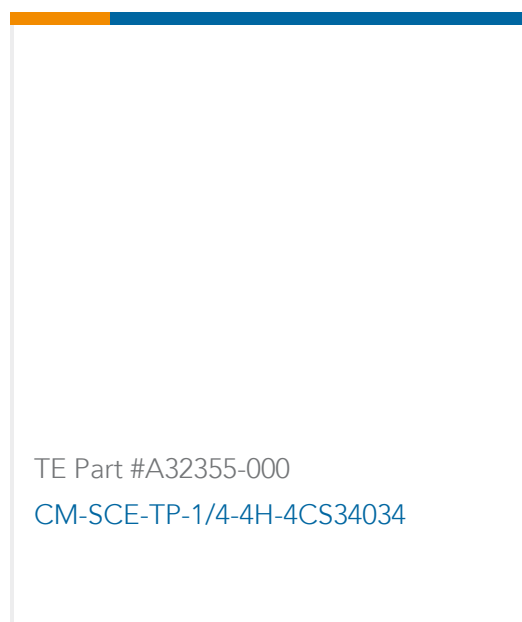
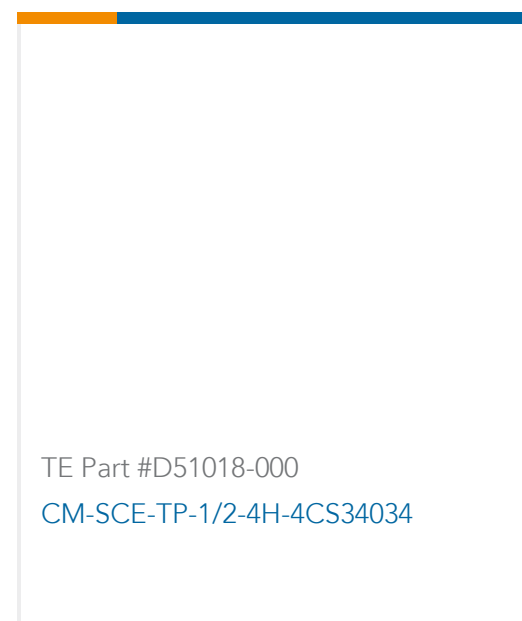
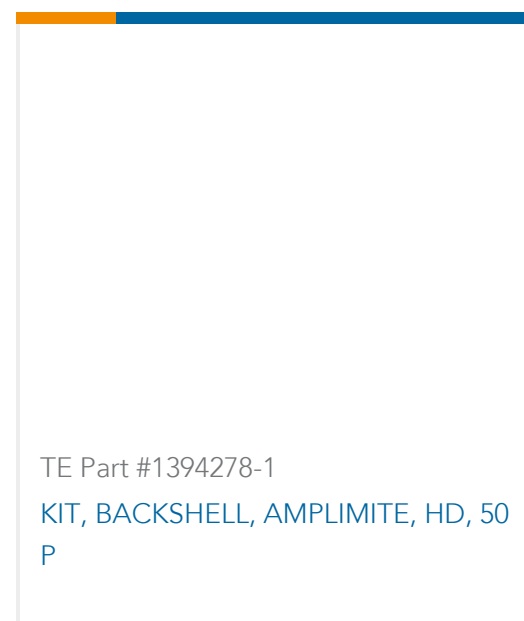
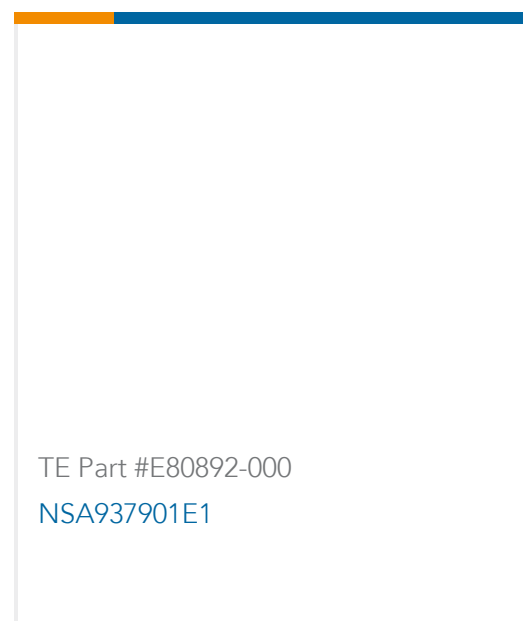
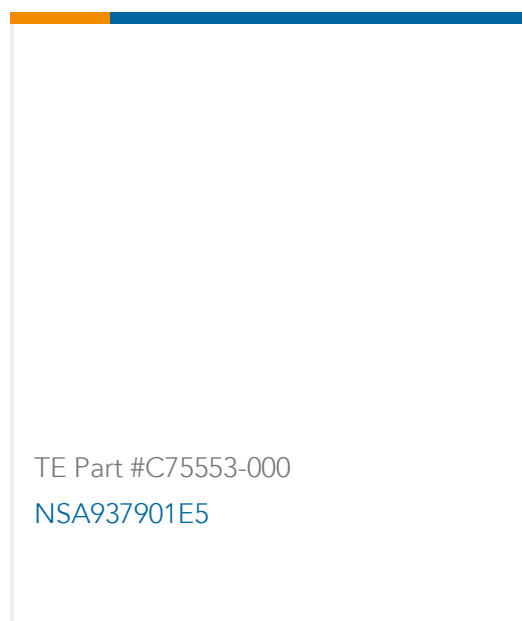

## Documents

### Product Drawings

[TERM, SOLIS, SPADE, 22-16, M4\(8\)](#)

English

### CAD Files

[Customer View Model](#)

[ENG\\_CVM\\_CVM\\_130519\\_D.2d\\_dxf.zip](#)

130519

Spade Tongue Terminal, 22 – 16 AWG, M4 Stud Size, 4.3 mm [.169 in] Stud Diameter,  
Closed Barrel, Straight, Tin, Uninsulated



English

[3D PDF](#)

3D

Customer View Model

[ENG\\_CVM\\_CVM\\_130519\\_D.3d\\_igs.zip](#)

English

Customer View Model

[ENG\\_CVM\\_CVM\\_130519\\_D.3d\\_stp.zip](#)

English

By downloading the CAD file I accept and agree to the [Terms and Conditions](#) of use.

[Agency Approvals](#)

[UL Report](#)

English