

PLEASE CHECK WWW.MOLEX.COM FOR LATEST PART INFORMATION

Part Number: [130013-0620](#)
Status: **Active**
Overview: Brad® Mini-Change® Connectors
Description: Mini-Change® A-Size Flanged Receptacle with Leads, Straight Male, 6 Poles, Length 0.305m , 16 AWG, PVC

Documents:

[Drawing \(PDF\)](#) [RoHS Certificate of Compliance \(PDF\)](#)

Agency Certification

CSA LR6837
 UL E152210

General

Product Family Industrial Receptacles
 Series [130013](#)
 IP Rating IP67
 NEMA Rating NEMA 6
 Overview [Brad® Mini-Change® Connectors](#)
 Product Name Mini-Change®
 Type Single Ended (pigtail)
 UPC 78678843956

Physical

Coupling Type External Thread
 Gender Male
 Keyway Single
 Length 0.305m
 Material - Component Gray Anodized Aluminum
 Mounting Thread Size N/A
 Net Weight 477.310/g
 Orientation Straight
 Panel Mount Front
 Poles 6
 Temperature Range - Operating -20°C to +105°C
 Wire Size AWG 16
 Wire/Cable Type E152210

Electrical

Current - Maximum per Contact 8A
 Voltage - Maximum 600V AC/DC

Material Info

Old Part Number 1R6G06A20A120

Reference - Drawing Numbers

Sales Drawing SD-130013-022

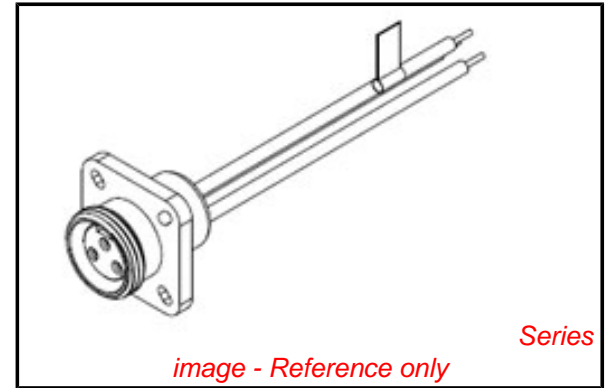

image - Reference only

EU RoHS

**ELV and RoHS
 Compliant
 REACH SVHC
 Not Reviewed
 Low-Halogen Status
 Not Reviewed**

China RoHS



Need more information on product environmental compliance?

Email productcompliance@molex.com
 For a multiple part number RoHS Certificate of Compliance, [click here](#)

Please visit the [Contact Us](#) section for any non-product compliance questions.

Search Parts in this Series

130013Series