

PLEASE CHECK WWW.MOLEX.COM FOR LATEST PART INFORMATION

Part Number: [130013-0581](#)
Status: **Active**
Overview: Brad® Mini-Change® Connectors
Description: Mini-Change® A-Size Receptacle with Leads 1/2" - 14NPT Threads, Straight Female, 6 Poles, Length 3.05m

Documents:

[Drawing \(PDF\)](#) [RoHS Certificate of Compliance \(PDF\)](#)

Agency Certification

CSA LR6837
 UL E152210

General

Product Family Industrial Receptacles
 Series [130013](#)
 IP Rating IP67
 NEMA Rating NEMA 6
 Overview [Brad® Mini-Change® Connectors](#)
 Product Name Mini-Change®
 Type Single Ended (pigtail)
 UPC 78678834365

Physical

Coupling Type External Thread
 Gender Female
 Keyway Single
 Length 3.04m
 Material - Component Zinc Die-Cast with Black Epoxy
 Mounting Thread Size 1/2" - 14 NPT
 Net Weight 601.370g
 Orientation Straight
 Panel Mount N/A
 Poles 6
 Temperature Range - Operating -20°C to +105°C
 Wire Size AWG 16
 Wire/Cable Type N/A

Electrical

Current - Maximum per Contact 8A
 Voltage - Maximum 600V AC/DC

Material Info

Old Part Number 1R6004A20F100

Reference - Drawing Numbers

Sales Drawing SD-130013-002

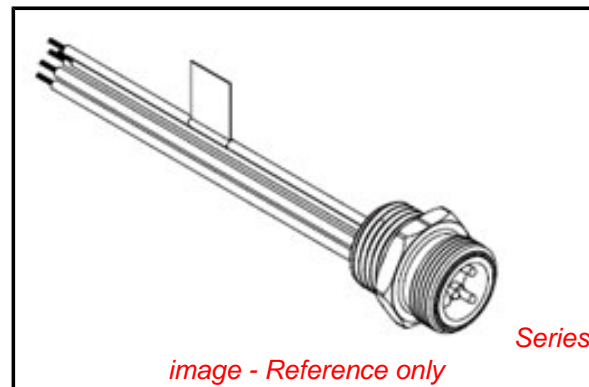

EU RoHS

RoHS Compliant by Exemption
REACH SVHC
 Not Reviewed
Low-Halogen Status
 Not Reviewed

China RoHS



Need more information on product environmental compliance?

Email productcompliance@molex.com
 For a multiple part number RoHS Certificate of Compliance, [click here](#)

Please visit the [Contact Us](#) section for any non-product compliance questions.

Search Parts in this Series

130013Series