

**PLEASE CHECK WWW.MOLEX.COM FOR LATEST PART INFORMATION**

**Part Number:** [130013-0550](#)  
**Status:** **Active**  
**Overview:** Brad® Mini-Change® Connectors  
**Description:** Mini-Change® A-Size Flanged Receptacle with Leads, Straight Female, 5 Poles, Length 0.305m , 16 AWG, PVC

**Documents:**

[Drawing \(PDF\)](#) [RoHS Certificate of Compliance \(PDF\)](#)

**Agency Certification**

CSA LR6837  
 UL E152210

**General**

Product Family Industrial Receptacles  
 Series [130013](#)  
 IP Rating IP67  
 NEMA Rating NEMA 6  
 Overview [Brad® Mini-Change® Connectors](#)  
 Product Name Mini-Change®  
 Type Single Ended (pigtail)  
 UPC 78678843930

**Physical**

Coupling Type External Thread  
 Gender Female  
 Keyway Single  
 Length 0.305m  
 Material - Component Gray Anodized Aluminum  
 Mounting Thread Size N/A  
 Orientation Straight  
 Panel Mount Front  
 Poles 5  
 Temperature Range - Operating -20°C to +105°C  
 Wire Size AWG 16  
 Wire/Cable Type E152210

**Electrical**

Current - Maximum per Contact 8A  
 Voltage - Maximum 600V AC/DC

**Material Info**

Old Part Number 1R5G04A20A120

**Reference - Drawing Numbers**

Sales Drawing SD-130013-018

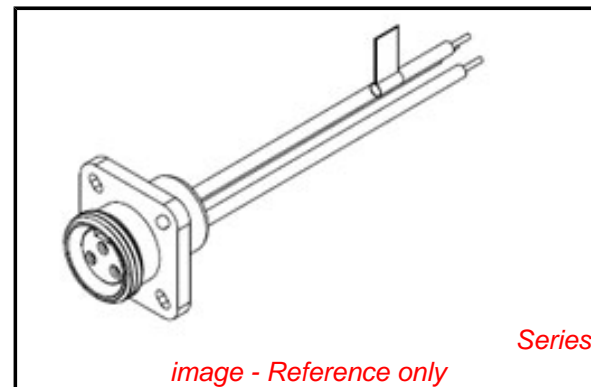

image - Reference only

**EU RoHS**

**RoHS Compliant by Exemption**  
**REACH SVHC Not Reviewed**  
**Low-Halogen Status Not Reviewed**

**China RoHS**



**Need more information on product environmental compliance?**

Email [productcompliance@molex.com](mailto:productcompliance@molex.com)  
 For a multiple part number RoHS Certificate of Compliance, [click here](#)

Please visit the [Contact Us](#) section for any non-product compliance questions.

**Search Parts in this Series**

130013Series