

PLEASE CHECK WWW.MOLEX.COM FOR LATEST PART INFORMATION

Part Number: [1300130399](#)
Status: **Active**
Overview: [Brad Mini-Change Connectors](#)
Description: Mini-Change Receptacle, 4 Poles, Panel Mount, PG 13.5 Threads, Male (Straight) to 18 AWG Leads, 1.0m (3.28') Length

Documents:

[Drawing \(PDF\)](#) [RoHS Certificate of Compliance \(PDF\)](#)

Agency Certification

CSA LR6837

General

Product Family Industrial Receptacles
 Series [130013](#)
 IP Rating IP67
 NEMA Rating NEMA 6
 Overview [Brad Mini-Change Connectors](#)
 Product Name Mini-Change
 Type Single Ended (pigtail)
 UPC 78678841945

Physical

Coupling Type External Thread
 Gender Male
 Keyway Single
 Length 1.0m
 Material - Component PVC
 Mounting Thread Size PG13.5
 Orientation Straight
 Panel Mount Front
 Poles 4
 Temperature Range - Operating -20°C to +105°C
 Wire Size AWG 18
 Wire/Cable Type UL 1061

Electrical

Current - Maximum per Contact 5.6A
 Voltage - Maximum 300V AC/DC

Material Info

Engineering Number 1R4D06A16M010

Reference - Drawing Numbers

Sales Drawing SD-130013-006

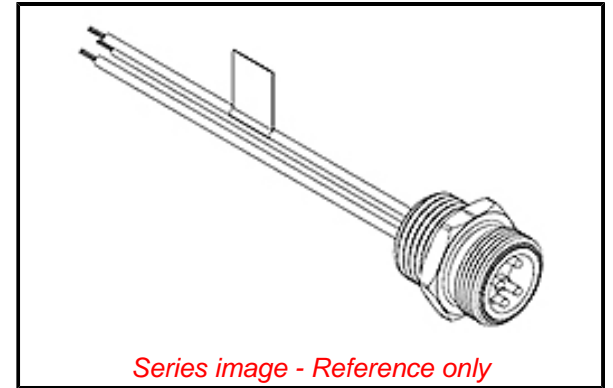

Series image - Reference only

EU ELV

Not Reviewed

EU RoHS

Not Reviewed

REACH SVHC

Not Reviewed

Halogen-Free

Status

Not Reviewed

For more information, please visit [Contact US](#)

China ROHS

Not Reviewed

ELV

Not Reviewed

RoHS Phthalates

Not Reviewed

Search Parts in this Series

[130013 Series](#)