

SCHMATY POLACZEN/WIREING CONFIGURATION

TAMPONADRUK SCHEMATU(PATRZ ROZKODOWANIE) /BIALY  
CIRCUIT PRINTOUT(SEE MPM PART NUMBER CODE)/WHITE

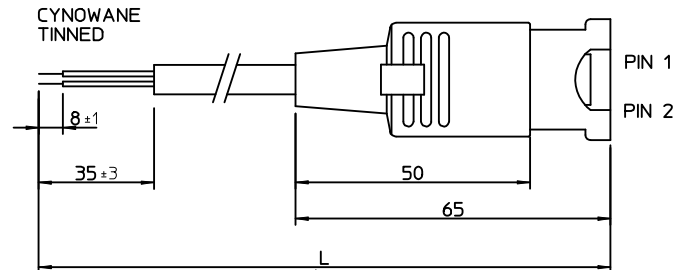

PATRZ UWAGA 1  
SEE NOTE 1

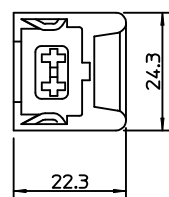
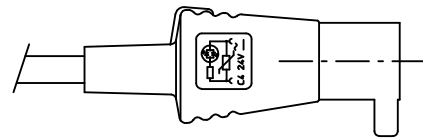
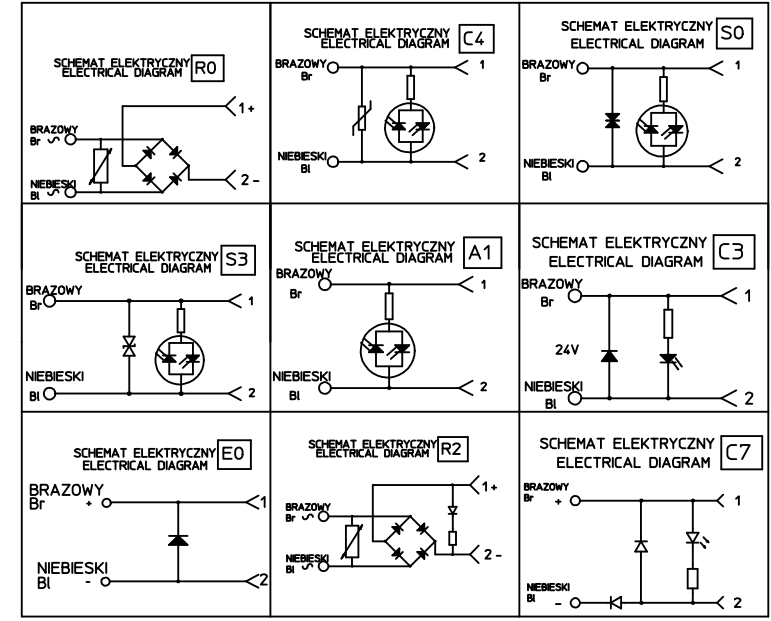

Table of length tolerances/ Tablica tolerancji dlugosci mm		
Over/Od	Up to and including/ Do-wlacznie	Tolerance/Tolerancja
100	1000	±20
1000	3000	±30
3000	5000	±40
5000	10000	±50
10000	15000	±100
15000	20000	±150
20000		±L/100

UWAGI:  
1. DLUGOSC PATRZ ARKUSZ 2.

NOTES:  
1. LENGTH SEE SHEET 2.

ORIGINAL RELEASE EC NO: WEU2009-0449 DRWIN: MWOLSZCZAK 2009/06/30 CHYKD: MDABROWSKA 2009/07/01 APPR: GOGRODNIK 2009/07/01	QUALITY SYMBOLS	GENERAL TOLERANCES (UNLESS SPECIFIED)		DIMENSION STYLE MM ONLY		SCALE ---	DESIGN UNITS METRIC	FIRST ANGLE PROJECTION	
	▽=0	mm	INCH	DRAWN BY	DATE	TITLE			
	∇=0	4 PLACES ± --- ± ---	3 PLACES ± --- ± ---	MLEVYTSKYY	2009/04/20	MPM EJ1XXXXXXXXXX			
		2 PLACES ± --- ± ---	1 PLACE ± --- ± ---	CHECKED BY	DATE	MOLEX INCORPORATED			
	ANGULAR ± --- °	DRAFT WHERE APPLICABLE MUST REMAIN WITHIN DIMENSIONS		APPROVED BY	DATE	DOCUMENT NO.		SHEET NO.	
				MATERIAL NO.		EJT1XXXXXXXXXX		1 OF 4	
				SIZE	THIS DRAWING CONTAINS INFORMATION THAT IS PROPRIETARY TO MOLEX INCORPORATED AND SHOULD NOT BE USED WITHOUT WRITTEN PERMISSION				
				A3					

# PN KEY

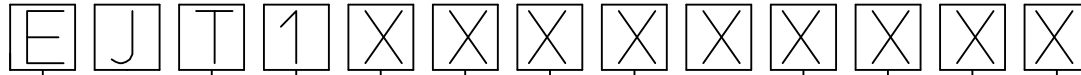

JUNIOR CONNECTORS

CONNECTOR TYPE:

1 - STRAIGHT, 2 WIRES, SINGLY ENDED

CABLE TYPE, SEE SHEET 2, CHART 1 AND CHART 2

HEAD COLOR:

N=BLACK; A=CSA-UL BLACK;

CABLE LENGTH IN CENTIMETRES:

EXAMPLE: 050=50 CM, 300=300 CM.

INTERNAL CIRCUIT

SEE WIRING CONFIGURATION

VOLTAGE AND LED COLOUR:

- 1= 12V
  - 2= 24V
  - 3= 48V
  - 4= 115V
  - 5= 230V
- RED LED

- A= 12V
  - B= 24V
  - C= 48V
  - D= 115V
  - E= 230V
- GREEN LED

- G= 12V
  - H= 24V
  - K= 48V
  - L= 115V
  - M= 230V
- YELLOW LED

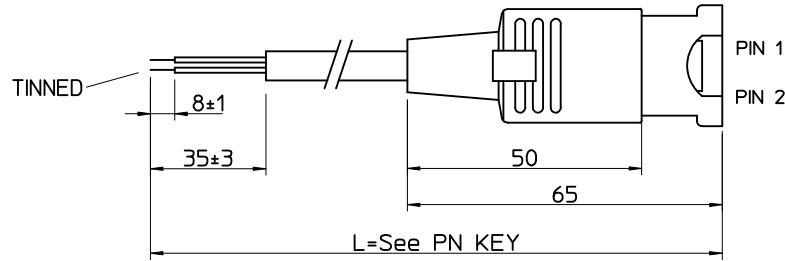

FACE VIEW

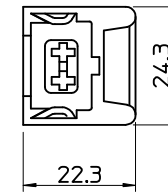

CIRCUIT PRINTOUT/WHITE

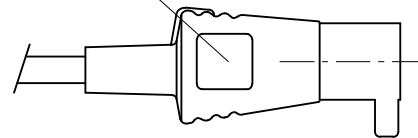

# WIRING CONFIGURATION

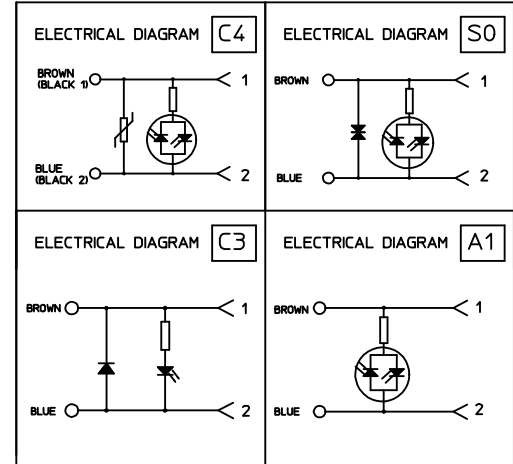

Over	Up to and including	Tolerance
0	1000	±20
1000	3000	±30
3000	5000	±40
5000	10000	±50
10000	15000	±100
15000	20000	±150
20000		±L/100

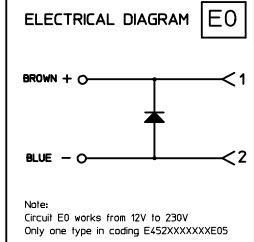

ORIGINAL RELEASE EC NO: IPG2014-1897 DRWN: JMARSZALEK 2013/06/10 CHKD: DSTACHOWIAK 2014/05/07 APPR: MIWASIECZKO 2014/05/08	QUALITY SYMBOLS ▽=0 ◻=0	GENERAL TOLERANCES (UNLESS SPECIFIED)		DIMENSION STYLE MM ONLY		SCALE -	DESIGN UNITS METRIC	THIRD ANGLE PROJECTION		
			mm	INCH	DRAWN BY JMARSZALEK	DATE 2013/06/10	TITLE JUNIOR TIMER CONNECTORS EJT1XXXXXXXXX			
		4 PLACES	± ---	± ---	CHECKED BY DSTACHOWIAK	DATE 2014/05/07				
		3 PLACES	± ---	± ---	APPROVED BY MIWASIECZKO	DATE 2014/05/08				
2 PLACES	± ---	± ---	ANGULAR ± --- °		MATERIAL NO.	DOCUMENT NO.		SHEET NO.		
1 PLACE	± ---	± ---	DRAFT WHERE APPLICABLE MUST REMAIN WITHIN DIMENSIONS		SIZE A3	SEE PN KEY		SD-121056-002		
0 PLACE	± ---	± ---	THIS DRAWING CONTAINS INFORMATION THAT IS PROPRIETARY TO MOLEX INCORPORATED AND SHOULD NOT BE USED WITHOUT WRITTEN PERMISSION							

TABELA 2 KABLE / TABLE 2 CABLES

Molex PN Raw cable	Cable type	Cable code	Wires no.	Cross Section	Jacket material	Jacket color	Diameter Ø [mm]	Wire colors
1202091424	I	0	3	1 mm <sup>2</sup>	PVC CEI 2022 II O.R.	Grey	7.6±0.2	BN, BU, GN/YE
1210180467	A	2	2	20 AWG	PVC CSA/UL 2661	Black	5.4±0.2	BN, BU
1210180128	A	2	3	20 AWG	PVC CSA/UL 2661	Black	5.6±0.2	BN, BU, GN/YE
1210180394	A	2	4	20 AWG	PVC CSA/UL 2661	Black	6.2±0.25	BN, BU, BK, GN/YE
1210180297	B	2	2	20 AWG	PUR CSA/UL 20668	Black	5.6±0.2	BN, BU
1210180126	B	2	3	20 AWG	PUR CSA/UL 20668	Black	5.6±0.2	BN, BU, GN/YE
1210180387	B	2	4	20 AWG	PUR CSA/UL 20668	Black	6.3±0.2	BN, BU, BK, GN/YE
1210180284	D	2	3	0.5 mm <sup>2</sup>	PVC CEI 20-20	Grey	5.5+0.3/-0	BN, BU, GN/YE
1210180047	I	2	2	0.5 mm <sup>2</sup>	PVC CEI 2022 II O.R.	Grey	5.5+0.3/-0	BN, BU
1210180284	I	2	3	0.5 mm <sup>2</sup>	PVC CEI 2022 II O.R.	Grey	5.5+0.3/-0	BN, BU, GN/YE
1210180146	I	2	4	0.5 mm <sup>2</sup>	PVC CEI 2022 II O.R.	Grey	6.5±0.2	BN, BU, BK, GN/YE
1210180177	I	2	5	0.5 mm <sup>2</sup>	PVC CEI 2022 II O.R.	Grey	7.0 +0.3/-0	BN, BU, BK, WH, GN/YE
1210180022	N	2	2	0.5 mm <sup>2</sup>	PVC H03VV-F	Black	5.2±0.2	BN, BU
1202092753	N	2	3	0.5 mm <sup>2</sup>	PVC H03VV-F	Black	5.5±0.2	BN, BU, GN/YE
1210180153	N	2	4	0.5 mm <sup>2</sup>	PVC H03VV-F	Black	5.9±0.3	BN, BU, BK, GN/YE
1210180046	P	2	2	0.5 mm <sup>2</sup>	PUR - BLEND	Black	5.5±0.2	BN, BU
1202092439	P	2	3	0.5 mm <sup>2</sup>	PUR - BLEND	Black	5.5 +0.3/-0	BN, BU, GN/YE
1210180302	P	2	4	0.5 mm <sup>2</sup>	PUR - BLEND	Black	6.5±0.2	BN, BU, BK, GN/YE
1202092215	P	2	5	0.5 mm <sup>2</sup>	PUR - BLEND	Black	7+0.3/-0.1	BN, BU, BK, WH, GN/YE
1210180409	A	3	2	18 AWG	PVC CSA/UL 2661	Black	6.2±0.25	BN, BU
1210180129	A	3	3	18 AWG	PVC CSA/UL 2661	Black	6.5±0.25	BN, BU, GN/YE
1210180159	A	3	4	18 AWG	PVC CSA/UL 2661	Black	7.0+0.3/-0	BN, BU, BK, GN/YE
1210180484	A	3	5	18 AWG	PVC CSA/UL 2661	Black	7.8±0.25	BN, BU, BK, WH, GN/YE
1210180351	B	3	2	18 AWG	PUR CSA/UL 20668	Black	6.2±0.2	BN, BU
1210180127	B	3	3	18 AWG	PUR CSA/UL 20668	Black	6.5±0.2	BN, BU, GN/YE
1210180160	B	3	4	18 AWG	PUR CSA/UL 20668	Black	7±0.2	BN, BU, BK, GN/YE
1210180463	B	3	5	18 AWG	PUR CSA/UL 20668	Black	7.8±0.25	BN, BU, BK, WH, GN/YE
1210180073	D	3	3	0.75 mm <sup>2</sup>	PVC CEI 20-20	Grey	6.5±0.2	BN, BU, GN/YE
1210180145	D	3	4	0.75 mm <sup>2</sup>	PVC CEI 20-20	Grey	7.1±0.2	BN, BU, BK, GN/YE
1202098206	I	3	2	0.75 mm <sup>2</sup>	PVC CEI 2022 II O.R.	Grey	5.5±0.2	BK1, BK2
1210180120	I	3	3	0.75 mm <sup>2</sup>	PVC CEI 2022 II O.R.	Grey	6.0±0.2	BK1, BK2, BK3
1210180143	I	3	4	0.75 mm <sup>2</sup>	PVC CEI 2022 II O.R.	Grey	7.0±0.2	BN, BU, BK, GN/YE
1210180032	N	3	2	0.75 mm <sup>2</sup>	PVC H05VV-F	Black	6.2±0.2	BN, BU
1210180069	N	3	3	0.75 mm <sup>2</sup>	PVC H05VV-F	Black	6.5±0.2	BN, BU, GN/YE
1210180144	N	3	4	0.75 mm <sup>2</sup>	PVC H05VV-F	Black	7.1±0.2	BN, BU, BK, GN/YE
1210180174	N	3	5	0.75 mm <sup>2</sup>	PVC H05VV-F	Black	8.0+0.2/-0	BN, BU, BK, GY, GN/YE
1202094190	P	3	2	0.75 mm <sup>2</sup>	PUR - BLEND	Black	6.5±0.2	BN, BU
1210180071	P	3	3	0.75 mm <sup>2</sup>	PUR - BLEND	Black	6.5±0.2	BN, BU, GN/YE
1210180152	P	3	4	0.75 mm <sup>2</sup>	PUR - BLEND	Black	7.0±0.2	BN, BU, BK, GN/YE

TABELA 2 KABLE / TABLE 2 CABLES

Molex PN Raw cable	Cable type	Cable code	Wires no.	Cross Section	Jacket material	Jacket color	Diameter Ø [mm]	Wire colors
1210180384	R	3	3	0.75 mm <sup>2</sup>	TPR HAL. FREE	Black	6.5±0.2	BN, BU, GN/YE
1210180094	T	3	3	0.75 mm <sup>2</sup>	PUR CSA/UL 20668	Yellow	6.5±0.2	BN, BU, GN/YE
1210180309	Y	3	3	0.75 mm <sup>2</sup>	SILICONE RUBBER	Red	6.5±0.2	BN, BU, GN/YE
1210180081	F	4	3	1 mm <sup>2</sup>	PVC CNOMO	Grey	7.1+0.2/-0	BK1, BK2, GN/YE
1210180042	I	4	2	1 mm <sup>2</sup>	PVC CEI 2022 II O.R.	Grey	7.1+0.2/-0	BN, BU
1210180079	I	4	3	1 mm <sup>2</sup>	PVC CEI 2022 II O.R.	Grey	7.1+0.2/-0	BN, BU, GN/YE
1210180036	N	4	2	1 mm <sup>2</sup>	PVC H05VV-F	Black	6.5±0.2	BN, BU
1210180082	N	4	3	1 mm <sup>2</sup>	PVC H05VV-F	Black	6.9±0.2	BN, BU, GN/YE
1210180117	R	4	3	1 mm <sup>2</sup>	TPR HAL. FREE	Black	7.1±0.2	BN, BU, GN/YE
1210180085	N	5	3	1.5 mm <sup>2</sup>	PVC H05VV-F	Black	7.9±0.2	BN, BU, GN/YE
1210180313	I	6	2	0.35 mm <sup>2</sup>	PVC CEI 2011	Grey	4.8±0.2	BN, WH
1210180148	I	9	4	0.75 mm <sup>2</sup>	PVC CEI 2022 II	Grey	7.3±0.2	BN, BU, BK, GN/YE

TABLE 1 - CABLES TYPE

Code	Cable types	Features	Cross Section
N	PVC	Application general purpose cable which has good resistance to water, but usually poor oil resistance.	0.5 mm <sup>2</sup> 0.75 mm <sup>2</sup> 1 mm <sup>2</sup>
I	CEI	Approved to IEC 332-2A, flame retardant and self extinguishing. Limited resistant to mineral oils.	0.5 mm <sup>2</sup> 0.75 mm <sup>2</sup> 1 mm <sup>2</sup>
P	PUR	Offer good resistance to oil and chemicals. Can swell when constantly immersed in water.	0.5 mm <sup>2</sup> 0.75 mm <sup>2</sup> 1 mm <sup>2</sup>
A	PVC CSA-UL	Approved to CSA-UL 2661, application general purpose cable which has good resistance to water, but usually poor oil resistance.	20 AWG 18 AWG
B	PUR CSA-UL	Approved to CSA-UL 20668, very good resistance to oil and chemicals.	20 AWG 18 AWG

ORIGINAL RELEASE EC NO: IPG2014-1897 DRWN: JMARSZALEK 2013/06/11 CHKD: DSTACHOWIAK 2014/05/07 APPR: MIWASIECZKO 2014/05/08	QUALITY SYMBOLS ▽=0 ◻=0	GENERAL TOLERANCES (UNLESS SPECIFIED)		DIMENSION STYLE MM ONLY		SCALE -	DESIGN UNITS METRIC	THIRD ANGLE PROJECTION	
			mm	INCH	DRAWN BY JMARSZALEK	DATE 2013/06/11	TITLE JUNIOR TIMER CONNECTORS EJT1XXXXXXXXXX		
			± ---	± ---	CHECKED BY DSTACHOWIAK	DATE 2014/05/07			
			± ---	± ---	APPROVED BY MIWASIECZKO	DATE 2014/05/08			
	ANGULAR ± --- °		MATERIAL NO.		DOCUMENT NO.		SHEET NO.		
	DRAFT WHERE APPLICABLE MUST REMAIN WITHIN DIMENSIONS		MATRIX DRAWING		SD-121056-002		2 OF 2		
	THIS DRAWING CONTAINS INFORMATION THAT IS PROPRIETARY TO MOLEX INCORPORATED AND SHOULD NOT BE USED WITHOUT WRITTEN PERMISSION								