

PLEASE CHECK WWW.MOLEX.COM FOR LATEST PART INFORMATION

Part Number: [121023-0467](#)
Status: **Active**
Overview: Brad® mPm® DIN Valve Connectors
Description: mPm® DIN Valve Connector, Type C, 3 Pole, PG7, Black Nitrile Flat Gasket

Documents:

[Drawing \(PDF\)](#) [RoHS Certificate of Compliance \(PDF\)](#)
[Packaging Specification PK-121023-C19 \(PDF\)](#)

General

Product Family	Field Attachable / Accessories
Series	121023
IP Rating	IP67
Overview	Brad® mPm® DIN Valve Connectors
Product Name	mPm®
Type	Field Attachable Connector
UPC	883906249090

Physical

Cable Diameter	N/A
Coupling Type	Internal Thread
Diagnostics / LEDs	No
Diagnostics Port	No
Gender	N/A
Keyway	None
Material - Connector Body	Polypropylene
Material - Contact	Brass
Material - Coupling Nut	N/A
Material - Plating Mating	Silver
Net Weight	11.075/g
Orientation	90° Angle
Poles	3
Temperature Range - Operating	-40°C to +90°C
Wire Size AWG	N/A

Electrical

Current - Maximum per Contact	16A
Voltage - Maximum	250V AC / 300V DC

Material Info

Old Part Number	C19307N62
-----------------	-----------

Reference - Drawing Numbers

Packaging Specification	PK-121023-C19
Sales Drawing	SD-121023-005

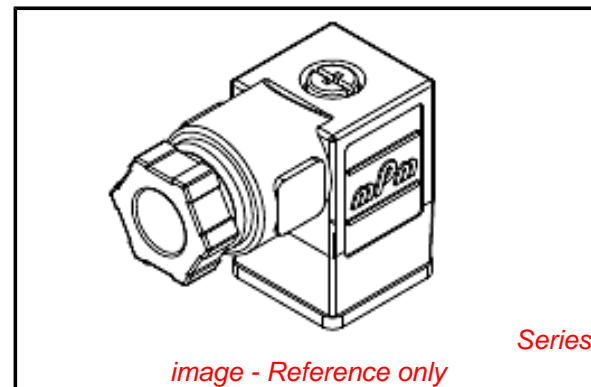

image - Reference only

EU RoHS

RoHS Compliant by Exemption

REACH SVHC

Not Reviewed

Low-Halogen Status

Low-Halogen

China RoHS



Need more information on product environmental compliance?

Email productcompliance@molex.com
 For a multiple part number RoHS Certificate of Compliance, [click here](#)

Please visit the [Contact Us](#) section for any non-product compliance questions.

Search Parts in this Series

[121023Series](#)