

ENGINEERING NO. - NUMERICAL CODE (Available parts see PART LIST table. Other parts available upon request).

8 8 X 0 X 1 X X X X X X X X

OPTIONS

88=Micro-Change
M12x1
Double ended

Contacts:
3=3 Contacts
4=4 Contacts
5=5 Contacts
8=8 Contacts

Heads style:
031=Plug Female 90°
to Plug Male Straight
021=Plug Female 90°
to Plug Male Straight
with Female
Coupling Nut

Cable type: See Table

Units:
M=Meter
C=Centimeter

Length
Examples:
005=0.5 unit
010=1 unit
100=10 units

Coupling Nut:
Blank (Standard)=Knurled Brass Ni Plated
1=Hexagonal Stainless steel
5=Knurled Derlin
7=Knurled Brass Ni Plated, Teflon Coated
Blank=7 for cables I20, I26, K03, K05, P82, S26
9=Knurled / Hexagonal Brass Ni Plated SW13

H= 2 pcs. of I/D Carrier PVC Transparent
(Cables Ixx & P82 always with 2 pcs. of
I/D Carrier even if no H in Engineering No.)

Overmold color:
Blank (Standard)=Black TPU
Blank=Yellow PVC for cables
A09, S19, S20, S26
Blank=Yellow TPE-E for cables
K03, K05
A=Grey / G=Black / Y=Yellow

**COUPLING NUT
FEMALE MALE**

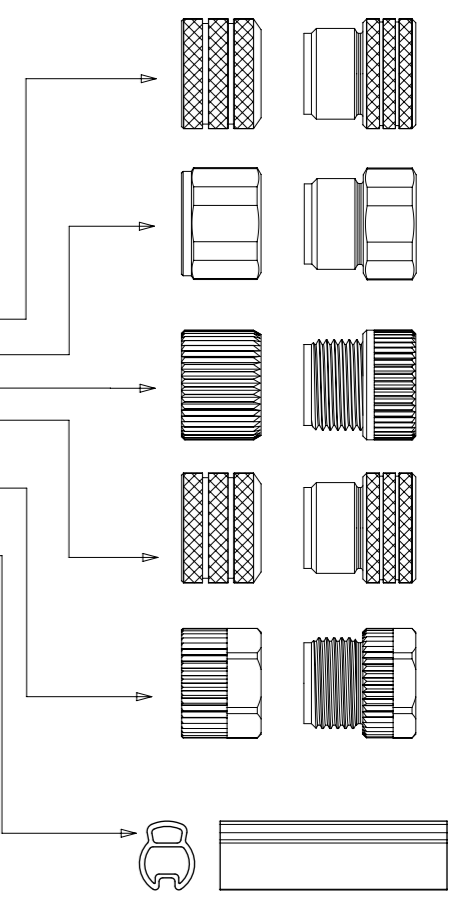

CABLE INFORMATION (for more information see Cable Data Sheet).

CABLE TYPE	NO. OF WIRES	CROSS SECTION	CABLE JACKET	UL	CSA	STATIC: TEMP. / BENDING RADIUS	DYNAMIC: TEMP. / BENDING RADIUS	DRAG CHAIN	SHIELD
B02	4	18AWG	PUR YELLOW	UL 20549	I/II A/B 80°C/300V	-	-	-	-
I03	3 / 4 / 5	0.34mm ²	PVC CEI GREY	-	-	-30°C to +70°C	-5°C to +70°C	-	-
I20	3 / 4	0.34mm ²	PVC CEI GREY	-	-	-30°C to +70°C	-5°C to +70°C	-	YES
I26	5	0.34mm ²	PVC CEI GREY	-	-	-30°C to +70°C	-5°C to +70°C	-	YES
K03	4	18AWG	TPE YELLOW	UL ITC or PLC	I/II A/B 90°C/300V	max 105°C	-	-	-
K05	3 / 4 / 5	22AWG	TPE YELLOW	UL ITC or PLC	I/II A/B 90°C/300V	max 105°C	-	-	-
P82	3 / 4 / 5	0.34mm ²	PUR IRR ORANGE	-	-	-50°C to +105°C, >5xO.D.	-40°C to +105°C, >7.5xO.D.	-	-
S20	3 / 4 / 5	0.34mm ²	PVC YELLOW	UL 2661/1731	C22.2 II A 105°C/300V	-30°C to +105°C	-	-	YES
E02	3 / 4 / 5 / 8	0.25mm ²	PVC BLACK	UL 2464/1729	C22.2 I/II A/B 80°C/300V	-30°C to +80°C, 10xO.D.	-10°C to +80°C, 15xO.D.	-	-
E03	3 / 4 / 5	0.34mm ²	PVC BLACK	UL 2464/1729	C22.2 I/II A/B 80°C/300V	-30°C to +80°C, 10xO.D.	-10°C to +80°C, 15xO.D.	-	-
H09	3 / 4 / 5	0.34mm ²	PUR BLACK LSOH	UL 21198/10493	C22.2 I/II A/B 80°C/300V	-40°C to +80°C, 5xO.D.	-25°C to +80°C, 10xO.D.	2 000 000 cycles at 20°C, Temp. range +5°C to +60°C	-
P03	3 / 4 / 5	0.34mm ²	PUR / PVC BLACK	-	-	-30°C to +80°C, >7xO.D.	-5°C to +80°C, >15xO.D.	-	-

CABLE LENGTH TOLERANCES

OVER	UP TO AND INCLUDING	TOLERANCES
0	305mm	+19mm
305mm	915mm	+45mm
915mm	1830mm	+56mm
1830mm	3660mm	+89mm
3660mm	7320mm	+165mm
7320mm	14640mm	+317mm
14640mm	30500mm	+610mm
30500mm	>	+2% of finished length

THIS DRAWING CONTAINS INFORMATION THAT IS PROPRIETARY TO MOLEX ELECTRONIC TECHNOLOGIES, LLC AND SHOULD NOT BE USED WITHOUT WRITTEN PERMISSION

SYMBOLS: $\nabla = 0$ DIMENSION UNITS: mm SCALE: 1:1

GENERAL TOLERANCES (UNLESS SPECIFIED): ANGULAR TOL $\pm 1.0^\circ$

4 PLACES \pm
3 PLACES \pm
2 PLACES ± 0.05
1 PLACE ± 0.3
0 PLACES ± 0.5

DRAFT WHERE APPLICABLE MUST REMAIN WITHIN DIMENSIONS

THIRD ANGLE PROJECTION

DRAWING: A3-SIZE

SERIES: 120066

MATERIAL NUMBER: SEE PART LIST

CUSTOMER: GENERAL MARKET

SHEET NUMBER: 2 OF 4

CURRENT REV DESC: ADDED NEW PN

EC NO: 619617
DRWN: MDHARMANTI 2019/06/20
CHK'D: RSILLER 2019/06/25
APPR: RSILLER 2019/06/25

INITIAL REVISION:
DRWN: JMARSZALEK 2016/10/06
APPR: RSILLER 2016/12/08

molex

CSE M12 XP AC FE RA MA STR XM DE

PRODUCT CUSTOMER DRAWING

DOCUMENT NUMBER: 1200660973

DOC TYPE: PSD

DOC PART: 000

REVISION: A3

PART LIST

No.	Part No.	Engineering No.	Cable Length
1	1200060052	884031I20M005	0.5m
2	1200060053	884031I20M010	1m
3	1200060054	884031I20M015	1.5m
4	1200060055	884031I20M020	2m
5	1200070132	883031I03M003	0.3m
6	1200070133	883031I03M006	0.6m
7	1200070134	883031I03M010	1m
8	1200070136	883031I03M020	2m
9	1200070137	883031I03M030	3m
10	1200070138	883031I03M050	5m
11	1200070152	883031S20M010	1m
12	1200070153	883031S20M020	2m
13	1200070156	883031S20M050	5m
14	1200070522	884031I03M020	2m
15	1200070523	884031I03M030	3m
16	1200070534	884031S20M030	3m
17	1200070651	884031I03M006	0.6m
18	1200070768	884031S20M050	5m
19	1200070783	884031S20M100H	10m
20	1200071010	884031P82M100	10m
21	1200071096	884031P82M0037	0.3m
22	1200071138	884031S20M010H	1m
23	1200071139	884031S20M020H	2m
24	1200071143	884031P82M0107	1m
25	1200071144	884031P82M0207	2m
26	1200071164	884031S20M003H	0.3m
27	1200071179	884031S20M006H	0.6m
28	1200071183	884031S20M030H	3m
29	1200071189	884031S20M050H	5m
30	1200071200	884031S20M015H	1.5m
31	1200071236	884031S20M005H	0.5m
32	1200071280	884031S20M040H	4m
33	1200071318	884031P82M0067	0.6m
34	1200071341	884031I20M030	3m
35	1200071493	883031P82M0507	5m

No.	Part No.	Engineering No.	Cable Length
36	1200071575	884031P82M006	0.6m
37	1200071576	884031P82M010	1m
38	1200071577	884031P82M015	1.5m
39	1200071578	884031P82M0307	3m
40	1200071579	884031P82M050	5m
41	1200071581	884031P82M020	2m
42	1200071832	884031I20M050	5m
43	1200071833	884031I20M100	10m
44	1200071893	884031S20M100	10m
45	1200071994	885031P82M0307	3m
46	1200072696	883031S20M010H	1m
47	1200072725	885031I26M005	0.5m
48	1200072726	885031I26M010	1m
49	1200659070	884031I20M010Y	1m
50	1200659071	884031I20M015Y	1.5m
51	1200659072	884031I20M020Y	2m
52	1200659115	884031I20M005Y	0.5m
53	1200660374	884031K05M005	0.5m
54	1200660375	884031K05M006	0.6m
55	1200660376	884031K05M010	1m
56	1200660377	884031K05M015	1.5m
57	1200660378	884031K05M020	2m
58	1200660379	884031K05M030	3m
59	1200660380	884031K05M040	4m
60	1200660381	884031K05M050	5m
61	1200660382	884031K05M060	6m
62	1200660383	884031S20M010	1m
63	1200660546	884031K05M100	10m
64	1200660928	884031B02M005	0.5m
65	1200660929	884031B02M006	0.6m
66	1200660931	884031B02M010	1m
67	1200660935	884031B02M020	2m
68	1200660937	884031B02M030	3m
69	1200660940	884031B02M050	5m
70	1200660942	884031B02M060	6m

No.	Part No.	Engineering No.	Cable Length
71	1200660947	884031B02M100	10m
72	1200660971	884031K03M006	0.6m
73	1200660973	884031K03M010	1m
74	1200660975	884031K03M015	1.5m
75	1200660976	884031K03M020	2m
76	1200660977	884031K03M030	3m
77	1200660978	884031K03M040	4m
78	1200660980	884031K03M050	5m
79	1200660982	884031K03M060	6m
80	1200660983	884031K03M070	7m
81	1200660984	884031K03M090	9m
82	1200660985	884031K03M100	10m
83	1200665007	884031P82M0157	1.5m
84	1200665039	884031S20M003	0.3m
85	1200665053	884031S20M060H	6m
86	1200665074	884031K05M080	8m
87	1200668052	883031S20M006	0.6m
88	1200668071	884031S20M020	2m
89	1200668191	883031S20M030	3m
90	1200668221	884031P82M0407	4m
91	1200668237	883031S20M100	10m
92	1200668247	884031P82M0057	0.5m
93	1200668258	883031I03M080	8m
94	1200668259	884031I20M003	0.3m
95	1200668287	884031I20M025	2.5m
96	1200668392	884031P82M0607	6m
97	1200668531	884031P82M0507	5m
98	1200668532	884031P82M1007	10m
99	1200668647	884031P82M0067Y	0.6m
100	1200668666	884031P82M0107Y	1m
101	1200668667	884031I20M030Y	3m
102	1200070443	884021S20M003	0.3m
103	1200070444	884021S20M006	0.6m
104	1200070445	884021S20M010	1m
105	1200070446	884021S20M020	2m

Pos.	Part No.	Engineering No.	Cable Length
106	1200070447	884021S20M030	3m
107	1200070449	884021S20M050	5m
108	1200668042	883021S20M006	0.6m
109	1200668043	883021S20M020	2m
110	1200668044	883021S20M030	3m
111	1200668160	883021S20M010	1m
112	1200668608	883031E02M020	2m
113	1200668613	883031E02M030	3m
114	1200659035	883031E02M050	5m
115	1200668612	883031E02M100	10m
116	1200668908	883031E03M003H	0.3m
117	1200070118	883031E03M006	0.6m
118	1200668909	883031E03M006H	0.6m
119	1200070119	883031E03M010	1m
120	1200668910	883031E03M010H	1m
121	1200668635	883031E03M010Y	1m
122	1200070945	883031E03M015	1.5m
123	1200668967	883031E03M015H	1.5m
124	1200070121	883031E03M020	2m
125	1200072445	883031E03M020H	2m
126	1200668636	883031E03M020Y	2m
127	1200070123	883031E03M030	3m
128	1200668911	883031E03M030H	3m
129	1200072164	883031E03M040	4m
130	1200668968	883031E03M040H	4m
131	1200070125	883031E03M050	5m
132	1200668912	883031E03M050H	5m
133	1200668175	883031E03M060	6m
134	1200070127	883031E03M100	10m
135	1200658762	883031H09M006	0.6m
136	1200658763	883031H09M010	1m
137	1200658764	883031H09M020	2m
138	1200658765	883031H09M030	3m
139	1200669349	883031H09M030H	3m
140	1200658766	883031H09M040	4m
141	1200658767	883031H09M050	5m
142	1200658768	883031H09M100	10m

SYMBOLS = 0 = 0 = 0 = 0 = 0 = 0 = 0 = 0 = 0	THIS DRAWING CONTAINS INFORMATION THAT IS PROPRIETARY TO MOLEX ELECTRONIC TECHNOLOGIES, LLC AND SHOULD NOT BE USED WITHOUT WRITTEN PERMISSION DIMENSION UNITS: mm SCALE: 1:1	CURRENT REV DESC: ADDED NEW PN EC NO: 619617 DRWN: MDHARMANTI 2019/06/20 CHK'D: RSILLER 2019/06/25 APPR: RSILLER 2019/06/25	 CSE M12 XP AC FE RA MA STR XM DE		
	GENERAL TOLERANCES (UNLESS SPECIFIED) ANGULAR TOL ± 1.0° 4 PLACES ± 3 PLACES ± 2 PLACES ± 0.05 1 PLACE ± 0.3 0 PLACES ± 0.5	INITIAL REVISION: DRWN: JMARSZALEK 2016/10/06 APPR: RSILLER 2016/12/08			
	DRAFT WHERE APPLICABLE MUST REMAIN WITHIN DIMENSIONS THIRD ANGLE PROJECTION DRAWING: SERIES: A3-SIZE MATERIAL NUMBER: 120066 CUSTOMER: SEE PART LIST GENERAL MARKET SHEET NUMBER: 3 OF 4				

Pos.	Part No.	Engineering No.	Cable Length
143	1200070140	883031P03M003	0.3m
144	1200070141	883031P03M006	0.6m
145	1200070142	883031P03M010	1m
146	1200668324	883031P03M010G	1m
147	1200071121	883031P03M010H	1m
148	1200070143	883031P03M020	2m
149	1200668325	883031P03M020G	2m
150	1200668753	883031P03M020H	2m
151	1200070144	883031P03M030	3m
152	1200668326	883031P03M030G	3m
153	1200070145	883031P03M050	5m
154	1200668520	883031P03M070	7m
155	1200070146	883031P03M100	10m
156	1200070507	884031E03M003	0.3m
157	1200070508	884031E03M006	0.6m
158	1200070509	884031E03M010	1m
159	1200668361	884031E03M015	1.5m
160	1200070511	884031E03M020	2m
161	1200070512	884031E03M030	3m
162	1200669260	884031E03M030H	3m
163	1200070904	884031E03M050	5m
164	1200071157	884031E03M060	6m
165	1200071278	884031E03M100	10m
166	1200072365	884031E03M1501	15m
167	1200072011	884031E03M200	20m
168	1200668669	884031H09M006	0.6m
169	1200668846	884031H09M008	0.8m
170	1200668210	884031H09M009	0.9m
171	1200668484	884031H09M010	1m
172	1200668848	884031H09M013	1.3m
173	1200668488	884031H09M015	1.5m
174	1200668845	884031H09M018	1.8m
175	1200668212	884031H09M020	2m
176	1200668847	884031H09M021	2.1m
177	1200668215	884031H09M030	3m
178	1200668670	884031H09M050	5m
179	1200668671	884031H09M100	10m

Pos.	Part No.	Engineering No.	Cable Length
180	1200070526	884031P03M003	0.3m
181	1200070527	884031P03M006	0.6m
182	1200060056	884031P03M010	1m
183	1200060057	884031P03M020	2m
184	1200070529	884031P03M030	3m
185	1200071187	884031P03M050	5m
186	1200072012	884031P03M100	10m
187	1300288001	885031D12M020	2m
188	1200668658	885031E02M020	2m
189	1200668610	885031E02M050	5m
190	1200668660	885031E02M100	10m
191	1200668339	885031E03M006	0.6m
192	1200668189	885031E03M010	1m
193	1200668278	885031E03M020	2m
194	1200668340	885031E03M030	3m
195	1200668279	885031E03M050	5m
196	1200668653	885031E03M070	7m
197	1200668348	885031E03M100	10m
198	1200668761	885031E03M150	15m
199	1200669229	885031H09C250	25m
200	1200668512	885031H09M006	0.6m
201	1200668496	885031H09M010	1m
202	1200668513	885031H09M020	2m
203	1200668514	885031H09M030	3m
204	1200668515	885031H09M050	5m
205	1200668516	885031H09M100	10m
206	1200073085	885031P03M006	0.6m
207	1200668188	885031P03M010	1m
208	1200072376	885031P03M0105	1m
209	1200070917	885031P03M020	2m
210	1200668091	885031P03M025	2.5m
211	1200070919	885031P03M030	3m
212	1200668273	885031P03M050	5m
213	1200073086	885031P03M100	10m
214	1200070434	884021E03M020	2m
215			
216			

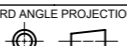
SYMBOLS ▽ = 0 ▽ = 0 ▽ = 0 ▽ = 0 ▽ = 0 ▽ = 0 ▽ = 0 ▽ = 0 ▽ = 0 ▽ = 0	THIS DRAWING CONTAINS INFORMATION THAT IS PROPRIETARY TO MOLEX ELECTRONIC TECHNOLOGIES, LLC AND SHOULD NOT BE USED WITHOUT WRITTEN PERMISSION	DIMENSION UNITS	SCALE	CURRENT REV DESC: ADDED NEW PN			
	mm	1:1	 CSE M12 XP AC FE RA MA STR XM DE				
	GENERAL TOLERANCES (UNLESS SPECIFIED)						
	ANGULAR TOL	± 1.0°					
	4 PLACES	±	EC NO: 619617	INITIAL REVISION:			
	3 PLACES	±	DRWN: MDHARMANTI 2019/06/20	DRWN: JMARSZALEK 2016/10/06			
	2 PLACES	± 0.05	CHK'D: RSILLER 2019/06/25	APPR: RSILLER 2019/06/25			
	1 PLACE	± 0.3	APPR: RSILLER 2019/06/25	APPR: RSILLER 2016/12/08			
	0 PLACES	± 0.5	DRAFT WHERE APPLICABLE MUST REMAIN WITHIN DIMENSIONS		THIRD ANGLE PROJECTION	DRAWING	SERIES
	▣ = 0					A3-SIZE	120066
▽ = 0				MATERIAL NUMBER	CUSTOMER	SHEET NUMBER	
				1200660973	GENERAL MARKET	4 OF 4	

FEMALE PLUG M12 90° ANGLED TO MALE PLUG M12 STRAIGHT

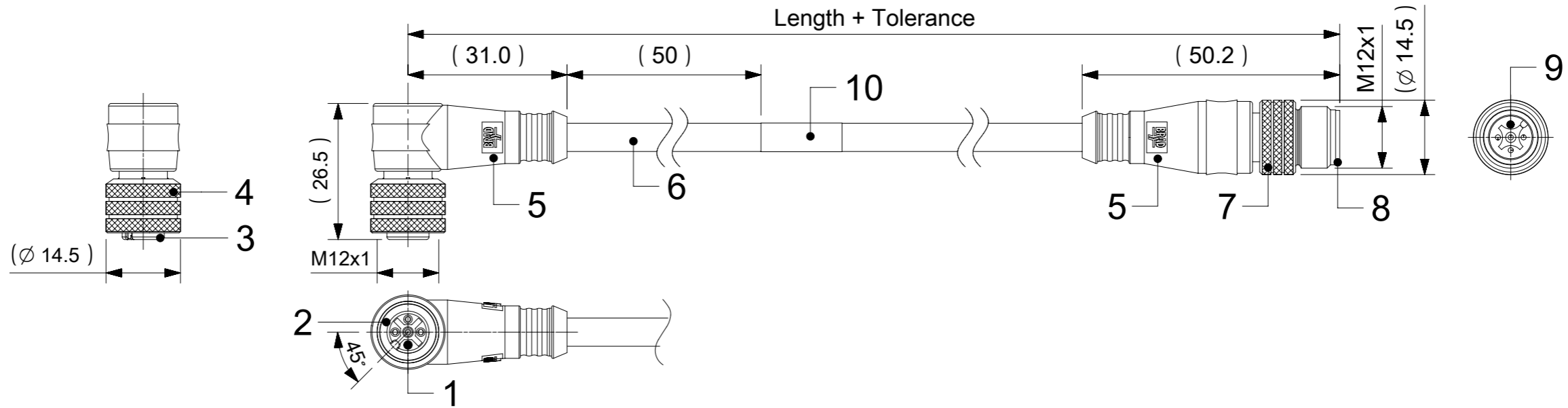

NOTES:

RATED VOLTAGE: 3, 4 contacts 250V per IEC 60664
 5 contacts 60V per IEC 60664
 5 contacts 250V per UL 2238
 8 contacts 30V per IEC 60664

RATED CURRENT: 3, 4, 5 contacts 4A
 8 contacts 2A

PROTECTION CLASS: IP 67
 TEMPERATURE: -25°C / +85°C

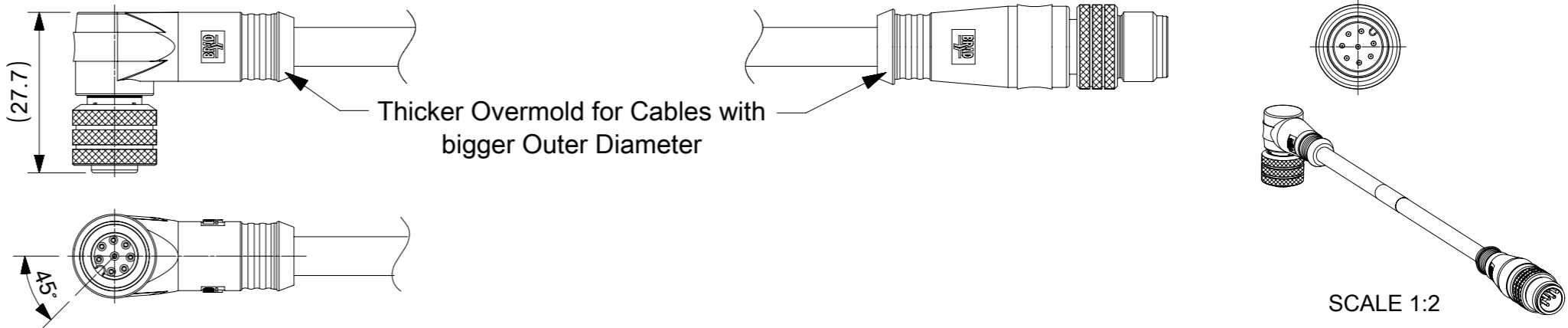

SCALE 1:2

CONTACTS POSITION FRONT VIEW:

	3 CONTACTS		4 CONTACTS		5 CONTACTS		8 CONTACTS	
FEMALE								
MALE								
CONNECTIONS	PIN	WIRE	PIN	WIRE	PIN	WIRE	PIN	WIRE
	1	BROWN	1	BROWN	1	BROWN	1	WHITE
	2	---	2	WHITE	2	WHITE	2	BROWN
	3	BLUE	3	BLUE	3	BLUE	3	GREEN
	4	BLACK	4	BLACK	4	BLACK	4	YELLOW
	5	---	5	---	5	GREY	5	GREY
							6	PINK
							7	BLUE
						8	RED	

CODING REQUIRED TO IEC 61076-2-101

FOR OPTIONS SEE - NUMERICAL CODE - ON SHEET 2

ITEM	QTY.	DESCRIPTION	MATERIAL	FINISH
10	1	LABEL YELLOW	VINYL	---
9	3 / 4 / 5 / 8	CONTACT MALE	BRASS	SELECTIVE Au OVER Ni
8	1	INSERT MALE BLACK	TPU	---
7	1	COUPLING NUT MALE	BRASS	NICKEL
6	-	CABLE	SEE SHEET 2	---
5	-	OVERMOULDING BLACK	TPU	---
4	1	COUPLING NUT FEMALE	BRASS	NICKEL
3	1	INSERT FEMALE BLACK	PUR	---
2	1	ORING RED	FPM	---
1	3 / 4 / 5 / 8	CONTACT FEMALE	BRASS	SELECTIVE Au OVER Ni

THIS DRAWING CONTAINS INFORMATION THAT IS PROPRIETARY TO MOLEX ELECTRONIC TECHNOLOGIES, LLC AND SHOULD NOT BE USED WITHOUT WRITTEN PERMISSION

QUALITY SYMBOLS	EC NO: 177711 DRWN: SSM CHK'D: SSM APPR: THAERDT	2017/12/07 2018/06/06 2018/06/06	GENERAL TOLERANCES (UNLESS SPECIFIED) ANGULAR TOL ± 1.0 ° 4 PLACES ± 3 PLACES ± 2 PLACES ± 0.05 1 PLACE ± 0.3 0 PLACES ± 0.5 DRAFT WHERE APPLICABLE MUST REMAIN WITHIN DIMENSIONS	DIMENSION UNITS: mm SCALE: 1:1 DRWN BY: JMARSZALEK DATE: 2016/10/05 CHK'D BY: DATE: APPR BY: RSILLER DATE: 2016/12/08 DRAWING SIZE: A3 THIRD ANGLE PROJECTION	 CSE M12 XP AC FE RA MA STR XM DE PRODUCT CUSTOMER DRAWING SERIES: 120066 MATERIAL NUMBER: SEE SHEET 3 CUSTOMER: GENERAL MARKET DOCUMENT NUMBER: 1200668189 DOC TYPE: PSD DOC PART: 000 SHEET NUMBER: 1 OF 3
-----------------	---	--	--	--	---

ENGINEERING NO. - NUMERICAL CODE (Available parts see PART LIST table. Other parts available upon request).

8 8 X 0 3 1 X X X X X X X X

OPTIONS

88=Micro-Change
M12x1
Double ended

Contacts:
3=3 Contacts
4=4 Contacts
5=5 Contacts
8=8 Contacts

Heads style:
031=Plug Female 90°
to Plug Male Straight

Cable type: See Table

Units:
M=Meter
C=Centimeter

Length
Examples:
005=0.5 unit
010=1 unit
100=10 units

Overmold color:
Blank (Standard)=Black
A=Grey / G=Black / Y=Yellow

Coupling Nut:
Blank (Standard)=Knurled Brass Ni Plated
1=Hexagonal Stainless steel
5=Knurled Delrin
7=Knurled Brass Ni Plated, Teflon Coated
9=Knurled / Hexagonal Brass Ni Plated SW13

H= 2 pcs. of I/D Carrier PVC Transparent

COUPLING NUT
FEMALE MALE

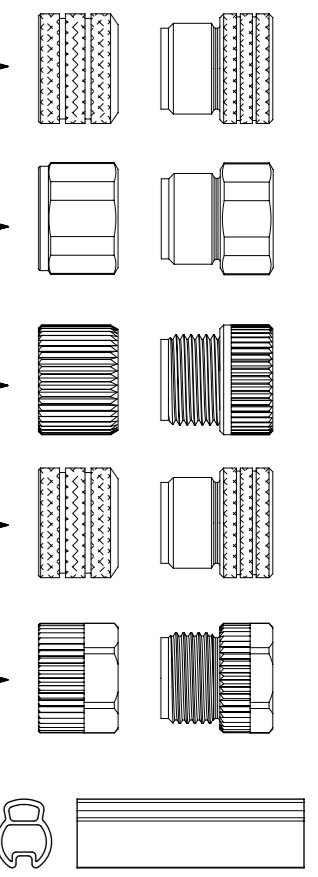

CABLE INFORMATION (for more information see Cable Data Sheet).

CABLE TYPE	NO. OF WIRES	CROSS SECTION	CABLE JACKET	UL	CSA	STATIC: TEMP. / BENDING RADIUS	DYNAMIC: TEMP. / BENDING RADIUS	DRAG CHAIN	SHIELD
E02	3 / 4 / 5 / 8	0.25mm ²	PVC BLACK	UL 2464/1729	C22.2 I/II A/B 80°/300V	-30°C to +80°C, >10xO.D.	-10°C to +80°C, 15xO.D.	-	-
E03	3 / 4 / 5	0.34mm ²	PVC BLACK	UL 2464/1729	C22.2 I/II A/B 80°/300V	-30°C to +80°C, >10xO.D.	-10°C to +80°C, >15xO.D.	-	-
H08	3 / 4 / 5 / 8	0.25mm ²	PUR BLACK LS0H	UL 21198/10493	C22.2 I/II A/B 80°/300V	-40°C to +80°C, >5xO.D.	-25°C to +80°C, >10xO.D.	2 000 000 cycles, Temp max 60°C	-
H09	3 / 4 / 5	0.34mm ²	PUR BLACK LS0H	UL 21198/10493	C22.2 I/II A/B 80°/300V	-40°C to +80°C, >5xO.D.	-25°C to +80°C, >10xO.D.	2 000 000 cycles, Temp max 60°C	-
P02	3 / 4 / 5 / 8	0.25mm ²	PUR / PVC BLACK	-	-	-30°C to +80°C, >7xO.D.	-5°C to +80°C, >15xO.D.	-	-
P03	3 / 4 / 5	0.34mm ²	PUR / PVC BLACK	-	-	-30°C to +80°C, >7xO.D.	-5°C to +80°C, >15xO.D.	-	-

CABLE LENGTH TOLERANCES

OVER	UP TO AND INCLUDING	TOLERANCES
0	305mm	+19mm
305mm	915mm	+45mm
915mm	1830mm	+56mm
1830mm	3660mm	+89mm
3660mm	7320mm	+165mm
7320mm	14640mm	+317mm
14640mm	30500mm	+610mm
30500mm	>	+2% of finished length

THIS DRAWING CONTAINS INFORMATION THAT IS PROPRIETARY TO MOLEX ELECTRONIC TECHNOLOGIES, LLC AND SHOULD NOT BE USED WITHOUT WRITTEN PERMISSION

QUALITY SYMBOLS FA = 0 FE = 0 FB = 0 FC = 0 FD = 0 FE = 0 FF = 0 FG = 0 FH = 0 FI = 0 FJ = 0 FK = 0 FL = 0 FM = 0 FN = 0 FO = 0 FP = 0 FQ = 0 FR = 0 FS = 0 FT = 0 FU = 0 FV = 0 FW = 0 FX = 0 FY = 0 FZ = 0 FA = 0 FB = 0 FC = 0 FD = 0 FE = 0 FF = 0 FG = 0 FH = 0 FI = 0 FJ = 0 FK = 0 FL = 0 FM = 0 FN = 0 FO = 0 FP = 0 FQ = 0 FR = 0 FS = 0 FT = 0 FU = 0 FV = 0 FW = 0 FX = 0 FY = 0 FZ = 0	EC NO: 177711 DRWN: SSM CHK'D: SSM APPR: THAERDT	2017/12/07 2018/06/06 2018/06/06	GENERAL TOLERANCES (UNLESS SPECIFIED) ANGULAR TOL ± 1.0 ° 4 PLACES ± 3 PLACES ± 2 PLACES ± 0.05 1 PLACE ± 0.3 0 PLACES ± 0.5	DIMENSION UNITS: mm SCALE: 1:1 DRWN BY: JMARSZALEK DATE: 2016/10/05 CHK'D BY: DATE: APPR BY: RSILLER DATE: 2016/12/08		
	PRODUCT CUSTOMER DRAWING			DRAFT WHERE APPLICABLE MUST REMAIN WITHIN DIMENSIONS	DRAWING SIZE: A3 THIRD ANGLE PROJECTION	SERIES: 120066 MATERIAL NUMBER: SEE SHEET 3 CUSTOMER: GENERAL MARKET
	RELEASE STATUS: P1 RELEASE DATE: 2018/06/06 10:54:58			DOCUMENT NUMBER: 1200668189 DOC TYPE: PSD DOC PART: 000 SHEET NUMBER: 2 OF 3		

PART LIST

No.	Part No.	Engineering No.	Cable Length
1	1200060056	884031P03M010	1m
2	1200060057	884031P03M020	2m
3	1200070118	883031E03M006	0.6m
4	1200070119	883031E03M010	1m
5	1200070121	883031E03M020	2m
6	1200070123	883031E03M030	3m
7	1200070125	883031E03M050	5m
8	1200070127	883031E03M100	10m
9	1200070140	883031P03M003	0.3m
10	1200070141	883031P03M006	0.6m
11	1200070142	883031P03M010	1m
12	1200070143	883031P03M020	2m
13	1200070144	883031P03M030	3m
14	1200070145	883031P03M050	5m
15	1200070146	883031P03M100	10m
16	1200070507	884031E03M003	0.3m
17	1200070508	884031E03M006	0.6m
18	1200070509	884031E03M010	1m
19	1200070511	884031E03M020	2m
20	1200070512	884031E03M030	3m
21	1200070526	884031P03M003	0.3m
22	1200070527	884031P03M006	0.6m
23	1200070529	884031P03M030	3m
24	1200070904	884031E03M050	5m
25	1200070917	885031P03M020	2m
26	1200070919	885031P03M030	3m
27	1200070945	883031E03M015	1.5m
28	1200071121	883031P03M010H	1m
29	1200071157	884031E03M060	6m
30	1200071187	884031P03M050	5m
31	1200071278	884031E03M100	10m
32	1200072011	884031E03M200	20m
33	1200072012	884031P03M100	10m
34	1200072164	883031E03M040	4m
35	1200072365	884031E03M1501 *	15m

No.	Part No.	Engineering No.	Cable Length
36	1200072376	885031P03M0105	1m
37	1200072445	883031E03M020H	2m
38	1200072575	888031P02M030	3m
39	1200072708	888031P02M060	6m
40	1200073085	885031P03M006	0.6m
41	1200073086	885031P03M100	10m
42	1200658319	888031H08M050	5m
43	1200658762	883031H09M006	0.6m
44	1200658763	883031H09M010	1m
45	1200658764	883031H09M020	2m
46	1200658765	883031H09M030	3m
47	1200658766	883031H09M040	4m
48	1200658767	883031H09M050	5m
49	1200658768	883031H09M100	10m
50	1200658909	888031H08M010	1m
51	1200659035	883031E02M050	5m
52	1200661436	888031P02M100	10m
53	1200661620	888031P02M020	2m
54	1200661626	888031P02M010	1m
55	1200668091	885031P03M025	2.5m
56	1200668175	883031E03M060	6m
57	1200668188	885031P03M010	1m
58	1200668189	885031E03M010	1m
59	1200668190	888031P02M200	20m
60	1200668210	884031H09M009	0.9m
61	1200668212	884031H09M020	2m
62	1200668215	884031H09M030	3m
63	1200668273	885031P03M050	5m
64	1200668278	885031E03M020	2m
65	1200668279	885031E03M050	5m
66	1200668324	883031P03M010G	1m
67	1200668325	883031P03M020G	2m
68	1200668326	883031P03M030G	3m
69	1200668339	885031E03M006	0.6m
70	1200668340	885031E03M030	3m

No.	Part No.	Engineering No.	Cable Length
71	1200668348	885031E03M100	10m
72	1200668361	884031E03M015	1.5m
73	1200668484	884031H09M010	1m
74	1200668488	884031H09M015	1.5m
75	1200668496	885031H09M010	1m
76	1200668512	885031H09M006	0.6m
77	1200668513	885031H09M020	2m
78	1200668514	885031H09M030	3m
79	1200668515	885031H09M050	5m
80	1200668516	885031H09M100	10m
81	1200668520	883031P03M070	7m
82	1200668608	883031E02M020	2m
83	1200668610	885031E02M050	5m
84	1200668612	883031E02M100	10m
85	1200668613	883031E02M030	3m
86	1200668635	883031E03M010Y	1m
87	1200668636	883031E03M020Y	2m
88	1200668653	885031E03M070	7m
89	1200668658	885031E02M020	2m
90	1200668660	885031E02M100	10m
91	1200668669	884031H09M006	0.6m
92	1200668670	884031H09M050	5m
93	1200668671	884031H09M100	10m
94	1200668673	888031E02M0041	0.4m
95	1200668753	883031P03M020H	2m
96	1200668761	885031E03M150	15m
97	1200668845	884031H09M018	1.8m
98	1200668846	884031H09M008	0.8m
99	1200668847	884031H09M021	2.1m
100	1200668848	884031H09M013	1.3m
101	1200668849	888031P02M150	15m
102	1200668908	883031E03M003H	0.3m
103	1200668909	883031E03M006H	0.6m
104	1200668910	883031E03M010H	1m
105	1200668911	883031E03M030H	3m

Pos.	Part No.	Engineering No.	Cable Length
106	1200668912	883031E03M050H	5m
107	1200668967	883031E03M015H	1.5m
108	1200668968	883031E03M040H	4m
109	1200669229	885031H09C250	0.25m
110	1200669260	884031E03M030H	3m
111	1200656208	888031H08C250	0.25m
112	1200656209	888031H08M005	0.5m
113	1200656210	888031H08M008	0.8m
114	1200656211	888031H08M012	1.2m
115	1200656212	888031H08M015	1.5m
116			
117			
118			
119			
120			
121			
122			
123			
124			
125			
126			
127			
128			
129			
130			
131			
132			
133			
134			
135			
136			
137			
138			
139			
140			

NOTES:

* - Part No. with Yellow PVC overmolding

QUALITY SYMBOLS □ = 0 □ = 0 □ = 0 ▼ = 0 □ = 0 □ = 0 □ = 0 □ = 0 □ = 0				THIS DRAWING CONTAINS INFORMATION THAT IS PROPRIETARY TO MOLEX ELECTRONIC TECHNOLOGIES, LLC AND SHOULD NOT BE USED WITHOUT WRITTEN PERMISSION				DIMENSION UNITS SCALE mm 1:1							
EC NO: 177711 DRWN: SSM CHK'D: SSM APPR: THAERDT		2017/12/07 2018/06/06 2018/06/06		GENERAL TOLERANCES (UNLESS SPECIFIED) ANGULAR TOL ± 1.0 ° 4 PLACES ± 3 PLACES ± 2 PLACES ± 0.05 1 PLACE ± 0.3 0 PLACES ± 0.5		DRWN BY DATE JMARSZALEK 2016/10/05		CHK'D BY DATE RSILLER 2016/12/08		PRODUCT CUSTOMER DRAWING SERIES MATERIAL NUMBER CUSTOMER 120066 SEE PART LIST GENERAL MARKET					
DRAFT WHERE APPLICABLE MUST REMAIN WITHIN DIMENSIONS		A3		THIRD ANGLE PROJECTION		DOCUMENT NUMBER 1200668189		DOC TYPE PSD		DOC PART 000		SHEET NUMBER 3 OF 3			