

BLL 7.62HP/03/180LF 3.2SN BK BX
Weidmüller Interfaces GmbH & Co. KG

Postfach 3030

32760 Detmold

Tel. +49 5231 14-0

Fax. +49 5231 14-2083

info@weidmueller.com

www.weidmueller.com

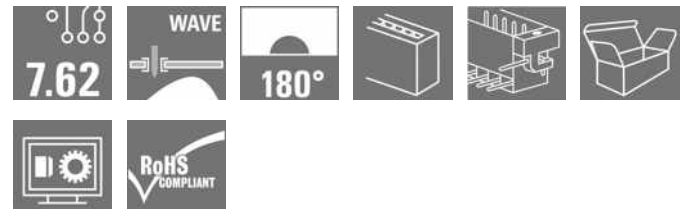
Product image

180° female header for the PCB with a pitch of 7.62. Meets IEC 61800-5-1 requirements and enables UL approval as per UL840 600 V. Ideal touch-safe solution for the power output and intermediate circuit applications. The mating profile guarantees touch safety of >3 mm as per IEC61800-5-1. Variants: without flange, with screw flange or with soldered flange.

General ordering data

Version	PCB plug-in connector, female header, Solder flange, THT solder connection, 7.62 mm, Number of poles: 3, 180°, Solder pin length (l): 3.2 mm, tinned, black, Box
Order No.	1134090000
Type	BLL 7.62HP/03/180LF 3.2SN BK BX
GTIN (EAN)	4032248914074
Qty.	54 pc(s).
Product data	IEC: 630 V / 24 A UL: 300 V / 20 A
Packaging	Box

BLL 7.62HP/03/180LF 3.2SN BK BX

Weidmüller Interfaces GmbH & Co. KG

Postfach 3030

32760 Detmold

Tel. +49 5231 14-0

Fax. +49 5231 14-2083

info@weidmueller.com

www.weidmueller.com

Technical data**Dimensions and weights**

Depth	10.4 mm	Depth (inches)	0.409 inch
Height	27.7 mm	Height (inches)	1.091 inch
Width	32.04 mm	Width (inches)	1.261 inch
Net weight	6.093 g		

Temperatures

Operating temperature, min.	-50 °C	Operating temperature, max.	100 °C
-----------------------------	--------	-----------------------------	--------

System Parameters

Product family	OMNIMATE Power - series BL/SL 7.62HP	Type of connection	Board connection
Pitch in mm (P)	7.62 mm	Pitch in inches (P)	0.3 inch
Number of poles	3	L1 in mm	15.24 mm
L1 in inches	0.6 inch	Number of rows	1
Pin series quantity	1	Touch-safe protection acc. to DIN VDE 57 106	Safe from finger touch
Touch-safe protection acc. to DIN VDE 0470	IP 20	Can be coded	Yes
Plugging force/pole, max.	10 N	Pulling force/pole, max.	7 N

Material data

Insulating material	PA GF	Colour	black
Colour chart (similar)	RAL 9011	Insulating material group	IIIa
Comparative Tracking Index (CTI)	≥ 200	UL 94 flammability rating	V-0
Contact material	Copper alloy	Contact surface	tinned
Layer structure of solder connection	2...3 µm Ni / 2...4 µm Sn matt	Layer structure of plug contact	4...8 µm Sn hot-dip tinned
Storage temperature, min.	-40 °C	Storage temperature, max.	70 °C
Operating temperature, min.	-50 °C	Operating temperature, max.	100 °C
Temperature range, installation, min.	-25 °C	Temperature range, installation, max.	100 °C

Rated data acc. to IEC

tested acc. to standard	IEC 60664-1, IEC 61984	Rated current, min. number of poles (Tu=20°C)	24 A
Rated current, max. number of poles (Tu=20°C)	24 A	Rated current, min. number of poles (Tu=40°C)	24 A
Rated current, max. number of poles (Tu=40°C)	21 A	Rated voltage for surge voltage class / pollution degree II/2	630 V
Rated voltage for surge voltage class / pollution degree III/2	630 V	Rated voltage for surge voltage class / pollution degree III/3	400 V
Rated impulse voltage for surge voltage class/ pollution degree II/2	4 kV	Rated impulse voltage for surge voltage class/ pollution degree III/2	6 kV
Rated impulse voltage for surge voltage class/ contamination degree III/3	6 kV	Short-time withstand current resistance	3 x 1s with 180 A
Clearance, min.	7.2 mm	Creepage distance, min.	7.8 mm

Rated data acc. to CSA

Rated voltage (Use group B / CSA)	300 V	Rated voltage (Use group C / CSA)	150 V
Rated voltage (Use group D / CSA)	300 V	Rated current (Use group B / CSA)	20 A
Rated current (Use group C / CSA)	20 A	Rated current (Use group D / CSA)	10 A

Creation date May 2, 2023 11:04:25 AM CEST

Catalogue status 28.04.2023 / We reserve the right to make technical changes.

BLL 7.62HP/03/180LF 3.2SN BK BX

Weidmüller Interfaces GmbH & Co. KG

Postfach 3030

32760 Detmold

Tel. +49 5231 14-0

Fax. +49 5231 14-2083

info@weidmueller.com

Technical data

Rated data acc. to UL 1059

Institute (cURus)



Certificate No. (cURus) www.weidmueller.com

E60693

Rated voltage (Use group B / UL 1059)	300 V	Rated voltage (Use group C / UL 1059)	100 V
Rated voltage (Use group D / UL 1059)	300 V	Rated current (Use group B / UL 1059)	20 A
Rated current (Use group C / UL 1059)	20 A	Rated current (Use group D / UL 1059)	10 A
Clearance distance, min.	7.2 mm	Creepage distance, min.	7.8 mm
Reference to approval values	Specifications are maximum values, details - see approval certificate.		

Packing

Packaging	Box	VPE length	348 mm
VPE width	138 mm	VPE height	33 mm

Classifications

ETIM 6.0	EC002637	ETIM 7.0	EC002637
ETIM 8.0	EC002637	ECLASS 9.0	27-44-04-02
ECLASS 9.1	27-44-04-02	ECLASS 10.0	27-44-04-02
ECLASS 11.0	27-46-02-01	ECLASS 12.0	27-46-02-01

Important note

IPC conformity Conformity: The products are developed, manufactured and delivered according international recognized standards and norms and comply with the assured properties in the data sheet resp. fulfill decorative properties in accordance with IPC-A-610 "Class 2". Further claims on the products can be evaluated on request.

Notes

- Additional variants on request
- Gold-plated contact surfaces on request
- Spacing between rows: see hole layout
- Rated current related to rated cross-section & min. No. of poles.
- P on drawing = pitch
- Rated data refer only to the component itself. Clearance and creepage distances to other components are to be designed in accordance with the relevant application standards.
- Long term storage of the product with average temperature of 50 °C and average humidity 70%, 36 months

Approvals

Approvals



ROHS	Conform
UL File Number Search	UL Website
Certificate No. (cURus)	E60693

Creation date May 2, 2023 11:04:25 AM CEST

Catalogue status 28.04.2023 / We reserve the right to make technical changes.

BLL 7.62HP/03/180LF 3.2SN BK BX**Weidmüller Interfaces GmbH & Co. KG**

Postfach 3030

32760 Detmold

Tel. +49 5231 14-0

Fax. +49 5231 14-2083

info@weidmueller.comwww.weidmueller.com**Technical data****Downloads**

Approval/Certificate/Document of Conformity	Declaration of the Manufacturer
Engineering Data	CAD data – STEP
Engineering Data	WSCAD
Catalogues	Catalogues in PDF-format
Brochures	FL DRIVES EN MB DEVICE MANUF. EN FL DRIVES DE FL HEATING ELECTR EN FL APPL INVERTER EN FL_BASE_STATION_EN FL ELEVATOR EN FL POWER SUPPLY EN FL 72H SAMPLE SER EN PO OMNIMATE EN PO OMNIMATE EN

BLL 7.62HP/03/180LF 3.2SN BK BX

Weidmüller Interfaces GmbH & Co. KG

Postfach 3030

32760 Detmold

Tel. +49 5231 14-0

Fax. +49 5231 14-2083

Drawings

Product image



Dimensional drawing info@weidmueller.com

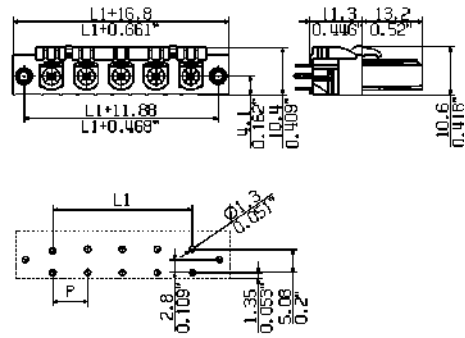

Graph

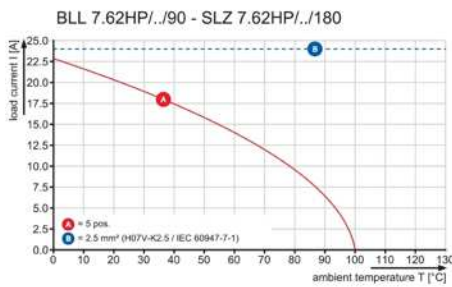

Graph

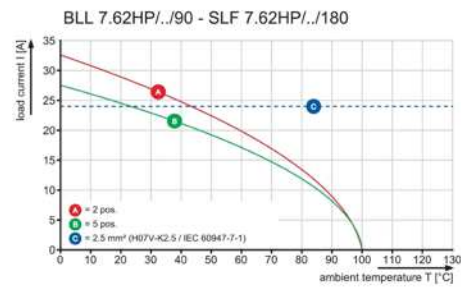

Graph

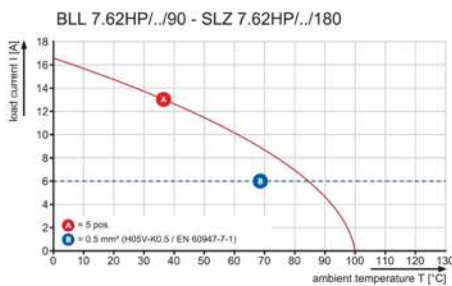

SHOWN: BLL7.62HP/05/180LF 3.2 SN

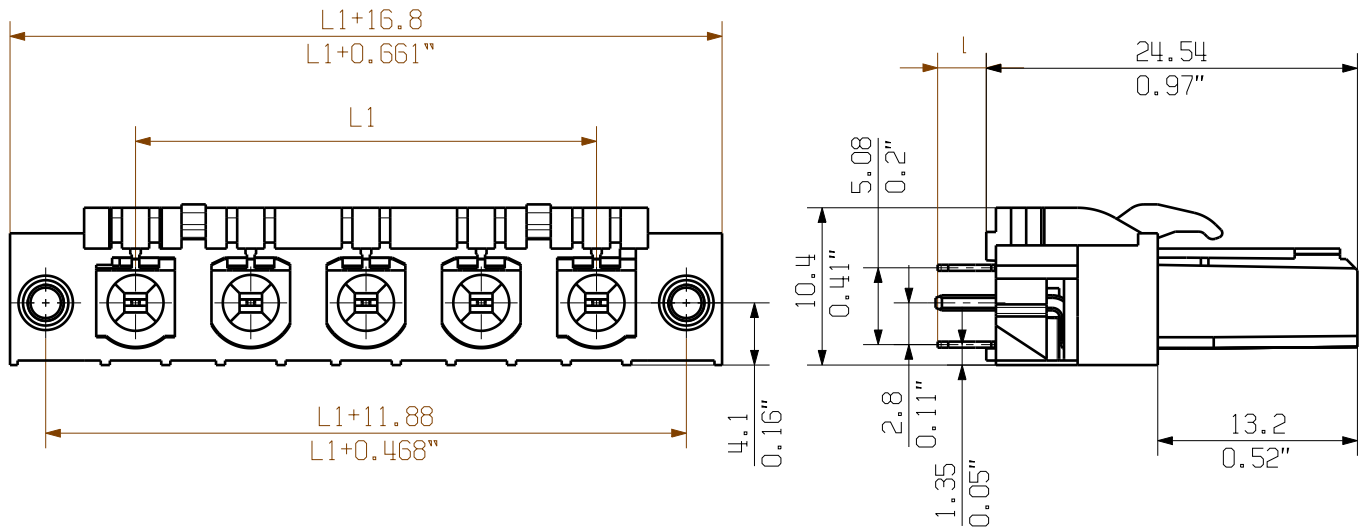

HOLE PATTERN

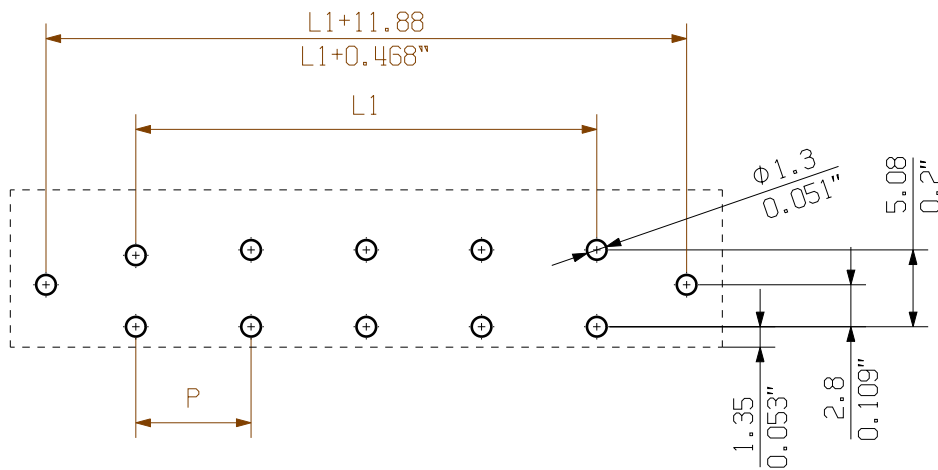

M 1:1

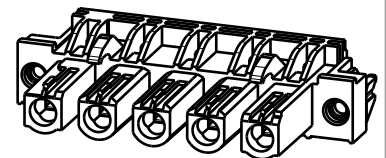

KUNDENZEICHUNG
CUSTOMER DRAWING

For the mounting of PCBs, it should be noted that the rated data relates only to the PCB components alone.
The necessary creepage and clearance paths must be observed in connection with the respective applicant in accordance to IEC 664 / VDE 0110.
The current-carrying capacity and pitch tolerance is to be determined according to DIN IEC 326 part 3 very fine.

Weidmüller PCB components are tested to the DIN EN 61984 standard, and are valid for its field of application. Provided that the components are used to the intended purpose, all requirements with respect to the occurring of electrical, mechanical, thermic and corrosive stress will be satisfied.

3,2
4,5
pin length l

12	83,82	3,30
11	76,20	3,00
10	68,58	2,70
9	60,96	2,40
8	53,34	2,10
7	45,72	1,80
6	38,10	1,50
5	30,48	1,20
4	22,86	0,90
3	15,24	0,60
2	7,62	0,30
n	L1 (mm)	L1 (inch)

The reproduction, distribution and utilization of this document as well as the communication of its contents without explicit authorization is prohibited. Offenders will be held liable for the payment of damages. Weidmüller exclusively reserves the right to file for patents, utility models or designs.

© Weidmüller Interface GmbH & Co. KG

	DIN ISO 2768-m	94360/4 11.05.17 HELIS_MA 00		Cat.no.: .	3 50817 05
	Modification	Date		Name	
	Drawn	21.09.2009	HECKERT_M	Sheet 03 of 03 sheets	BLL 7.62HP/.../180... BUCHSENLEISTE SOCKET BLOCK
Scale: 2:1	Responsible		KRUG_M	Product file: BLL7.62HP	
Supersedes: .	Checked	08.06.2018	HELIS_MA		
	Approved		LANG_T		

Recommended wave soldering profiles

Weidmüller Interface GmbH & Co. KG
 Klingenbergstraße 16
 D-32758 Detmold
 Germany
 Fon: +49 5231 14-0
 Fax: +49 5231 14-292083
 www.weidmueller.com

Single Wave:

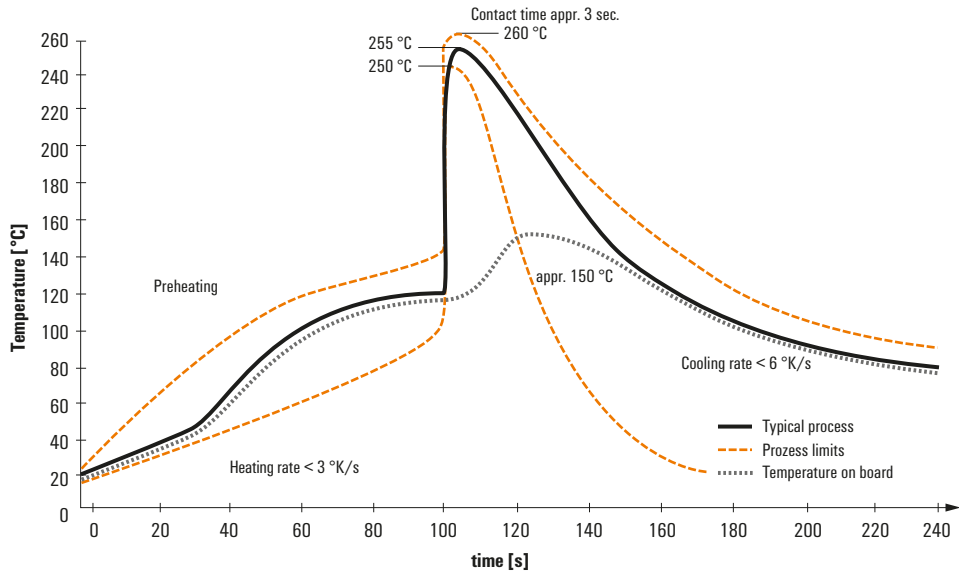

Double Wave:

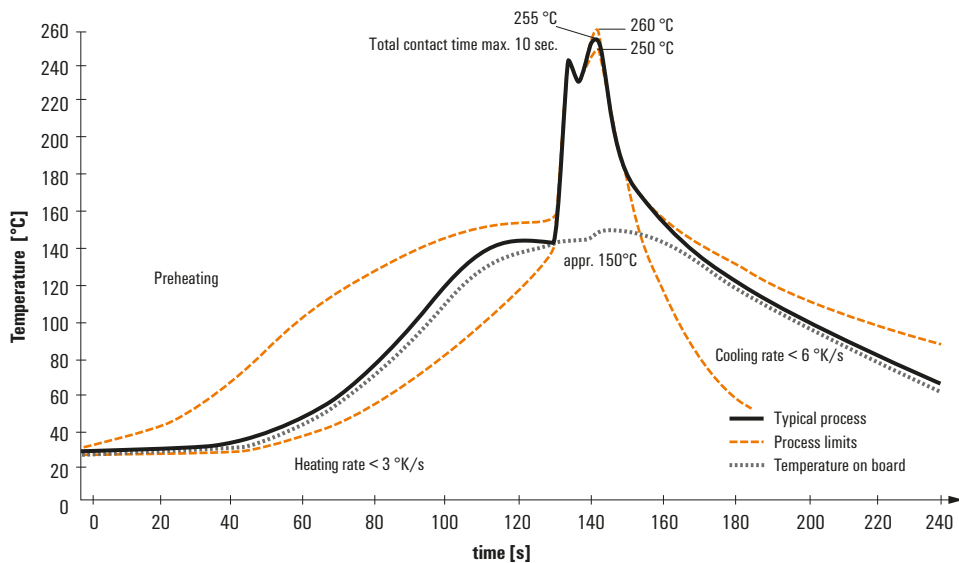

Wave soldering profiles

Wired connection elements should be processed in accordance with the DIN EN 61760-1 standard. We have included two recommendations for practical wave soldering profiles, with which Weidmüller PCB terminals and connectors are qualified.

When choosing a suitable profile for your application, the following factors also need to be considered:

- PCB thickness
- Proportion of Cu in the layers
- Single/double-sided assembly
- Product range
- Heating and cooling rates

The single and double wave profiles each indicate the recommended operating range, including the maximum soldering temperature of 260°C. In practice, the maximum soldering temperature is quite often well below the above maximum profile.