

PLEASE CHECK WWW.MOLEX.COM FOR LATEST PART INFORMATION

Part Number: [1122191047](#)
Status: **Active**
Overview: [Woodhead ArcArrest Connector System](#)
Description: Woodhead ArcArrest 70° Angle Plug, Switch-Rated, 30.0A, 208V AC, 2-Pole+Ground, Insulator Keying Position 16

Documents:

[Drawing \(PDF\)](#)
[Brochure \(PDF\)](#)

[RoHS Certificate of Compliance \(PDF\)](#)

Agency Certification

UL E145923

General

Product Family	Wiring Devices
Series	112219
IP Rating	IP69K
NEMA Configuration	N/A
Overview	Woodhead ArcArrest Connector System
Product Name	ArcArrest
Receptacle Type	N/A
Specialty	Switch-Rated
Type	Plug
UPC	78172559175
Wire Size AWG	8 to 12

Physical

Flange	Yes
Flip Lid	No
Gender	Male
Length	86.60mm (3.410")
Locking Blade	N/A
Poles	2

Electrical

Cord Type	N/A
Current - Maximum per Contact	30.0A
GFCI	No
Lighted Connector	No
Voltage - Maximum	208V AC

Material Info

Engineering Number ARC30MAC02

Reference - Drawing Numbers

Sales Drawing 1122191052-000

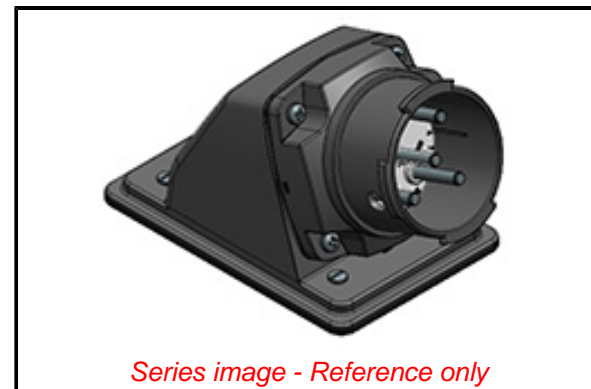

Series image - Reference only

EU ELV

Not Reviewed

EU RoHS

Not Reviewed

REACH SVHC

Not Reviewed

Halogen-Free

Status

Not Reviewed

For more information, please visit [Contact US](#)

China ROHS

Not Reviewed

ELV

Not Reviewed

RoHS Phthalates

Not Reviewed

Search Parts in this Series

[112219 Series](#)