

OMNIMATE Signal - series BL/SL 5.08 BLZP 5.08HC/16/90LR SN BK BX

Weidmüller Interface GmbH & Co. KG
Klingenbergstraße 26
D-32758 Detmold
Germany
Fon: +49 5231 14-0
Fax: +49 5231 14-292083
www.weidmueller.com

Product image

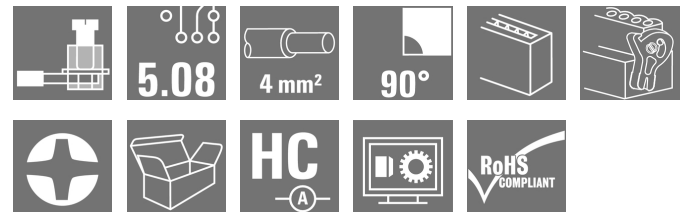

Similar to illustration

Female plugs with clamping-yoke connection for connecting wires with a right-angle (90° or 270°) outlet direction. The female connectors provide space for labelling and can be coded. Fastened by means of a flange or release latch. They also provide an integrated plus/minus screw, protection against faulty insertion of the wire, and they are delivered with open clamping yokes. HC = High Current.

General ordering data

Type	BLZP 5.08HC/16/90LR SN BK BX
Order No.	1068510000
Version	PCB plug-in connector, female plug, 5.08 mm, Number of poles: 16, 90°, Clamping yoke connection, Clamping range, max. : 4 mm², Box
GTIN (EAN)	4032248823055
Qty.	18 pc(s).
Product data	IEC: 400 V / 23 A / 0.2 - 4 mm² UL: 300 V / 20 A / AWG 26 - AWG 12
Packaging	Box

Creation date April 22, 2020 11:53:17 PM CEST

**OMNIMATE Signal - series BL/SL 5.08
BLZP 5.08HC/16/90LR SN BK BX**

Weidmüller Interface GmbH & Co. KG
Klingenbergstraße 26
D-32758 Detmold
Germany
Fon: +49 5231 14-0
Fax: +49 5231 14-292083
www.weidmueller.com

Technical data**Dimensions and weights**

Width	91.1 mm	Width (inches)	3.587 inch
Height	17.7 mm	Height (inches)	0.697 inch
Depth	29.5 mm	Depth (inches)	1.161 inch
Net weight	34.111 g		

System Parameters

Product family	OMNIMATE Signal - series BL/SL 5.08	Type of connection	Field connection
Wire connection method	Clamping yoke connection	Pitch in mm (P)	5.08 mm
Pitch in inches (P)	0.2 inch	Conductor outlet direction	90°
Number of poles	16	L1 in mm	76.2 mm
L1 in inches	3 inch	Number of rows	1
Pin series quantity	1	Rated cross-section	4 mm ²
Touch-safe protection acc. to DIN VDE 57 106	Safe from finger touch	Volume resistance	≤ 5mΩ
Can be coded	Yes	Stripping length	7 mm
Tightening torque, min.	0.4 Nm	Tightening torque, max.	0.5 Nm
Clamping screw	M 2.5	Screwdriver blade	0.6 x 3.5, PH 1, PZ 1
Screwdriver blade standard	DIN 5264, ISO 8764/2-PH, ISO 8764/2-PZ	Plugging cycles	25
Plugging force/pole, max.	10 N	Pulling force/pole, max.	9 N

Material data

Insulating material	PBT	Colour	black
Colour chart (similar)	RAL 9011	Insulating material group	IIIa
Comparative Tracking Index (CTI)	≥ 200	Insulation strength	≥ 10 ⁸ Ω
UL 94 flammability rating	V-0	GWFI	960 °C
Contact material	Copper alloy	Contact surface	tinned
Layer structure of plug contact	4-8 μm Sn hot-dip tinned	Storage temperature, min.	-25 °C
Storage temperature, max.	50 °C	Max. relative humidity during storage	70 %
Operating temperature, min.	-50 °C	Operating temperature, max.	100 °C
Temperature range, installation, min.	-25 °C	Temperature range, installation, max.	100 °C

Conductors suitable for connection

Clamping range, min.	0.13 mm ²	Clamping range, max.	4 mm ²
Wire connection cross section AWG, min.	AWG 30	Wire connection cross section AWG, max.	AWG 12
Solid, min. H05(07) V-U	0.2 mm ²	Solid, max. H05(07) V-U	4 mm ²
Flexible, min. H05(07) V-K	0.2 mm ²	Flexible, max. H05(07) V-K	4 mm ²
w. plastic collar ferrule, DIN 46228 pt 4, min.	0.2 mm ²	w. plastic collar ferrule, DIN 46228 pt 4, max.	2.5 mm ²
w. wire end ferrule, DIN 46228 pt 1, min.	0.2 mm ²	w. wire end ferrule, DIN 46228 pt 1, max.	4 mm ²
Plug gauge in accordance with EN 60999 a x b; ø	2.8 mm x 2.4 mm	Reference text	The outside diameter of the plastic collar should not be larger than the pitch (P). Length of ferrules is to be chosen depending on the product and the rated voltage.
Max. clamping range	4 mm ²		

OMNIMATE Signal - series BL/SL 5.08 BLZP 5.08HC/16/90LR SN BK BX

Weidmüller Interface GmbH & Co. KG
Klingenbergstraße 26
D-32758 Detmold
Germany
Fon: +49 5231 14-0
Fax: +49 5231 14-292083
www.weidmueller.com

Technical data



Rated data acc. to IEC

Rated current, min. number of poles (Tu=20°C)	23 A	Rated current, max. number of poles (Tu=20°C)	18 A
Rated current, min. number of poles (Tu=40°C)	21 A	Rated current, max. number of poles (Tu=40°C)	16 A
Rated voltage for surge voltage class / pollution degree II/2	400 V	Rated voltage for surge voltage class / pollution degree III/2	320 V
Rated voltage for surge voltage class / pollution degree III/3	250 V	Rated impulse voltage for surge voltage class/ pollution degree II/2	4 kV
Rated impulse voltage for surge voltage class/ pollution degree III/2	4 kV	Rated impulse voltage for surge voltage class/ contamination degree III/3	4 kV
Short-time withstand current resistance	3 x 1s with 120 A		

Rated data acc. to CSA

Institute (CSA)		Certificate No. (CSA)	200039-1121690
Rated voltage (Use group B / CSA)	300 V	Rated voltage (Use group C / CSA)	50 V
Rated voltage (Use group D / CSA)	300 V	Rated current (Use group B / CSA)	20 A
Rated current (Use group D / CSA)	20 A	Wire cross-section, AWG, min.	AWG 30
Wire cross-section, AWG, max.	AWG 12	Reference to approval values	Specifications are maximum values, details - see approval certificate.

Rated data acc. to UL 1059

Institute (UR)		Certificate No. (UR)	E60693
Institute (cURus)		Certificate No. (cURus)	E60693
Rated voltage (Use group B / UL 1059)	300 V	Rated voltage (Use group D / UL 1059)	300 V
Rated current (Use group B / UL 1059)	20 A	Rated current (Use group D / UL 1059)	10 A
Wire cross-section, AWG, min.	AWG 26	Wire cross-section, AWG, max.	AWG 12
Reference to approval values	Specifications are maximum values, details - see approval certificate.		

Packing

Packaging	Box	VPE length	30 mm
VPE width	135 mm	VPE height	350 mm

Classifications

ETIM 6.0	EC002638	ETIM 7.0	EC002638
eClass 9.0	27-44-03-09	eClass 9.1	27-44-03-09
eClass 10.0	27-44-03-09		

Data sheet

**OMNIMATE Signal - series BL/SL 5.08
BLZP 5.08HC/16/90LR SN BK BX**

Weidmüller Interface GmbH & Co. KG
Klingenbergstraße 26
D-32758 Detmold
Germany
Fon: +49 5231 14-0
Fax: +49 5231 14-292083
www.weidmueller.com

Technical data

Notes

Notes	<ul style="list-style-type: none"> • Additional colours on request • Gold-plated contact surfaces on request • Rated current related to rated cross-section & min. No. of poles. • Wire end ferrule without plastic collar to DIN 46228/1 • Wire end ferrule with plastic collar to DIN 46228/4 • P on drawing = pitch • Rated data refer only to the component itself. Clearance and creepage distances to other components are to be designed in accordance with the relevant application standards.
-------	---

IPC conformity	Conformity: The products are developed, manufactured and delivered according international recognized standards and norms and comply with the assured properties in the data sheet resp. fulfill decorative properties in accordance with IPC-A-610 "Class 2". Further claims on the products can be evaluated on request.
----------------	--

Approvals

Approvals



ROHS	Conform
------	---------

Downloads

Approval/Certificate/Document of Conformity	Declaration of the Manufacturer
Brochure/Catalogue	FL DRIVES EN MB DEVICE MANUF. EN FL DRIVES DE CAT 2 PORTFOLIOGUIDE EN FL BUILDING SAFETY EN FL APPL LED LIGHTING EN FLIndustr.CONTROLS EN FL MACHINE SAFETY EN FL HEATING ELECTER EN FL APPL INVERTER EN FL_BASE_STATION_EN FL ELEVATOR EN FL POWER SUPPLY EN PO OMNIMATE EN
Engineering Data	WSCAD
Engineering Data	STEP

**OMNIMATE Signal - series BL/SL 5.08
BLZP 5.08HC/16/90LR SN BK BX**

Weidmüller Interface GmbH & Co. KG
Klingenbergstraße 26
D-32758 Detmold
Germany
Fon: +49 5231 14-0
Fax: +49 5231 14-292083
www.weidmueller.com

Drawings

Dimensional drawing

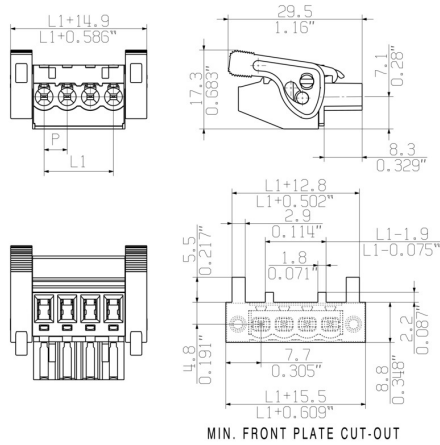

Product benefits

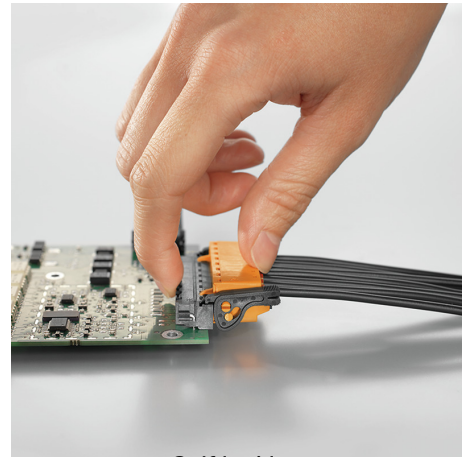

Self-locking
Immediately on plugging in

Product benefits

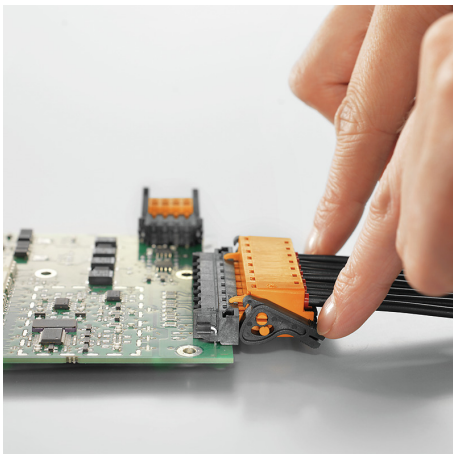

Gentle unlocking
Low mechanical stress

The reproduction, distribution and utilization of this document as well as the communication of its contents to others without explicit authorization is prohibited. Offenders will be held liable for the payment of damages. Weidmüller exclusively reserves the right to file for patents, utility models or designs.

© Weidmüller Interface GmbH & Co. KG

shown:
BLZP 5.08HC/04/90(LR)/(LH)

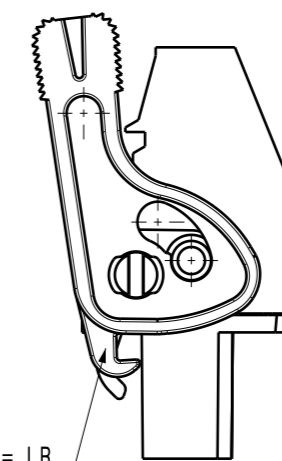
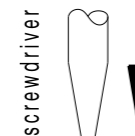
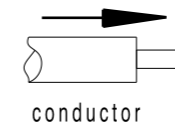
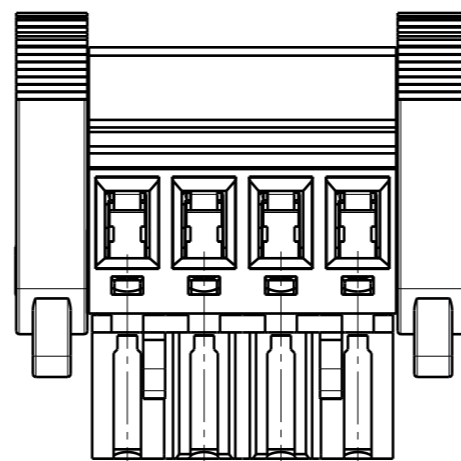

with snap latch = separation latch = LR
without snap latch = separation lever = LH

shown:
BLZP 5.08HC/04/270(LR)/(LH)

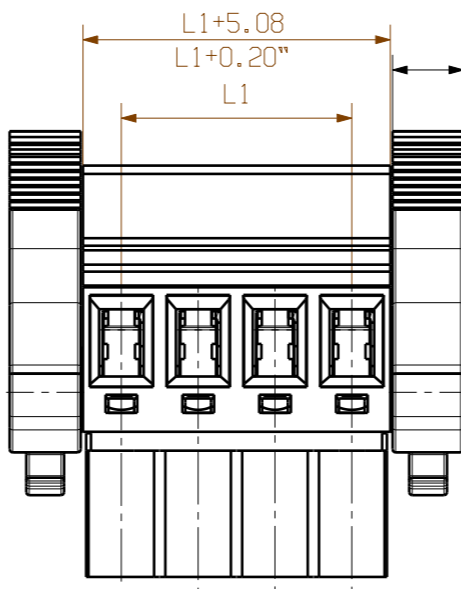

4.7
0.185"

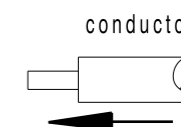
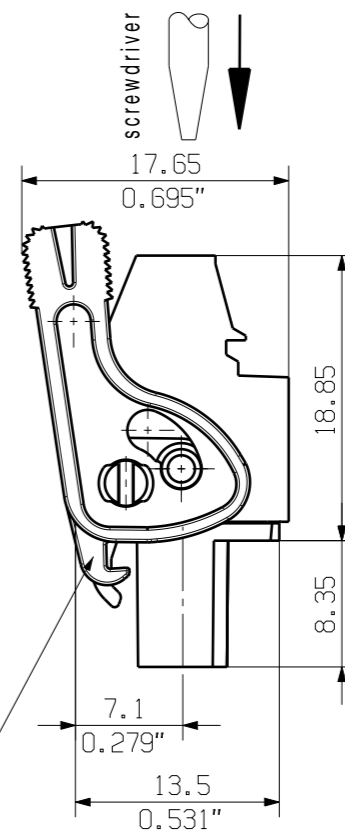

with snap latch = separation latch = LR
without snap latch = separation lever = LH

P = 5.08 Raster/pitch
n = Polzahl/no of poles#

24	116,84	4,60
23	111,76	4,40
22	106,68	4,20
21	101,60	4,00
20	96,52	3,80
19	91,44	3,60
18	86,36	3,40
17	81,28	3,20
16	76,20	3,00
15	71,12	2,80
14	66,04	2,60
13	60,96	2,40
12	55,88	2,20
11	50,80	2,00
10	45,72	1,80
9	40,64	1,60
8	35,56	1,40
7	30,48	1,20
6	25,40	1,00
5	20,32	0,80
4	15,24	0,60
3	10,16	0,40
2	5,08	0,20
n	L1 [mm]	L1 [inch]

For the mounting of PCBs, it should be noted that the rated data given in the catalogue relates only to the connection elements. The necessary creepage and clearance paths must be observed in connection with the respective applicant in accordance to VDE 0110. The current-carrying capacity and pitch tolerance is to be determined according to DIN IEC 326 part 3 very fine.

Weidmüller connectors are tested to the DIN VDE 0627 standard, and are valid for its field of application. Provided that the connectors are used to the intended purpose, all requirements with respect to the occurring of electrical, mechanical, thermic and corrosive stress will be satisfied.

General tolerance: DIN ISO 2768-mK		89239/5 01.08.16 HELIS_MA 02		Cat.no.: .	
		Modification			
		Drawing no. 3 39786 Issue no. 12 Sheet 03 of 03 sheets			
Drawn 10.06.2013 HERTEL_S Responsible HERTEL_S Checked 08.08.2016 HELIS_MA Approved LANG_T		BLZP 5.08HC/.../.../... .. BUCHSENLEISTE SOCKET BLOCK			
Scale: 2:1		Product file: BLZP 5.08HC		7159	