

PLEASE CHECK WWW.MOLEX.COM FOR LATEST PART INFORMATION

Part Number: [1054302107](#)
Status: **Active**
Overview: [Nano-Fit Power Connectors](#)
Description: Nano-Fit Right-Angle Header, Surface Mount, 2.50mm Pitch, Single Row, 7 Circuits, 0.76µm Tin (Sn) Plating, Natural, Glow-Wire Capable

Documents:

3D Model	Product Specification PS-105405-001-001 (PDF)
Drawing (PDF)	Application Specification AS-105405-001-001 (PDF)
3D Model (PDF)	Packaging Specification 1054301000-PK-000 (PDF)
Product Specification 1054051000-PS-CH-000 (PDF)	Test Summary 1054050000-TS-000 (PDF)
Product Specification 1054051000-PS-ES-000 (PDF)	Datasheet (PDF)
Product Specification 1054051000-PS-SK-000 (PDF)	RoHS Certificate of Compliance (PDF)

General

Product Family	PCB Headers
Series	105430
Application	Power, Wire-to-Board
Overview	Nano-Fit Power Connectors
Product Name	Nano-Fit
UPC	191128933148

Physical

Breakaway	No
Circuits (Loaded)	7
Circuits (maximum)	7
Color - Resin	Natural
Durability (mating cycles max)	25
Glow-Wire Capable	Yes
Keying to Mating Part	Yes
Lock to Mating Part	Yes
Material - Metal	Brass
Material - Plating Mating	Tin
Material - Plating Termination	Tin
Material - Resin	Liquid Crystal Polymer
Net Weight	1.150/g
Number of Rows	1
Orientation	Right Angle
PCB Locator	No
PCB Thickness - Recommended	1.60mm
Packaging Type	Embossed Tape on Reel
Pitch - Mating Interface	2.50mm
Pitch - Termination Interface	2.50mm
Plating min - Mating	0.762µm
Plating min - Termination	0.762µm
Polarized to Mating Part	Yes
Polarized to PCB	No
Temperature Range - Operating	-40° to +105°C
Termination Interface: Style	Surface Mount

Electrical

Current - Maximum per Contact	6.5A
Voltage - Maximum	250V AC (RMS)/DC

Material Info

Reference - Drawing Numbers

Application Specification	AS-105405-001-001
---------------------------	-------------------

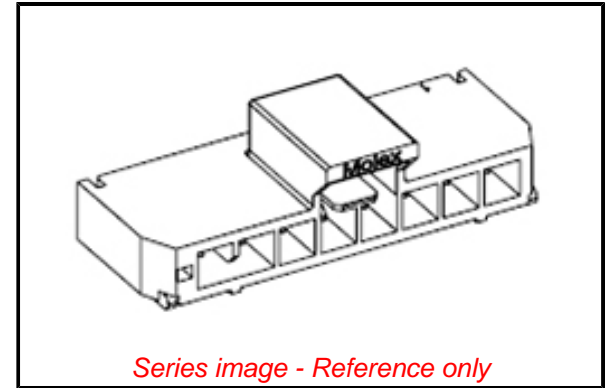

Series image - Reference only

EU ELV

Not Relevant

EU RoHS

Compliant

REACH SVHC

Not Contained Per -
D(2020)4578-DC (25
June 2020)

Halogen-Free

Status

Low-Halogen

For more information, please visit [Contact US](#)

China ROHS

ELV

RoHS Phthalates

China RoHS

Green Image

Not Relevant

Not Contained

Search Parts in this Series

[105430 Series](#)

Mates With

Nano-Fit Receptacle Housing [1053072207](#)

Packaging Specification
Product Specification

Sales Drawing
Test Summary

1054301000-PK-000
1054051000-PS-CH-000, 1054051000-PS-ES-000,
1054051000-PS-SK-000, PS-105405-001-001
SD-105430-001-000
1054050000-TS-000

This document was generated on 09/23/2020

PLEASE CHECK WWW.MOLEX.COM FOR LATEST PART INFORMATION