

**PLEASE CHECK WWW.MOLEX.COM FOR LATEST PART INFORMATION**

**Part Number:** [1054301308](#)  
**Status:** **Active**  
**Overview:** [Nano-Fit Power Connectors](#)  
**Description:** Nano-Fit Right-Angle Header, Surface Mount, 2.50mm Pitch, Single Row, 8 Circuits, 0.76µm Gold (Au) Plating, Black, Glow-Wire Capable

**Documents:**

<a href="#">3D Model</a>	<a href="#">Product Specification PS-105405-001-001 (PDF)</a>
<a href="#">3D Model (PDF)</a>	<a href="#">Application Specification AS-105405-001-001 (PDF)</a>
<a href="#">Drawing (PDF)</a>	<a href="#">Packaging Specification 1054301000-PK-000 (PDF)</a>
<a href="#">Product Specification 1054051000-PS-CH-000 (PDF)</a>	<a href="#">Test Summary 1054050000-TS-000 (PDF)</a>
<a href="#">Product Specification 1054051000-PS-ES-000 (PDF)</a>	<a href="#">Datasheet (PDF)</a>
<a href="#">Product Specification 1054051000-PS-SK-000 (PDF)</a>	<a href="#">RoHS Certificate of Compliance (PDF)</a>

**General**

Product Family	PCB Headers
Series	<a href="#">105430</a>
Application	Power, Wire-to-Board
Overview	<a href="#">Nano-Fit Power Connectors</a>
Product Name	Nano-Fit
UPC	191128932196

**Physical**

Breakaway	No
Circuits (Loaded)	8
Circuits (maximum)	8
Color - Resin	Black
Durability (mating cycles max)	50
Glow-Wire Capable	Yes
Keying to Mating Part	Yes
Lock to Mating Part	Yes
Material - Metal	Brass
Material - Plating Mating	Gold
Material - Plating Termination	Tin
Material - Resin	Liquid Crystal Polymer
Net Weight	1.260/g
Number of Rows	1
Orientation	Right Angle
PCB Locator	No
PCB Thickness - Recommended	1.60mm
Packaging Type	Embossed Tape on Reel
Pitch - Mating Interface	2.50mm
Pitch - Termination Interface	2.50mm
Plating min - Mating	0.762µm
Plating min - Termination	0.762µm
Polarized to Mating Part	Yes
Polarized to PCB	No
Temperature Range - Operating	-40° to +115°C
Termination Interface: Style	Surface Mount

**Electrical**

Current - Maximum per Contact	6.5A
Voltage - Maximum	250V AC (RMS)/DC

**Material Info**

**Reference - Drawing Numbers**

Application Specification	AS-105405-001-001
---------------------------	-------------------

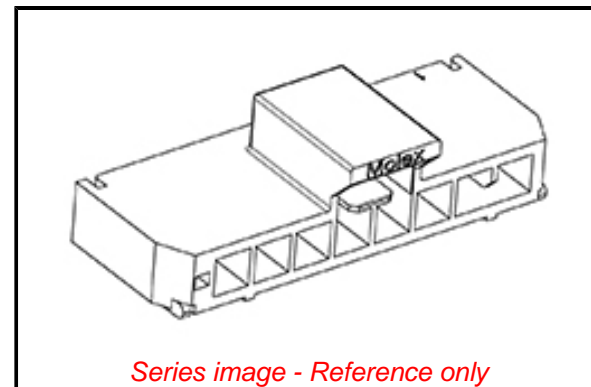

*Series image - Reference only*

**EU ELV**

**Not Relevant**

**EU RoHS**

**Compliant**

**REACH SVHC**

Not Contained Per -  
D(2020)4578-DC (25  
June 2020)

**Halogen-Free**

**Status**

**Low-Halogen**

For more information, please visit [Contact US](#)

China ROHS

ELV

RoHS Phthalates

**China RoHS**

Green Image

Not Relevant

Not Contained

**Search Parts in this Series**

[105430 Series](#)

**Mates With**

Nano-Fit Receptacle Housing [1053071208](#)

Packaging Specification  
Product Specification

Sales Drawing  
Test Summary

1054301000-PK-000  
1054051000-PS-CH-000, 1054051000-PS-ES-000,  
1054051000-PS-SK-000, PS-105405-001-001  
SD-105430-001-000  
1054050000-TS-000

This document was generated on 09/22/2020

**PLEASE CHECK [WWW.MOLEX.COM](http://WWW.MOLEX.COM) FOR LATEST PART INFORMATION**