

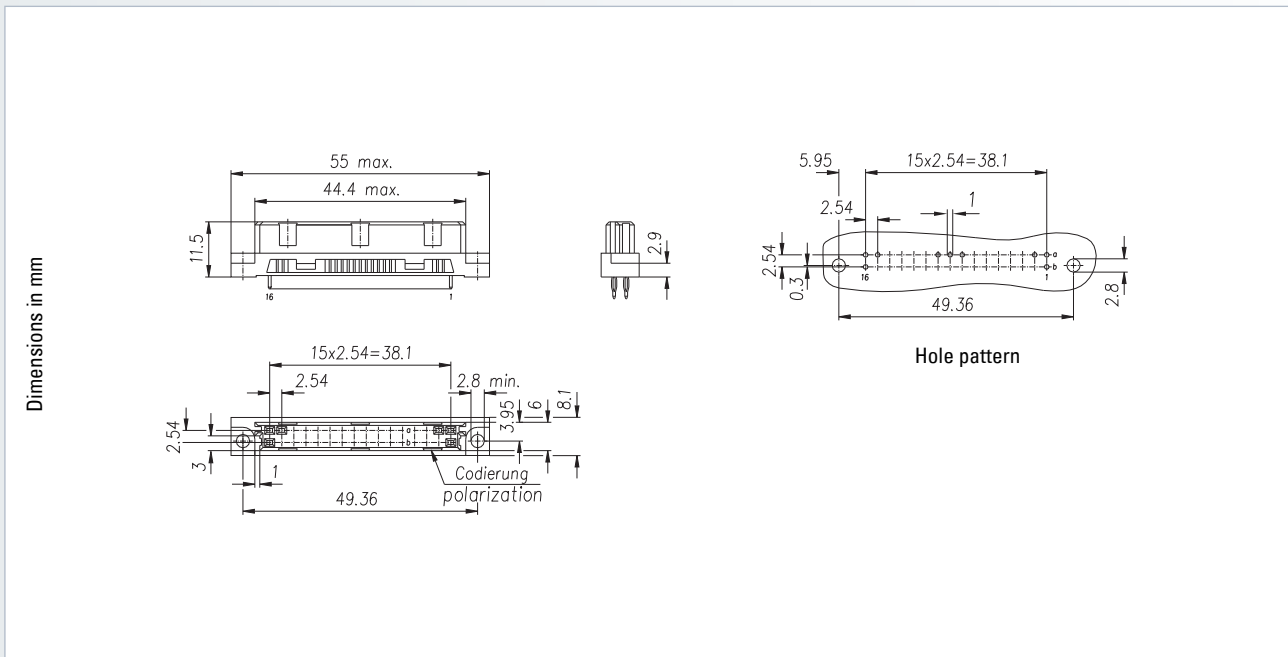

Connectors according to DIN 41612 / IEC 60603-2

Type B/2



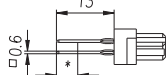
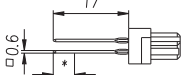
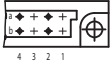
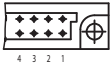

Female connector

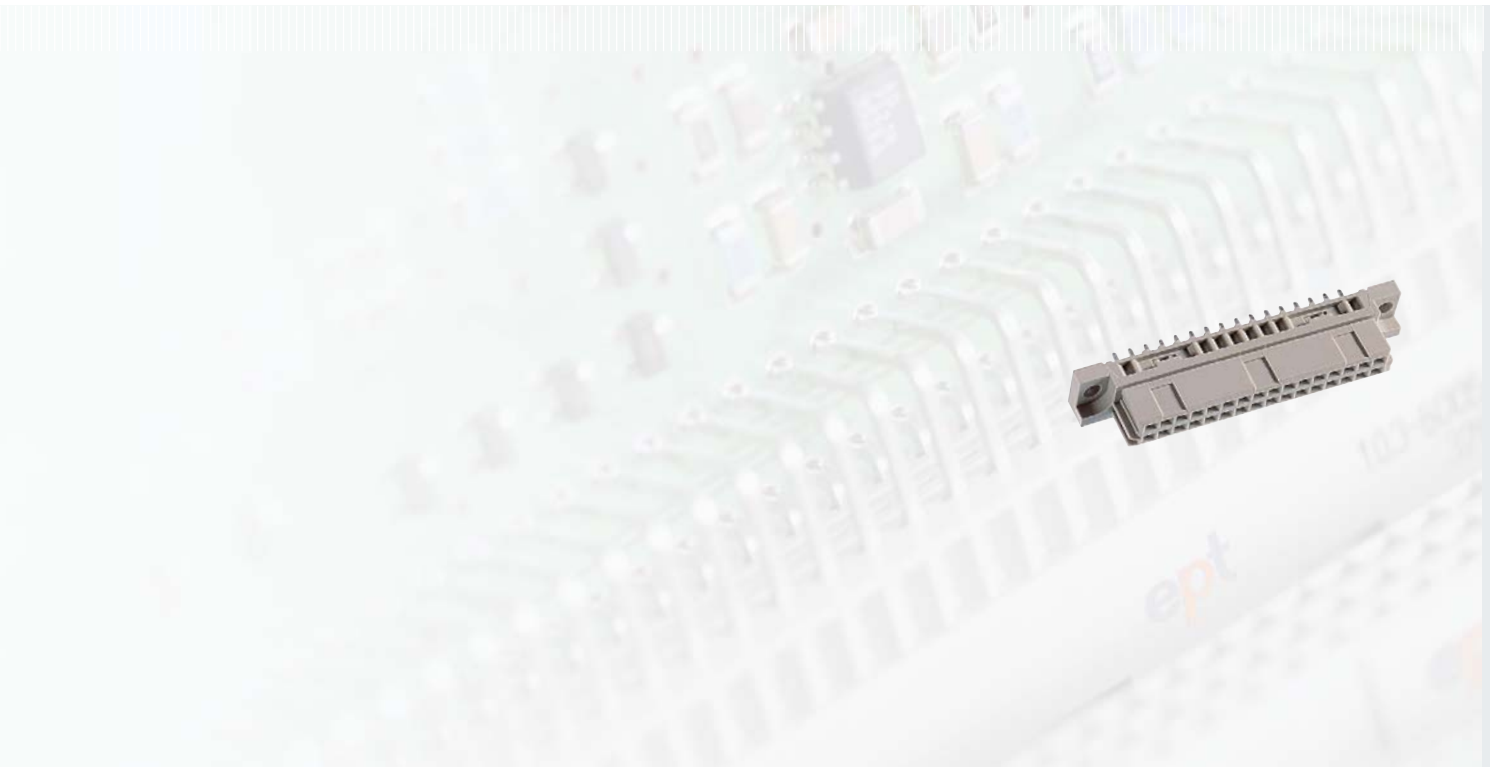

No. of contacts	Contact arrangement	Press-fit technology – Performance level II		
		Termination length		
				
Part number				
16		102-69004-xx	102-79006-xx	102-79106-xx
32		102-69064-xx	102-79066-xx	102-79166-xx

<p>Accessories</p> <ul style="list-style-type: none"> – Press-fit tool (see page 208) – Support tool (see page 209) – Coding accessories (see page 160) 	<p>On request</p> <ul style="list-style-type: none"> – Performance levels I + III or customer-specific – Special contact length – Alternative surface Sn, e.g. for WireWrap 	<p>Options</p> <ul style="list-style-type: none"> – Without flange – Contact arrangement (see page 162)
<p>Note</p> <ul style="list-style-type: none"> – * Rear mating zone performance level II 	<p>Ordering note</p> <ul style="list-style-type: none"> – PCB 1.5 to 2.0 mm = xxx-xxxx-01 with termination length = 3.2 mm – PCB 2.0 to 2.8 mm = xxx-xxxx-02 with termination length = 4.6 mm – PCB > 2.8 mm = xxx-xxxx-03 with termination length = 4.6 mm 	

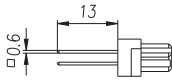
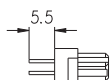
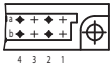

No. of contacts	Contact arrangement	Solder technology – Performance level II			
		Termination length			
					Manual soldering with solder lug 
Part number					
16		102-90004	102-90005	102-90006	102-90025
32		102-90064	102-90065	102-90066	102-90075

Accessories – Coding accessories (see page 160)	On request – Performance levels I + III or customer-specific – Also in THTR	Options – Board lock (see page 159) – Contact arrangement (see page 162)
---	--	---