

PCB terminal block - TDPT 2,5/ 8-SP-5,08



1017509

<https://www.phoenixcontact.com/pc/products/1017509>

Please be informed that the data shown in this PDF document is generated from our Online Catalog. Please find the complete data in the user documentation. Our General Terms of Use for Downloads are valid.

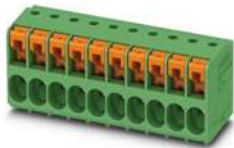

PCB terminal block, nominal current: 32 A, rated voltage (III/2): 400 V, nominal cross section: 2.5 mm², number of potentials: 8, number of rows: 1, number of positions per row: 8, product range: TDPT 2,5/..-SP, pitch: 5.08 mm, connection method: Push-in spring connection, mounting: Wave soldering, conductor/PCB connection direction: 0 °, color: green, Pin layout: Linear pinning, Solder pin [P]: 3.5 mm, number of solder pins per potential: 2, type of packaging: packed in cardboard

Your advantages

- Easy to adapt, thanks to their identical size and the same pinning for Push-in spring connections as for screw connections
- Time saving push-in connection, tools not required
- Defined contact force ensures that contact remains stable over the long term
- Intuitive use through colour coded actuation lever

Commercial Data

Item number	1017509
Packing unit	50 pc
Minimum order quantity	1 pc
Product Key	AAMBGA
GTIN	4055626501437
Weight per Piece (including packing)	16.45 g
Weight per Piece (excluding packing)	16.45 g
Customs tariff number	85369010
Country of origin	CN

1017509

<https://www.phoenixcontact.com/pc/products/1017509>

Technical Data

Product properties

Product line	COMBICON Terminals M
Product type	Printed circuit board terminal
Number of positions	8
Pitch	5.08 mm
Number of connections	8
Number of rows	1
Number of potentials	8
Pin layout	Linear pinning
Solder pins per potential	2

Electrical properties

Nominal current I_N	32 A
Nominal voltage U_N	400 V
Degree of pollution	3
Rated voltage (III/3)	320 V
Rated surge voltage (III/3)	4 kV
Rated voltage (III/2)	400 V
Rated surge voltage (III/2)	4 kV

Connection data

Connection technology

Nominal cross section	2.5 mm ²
-----------------------	---------------------

Conductor connection

Connection method	Push-in spring connection
Conductor cross section solid	0.2 mm ² ... 4 mm ² (Conductor connection with open terminal point)
	0.75 mm ² ... 4 mm ² (Push-in connection)
Conductor cross section flexible	0.2 mm ² ... 4 mm ²
Conductor cross section AWG	24 ... 12
Conductor cross section flexible, with ferrule without plastic sleeve	0.2 mm ² ... 2.5 mm ²
Conductor cross section, flexible, with ferrule, with plastic sleeve	0.2 mm ² ... 2.5 mm ²
2 conductors with the same cross section, flexible, with TWIN ferrule with plastic sleeve	0.5 mm ² ... 0.75 mm ²
Stripping length	10 mm

Mounting

Mounting type	Wave soldering
Pin layout	Linear pinning

Processing notes

PCB terminal block - TDPT 2,5/ 8-SP-5,08

1017509

<https://www.phoenixcontact.com/pc/products/1017509>

Process	Wave soldering
---------	----------------

Material specifications

Material data - contact

Note	WEEE/RoHS-compliant, free of whiskers according to IEC 60068-2-82/JEDEC JESD 201
Contact material	Cu alloy
Surface characteristics	Tin-plated
Metal surface terminal point (top layer)	Tin (10 - 16 µm Sn)
Metal surface soldering area (top layer)	Tin (10 - 16 µm Sn)

Material data - housing

Housing color	green (RAL 6021)
Insulating material	PA
Insulating material group	I
CTI according to IEC 60112	600
Flammability rating according to UL 94	V0
Glow wire flammability index GWFI according to EN 60695-2-12	850
Glow wire ignition temperature GWIT according to EN 60695-2-13	775
Temperature for the ball pressure test according to EN 60695-10-2	125 °C

Material data – actuating element

Colour actuating element	orange (RAL 2003)
Insulating material	PA
Insulating material group	I
CTI according to IEC 60112	600
Flammability rating according to UL 94	V0
Glow wire flammability index GWFI according to EN 60695-2-12	850
Glow wire ignition temperature GWIT according to EN 60695-2-13	775
Temperature for the ball pressure test according to EN 60695-10-2	125 °C

Dimensions

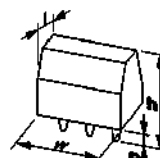
Dimensional drawing	
Pitch	5.08 mm
Width [w]	41.44 mm
Height [h]	22.5 mm
Length [l]	18 mm

PCB terminal block - TDPT 2,5/ 8-SP-5,08



1017509

<https://www.phoenixcontact.com/pc/products/1017509>

Installed height	19 mm
Solder pin length [P]	3.5 mm

PCB design

Pin spacing	8.7 mm
-------------	--------

Electrical tests

Air clearances and creepage distances |

Specification	IEC 60947-1:2007-06 + A1:2010-12 + A2:2014-09
Insulating material group	I
Comparative tracking index (IEC 60112)	CTI 600
Rated insulation voltage (III/3)	320 V
Rated surge voltage (III/3)	4 kV
minimum clearance value - non-homogenous field (III/3)	3 mm
minimum creepage distance (III/3)	4 mm
Rated insulation voltage (III/2)	400 V
Rated surge voltage (III/2)	4 kV
minimum clearance value - non-homogenous field (III/2)	3 mm
minimum creepage distance (III/2)	3 mm
Rated insulation voltage (II/2)	630 V
Rated surge voltage (II/2)	4 kV
minimum clearance value - non-homogenous field (II/2)	3 mm
minimum creepage distance (II/2)	3.2 mm

Environmental and real-life conditions

Ambient conditions

Ambient temperature (operation)	-40 °C ... 105 °C (Depending on the current carrying capacity/derating curve)
Ambient temperature (storage/transport)	-40 °C ... 70 °C
Relative humidity (storage/transport)	30 % ... 70 %
Ambient temperature (assembly)	-5 °C ... 105 °C

Packaging specifications

Type of packaging	packed in cardboard
-------------------	---------------------

PCB terminal block - TDPT 2,5/ 8-SP-5,08



1017509

<https://www.phoenixcontact.com/pc/products/1017509>

Approvals



IECEE CB Scheme

Approval ID: DE1-61270



cULus Recognized

Approval ID: E60425-20180122

	Nominal Voltage U_N	Nominal Current I_N	Cross Section AWG	Cross Section mm^2
Use group B				
	300 V	20 A	24 - 12	-
Use group C				
	150 V	20 A	24 - 12	-
Use group D				
	300 V	10 A	24 - 12	-



EAC

Approval ID: B.01687



VDE Zeichengenehmigung

Approval ID: 40049168

	Nominal Voltage U_N	Nominal Current I_N	Cross Section AWG	Cross Section mm^2
	400 V	32 A	-	0.2 - 4

PCB terminal block - TDPT 2,5/ 8-SP-5,08



1017509

<https://www.phoenixcontact.com/pc/products/1017509>

Classifications

ECLASS

ECLASS-9.0	27440401
ECLASS-10.0.1	27440401
ECLASS-11.0	27460101

ETIM

ETIM 8.0	EC002643
----------	----------

UNSPSC

UNSPSC 21.0	39121400
-------------	----------

PCB terminal block - TDPT 2,5/ 8-SP-5,08



1017509

<https://www.phoenixcontact.com/pc/products/1017509>

Environmental Product Compliance

China RoHS	Environmentally friendly use period: unlimited = EFUP-e
	No hazardous substances above threshold values

PCB terminal block - TDPT 2,5/ 8-SP-5,08



1017509

<https://www.phoenixcontact.com/pc/products/1017509>

Accessories

Screwdriver

Screwdriver - SZF 2-0,8X4,0 - 1204520

<https://www.phoenixcontact.com/pc/products/1204520>



Actuation tool, for ST terminal blocks, also suitable for use as a bladed screwdriver, size: 0.8 x 4.0 x 100 mm, 2-component grip, with non-slip grip

Phoenix Contact 2022 © - all rights reserved
<https://www.phoenixcontact.com>

PHOENIX CONTACT GmbH & Co. KG
Flachsmarktstraße 8
D-32825 Blomberg
+49 (0) 5235-3 00
info@phoenixcontact.com