

10104109-0001LF - MICRO
USB : B TYPE PLUG



ACTIVE



www.fci.com

Mating Half

- ▶ 10103592-0001LF
- ▶ 10103593-0001LF
- ▶ 10103594-0001LF
- ▶ 10104110-0001LF
- ▶ 10104111-0001LF

Specifications

General	
Number of contacts	5
Product Type	Plug
Style	B Type
Series Number	10104109
Single or Dual Stack	Single
Electrical	
Current rating	1.8A per contact
Resistance (Contact)	After test delta: 10 m-ohms Max. change Initial: 30 m-ohms Max.
Resistance (Insulation)	After test: 100 M-ohms Min. Initial: 1000 M-ohms Min.
Voltage rating	100V AC
Mechanical	
Durability (Mating cycles)	10000 Cycles
Insertion force	35N max.
Extraction force (Signal)	8N min.
Mounting	
Mounting style	Surface Mount Type
Physical	
Color (Housing)	Black
Material (Housing)	PA6T, UL 94V-0
Plating (Contact area)	30u" Gold over 50u" Nickel
Plating (Shield)	50u" Ni

Plating (Solder area)

Gold Flash

Other Features

Packaging (Options)

Tray

Part Number
10104109-0001LF

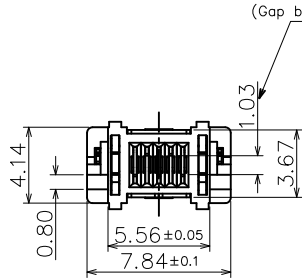

(Gap between Pin, PCB Thickness)

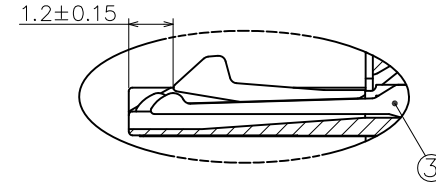
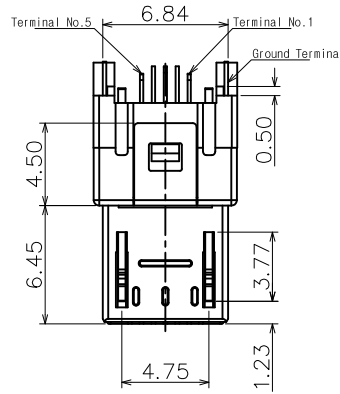
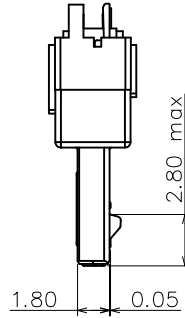
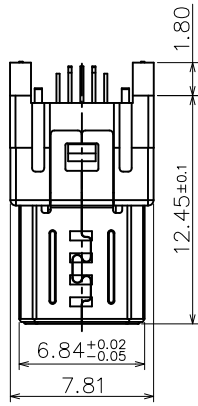
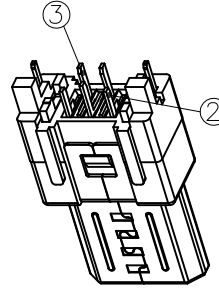
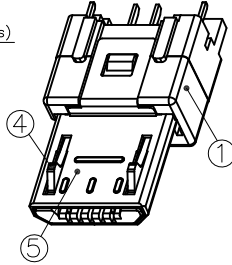

Plug Contact -A Point -2EA (No.2, No.4)
Plug Contact -B Point -1EA (No.3)

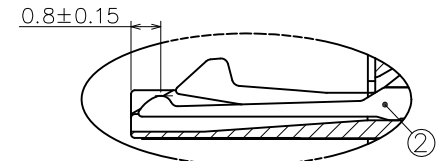

Plug Contact -B Point -2EA (No.1, No.5)

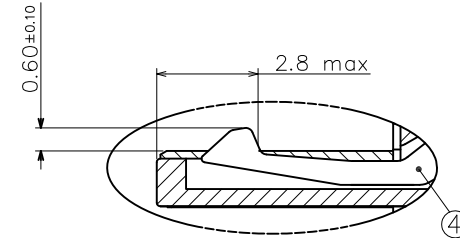

Plug Contact -LOCK TML' Point -2EA

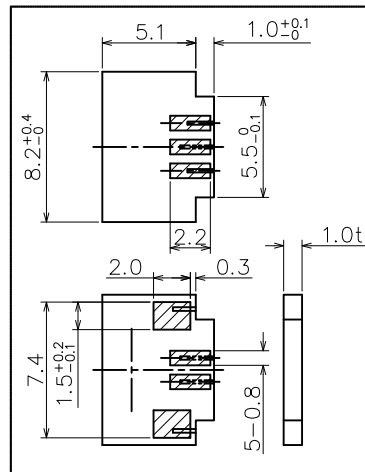
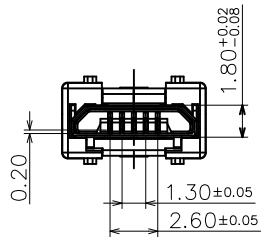

*PCB ref.
(Tolerance ±0.05)

-Note-

1. Material & finish: See table-1
2. Packing in tray

(Table-1)

No.	Part Name	Material	Finish	Remarks
1	Plug Housing	Thermoplastic	black	
2	Plug Contact -B	Copper alloy	Selective Gold Plated	
3	Plug Contact -A	Copper alloy	Selective Gold Plated	
4	Lock Plate	Sustainess steel		
5	Plug Shield	Sustainess steel	Ni Plated	

mat'l. code				tolerances unless otherwise specified		CUSTOMER COPY		 www.fciconnect.com	
ltr	ecn no	dr	date	linear	.X ± 0.38	projection		title	
A	T10-0002	J.H	01/07/10		.XX ± 0.25			MICRO-USB B-TYPE PLUG	
					.XXX ± 0.10				
				angles	0° ±2°	 MM	 scale	product family	code
				dr	JASON HSU 01/07/10			USB	TWN
				enr	JASON HSU 01/07/10			size	dwg no
				chr	GARY HSIEH 01/07/10			A4	10104109
				appd	JOSEPH HSIA 01/07/10	1:1		sheet	1 of 1
sheet index	revision sheet	A	1						