

## SL-SMT 3.50/18/135F 3.2SN BK BX

**Weidmüller Interface GmbH & Co. KG**  
Klingenbergstraße 26  
D-32758 Detmold  
Germany

www.weidmueller.com

### Product image

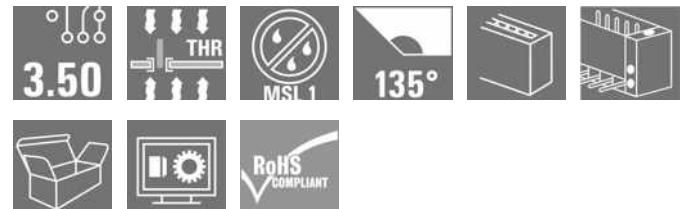

**High-temperature-resistant male header, 3.50 mm pitch.**

- **Plugging direction parallel (90°), straight 180° or angled (135°) to PCB**
- **Housing variants: closed side (G), screw flange (F), solder flange (LF) or snap-on solder flange (RF)**
- **Optimised for the SMT process**
- **Pin length 3.2 mm universal for all soldering methods**
- **Pin length 1.5 mm optimised for reflow soldering methods**
- **Packed either in a box (BX) or tape-on-reel (RL)**
- **Male header can be coded**

### General ordering data

Version	PCB plug-in connector, male header, Flange, THT/THR solder connection, 3.50 mm, Number of poles: 18, 135°, Solder pin length (l): 3.2 mm, tinned, black, Box
Order No.	<a href="#">1003680000</a>
Type	SL-SMT 3.50/18/135F 3.2SN BK BX
GTIN (EAN)	4032248700301
Qty.	24 pc(s).
Product data	IEC: 320 V / 15 A UL: 300 V / 10 A
Packaging	Box

## SL-SMT 3.50/18/135F 3.2SN BK BX

**Weidmüller Interface GmbH & Co. KG**  
 Klingenbergstraße 26  
 D-32758 Detmold  
 Germany

www.weidmueller.com

## Technical data

### Dimensions and weights

Depth	13.2 mm	Depth (inches)	0.52 inch
Height	16.2 mm	Height (inches)	0.638 inch
Height of lowest version	13 mm	Width	70 mm
Width (inches)	2.756 inch	Net weight	5.86 g

### Temperatures

Operating temperature, min.	-50 °C	Operating temperature, max.	100 °C
-----------------------------	--------	-----------------------------	--------

### System specifications

Product family	OMNIMATE Signal - series BL/SL 3.50		
Type of connection	Board connection		
Mounting onto the PCB	THT/THR solder connection		
Pitch in mm (P)	3.5 mm		
Pitch in inches (P)	0.138 inch		
Outgoing elbow	135°		
Number of poles	18		
Number of solder pins per pole	1		
Solder pin length (l)	3.2 mm		
Solder pin dimensions	d = 1.2 mm, Octagonal		
Solder eyelet hole diameter (D)	1.3 mm		
Solder eyelet hole diameter tolerance (D)	+ 0,1 mm		
Outside diameter of solder pad	2.3 mm		
Template aperture diameter	2.1 mm		
L1 in mm	59.5 mm		
L1 in inches	2.343 inch		
Number of rows	1		
Pin series quantity	1		
Touch-safe protection acc. to DIN VDE 57 106	finger-safe plugged/ back-of-hand-safe unplugged		
Touch-safe protection acc. to DIN VDE 0470	IP20 plugged/ IP10 unplugged		
Protection degree	IP10		
Volume resistance	≤5 mΩ		
Plugging cycles	25		
Plugging force/pole, max.	10 N		
Pulling force/pole, max.	8 N		
Tightening torque	Torque type	Mounting screw, PCB	
	Usage information	Tightening torque	min. 0.1 Nm max. 0.15 Nm
		Recommended screw	Part number <a href="#">PTSC KA 2.2X4.5 WN1412</a>

## SL-SMT 3.50/18/135F 3.2SN BK BX

Weidmüller Interface GmbH &amp; Co. KG

Klingenbergstraße 26

D-32758 Detmold

Germany

www.weidmueller.com

## Technical data

## Material data

Insulating material	LCP GF	Colour	black
Colour chart (similar)	RAL 9011	Insulating material group	IIIa
Comparative Tracking Index (CTI)	≥ 175	Moisture Level (MSL)	1
UL 94 flammability rating	V-0	Contact material	CuSn
Contact surface	tinned	Layer structure of solder connection	2...4 µm Ni / 5...8 µm Sn glossy
Layer structure of plug contact	2...4 µm Ni / 5...8 µm Sn glossy	Storage temperature, min.	-40 °C
Storage temperature, max.	70 °C	Operating temperature, min.	-50 °C
Operating temperature, max.	100 °C	Temperature range, installation, min.	-30 °C
Temperature range, installation, max.	100 °C		

## Rated data acc. to IEC

tested acc. to standard	IEC 60664-1, IEC 61984	Rated current, min. number of poles (Tu=20°C)	15 A
Rated current, max. number of poles (Tu=20°C)	12 A	Rated current, min. number of poles (Tu=40°C)	13 A
Rated current, max. number of poles (Tu=40°C)	10 A	Rated voltage for surge voltage class / pollution degree II/2	320 V
Rated voltage for surge voltage class / pollution degree III/2	160 V	Rated voltage for surge voltage class / pollution degree III/3	160 V
Rated impulse voltage for surge voltage class/ pollution degree II/2	2.5 kV	Rated impulse voltage for surge voltage class/ pollution degree III/2	2.5 kV
Rated impulse voltage for surge voltage class/ contamination degree III/3	2.5 kV		

## Rated data acc. to CSA

Rated voltage (Use group B / CSA)	300 V	Rated voltage (Use group D / CSA)	300 V
Rated current (Use group B / CSA)	10 A	Rated current (Use group D / CSA)	10 A

## Rated data acc. to UL 1059

Institute (UR)		Certificate No. (UR)	E60693
Rated voltage (Use group B / UL 1059)	300 V	Rated voltage (Use group D / UL 1059)	300 V
Rated current (Use group B / UL 1059)	10 A	Rated current (Use group D / UL 1059)	10 A
Reference to approval values	Specifications are maximum values, details - see approval certificate.		

## Packing

Packaging	Box	VPE length	350 mm
VPE width	138 mm	VPE height	27 mm

## Classifications

ETIM 6.0	EC002637	ETIM 7.0	EC002637
ETIM 8.0	EC002637	ETIM 9.0	EC002637
ECLASS 9.0	27-44-04-02	ECLASS 9.1	27-44-04-02
ECLASS 10.0	27-44-04-02	ECLASS 11.0	27-46-02-01
ECLASS 12.0	27-46-02-01	ECLASS 13.0	27460201

Creation date October 11, 2023 10:57:37 AM CEST

Catalogue status 30.09.2023 / We reserve the right to make technical changes.

## SL-SMT 3.50/18/135F 3.2SN BK BX

**Weidmüller Interface GmbH & Co. KG**  
Klingenbergstraße 26  
D-32758 Detmold  
Germany

www.weidmueller.com

## Technical data

### Important note

IPC conformity	Conformity: The products are developed, manufactured and delivered according international recognized standards and norms and comply with the assured properties in the data sheet resp. fulfill decorative properties in accordance with IPC-A-610 "Class 2". Further claims on the products can be evaluated on request.
Notes	<ul style="list-style-type: none"> <li>• Gold-plated contact surfaces on request</li> <li>• Rated current related to rated cross-section &amp; min. No. of poles.</li> <li>• Diameter of solder eyelet D = 1.4+0.1mm</li> <li>• Solder eyelet diameter D = 1.5 + 0.1 mm, from 9 poles</li> <li>• P on drawing = pitch</li> <li>• Rated data refer only to the component itself. Clearance and creepage distances to other components are to be designed in accordance with the relevant application standards.</li> <li>• Long term storage of the product with average temperature of 50 °C and maximum humidity 70%, 36 months</li> </ul>

### Approvals

Approvals



ROHS	Conform
UL File Number Search	UL Website
Certificate No. (UR)	E60693

### Downloads

Approval/Certificate/Document of Conformity	<a href="#">Declaration of the Manufacturer</a>
Engineering Data	<a href="#">CAD data – STEP</a>
Catalogues	<a href="#">Catalogues in PDF-format</a>
Brochures	<a href="#">FL DRIVES EN</a> <a href="#">MB SMT EN</a> <a href="#">FL DRIVES DE</a> <a href="#">MB DEVICE MANUF. EN</a> <a href="#">FL BUILDING SAFETY EN</a> <a href="#">FL APPL LED LIGHTING EN</a> <a href="#">FL INDUSTR.CONTROLS EN</a> <a href="#">FL MACHINE SAFETY EN</a> <a href="#">FL HEATING ELECTR EN</a> <a href="#">FL APPL INVERTER EN</a> <a href="#">FL_BASE_STATION_EN</a> <a href="#">FL ELEVATOR EN</a> <a href="#">FL POWER SUPPLY EN</a> <a href="#">FL 72H SAMPLE SER EN</a> <a href="#">PO OMNIMATE EN</a> <a href="#">PO OMNIMATE EN</a>
White paper surface mount technology	<a href="#">Download Whitepaper</a>

**Data sheet**

**SL-SMT 3.50/18/135F 3.2SN BK BX**

**Weidmüller Interface GmbH & Co. KG**  
 Klingenbergstraße 26  
 D-32758 Detmold  
 Germany

www.weidmueller.com

**Drawings**

**Product image**



**Dimensional drawing**

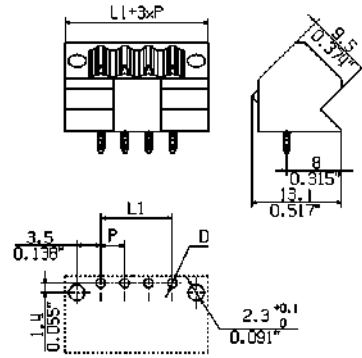

LAYOUT FINISHED HOLES

Similar to illustration

**Example of use**

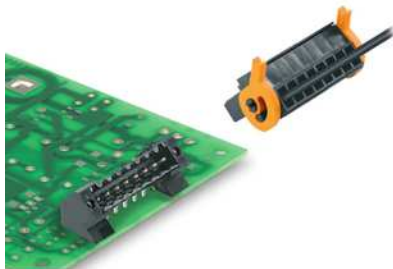

## SL-SMT 3.50/18/135F 3.2SN BK BX

**Weidmüller Interface GmbH & Co. KG**  
 Klingenbergstraße 26  
 D-32758 Detmold  
 Germany

www.weidmueller.com

# Accessories

## Coding elements



**Only connects what is supposed to be connected: the right connection at the right place.**

Coding elements and locking devices clearly assign connecting elements during the manufacturing process and operation

The coding elements and locking devices are inserted prior to assembly or during the cable assembly phase. The Weidmüller alternative: configure online using the variant configurator to precode prior to delivery.

Incorrect assembly on the circuit board and incorrect plugging of connecting elements is no longer possible. The advantage: no troubleshooting during manufacture and no operational errors by the user.

## General ordering data

Type	BL SL 3.5 KO OR	Version	Product data	Packaging
Order No.	<a href="#">1693430000</a>	PCB plug-in connector, Accessories, Coding element, orange, Number		Box
GTIN (EAN)	4008190867447	of poles: 1		
Qty.	100 pc(s).			
Type	BL SL 3.5 KO SW	Version	Product data	Packaging
Order No.	<a href="#">1610100000</a>	PCB plug-in connector, Accessories, Coding element, black, Number		Box
GTIN (EAN)	4008190187637	of poles: 1		
Qty.	100 pc(s).			

MASSE OHNE TOLERANZ SIND KEINE PRUEFMASSE  
 DIMS. WITHOUT TOLERANCE ARE NOT CONTROL DIMS.

DIE DEUTSCHE VERSION IST VERBINDLICH  
 THE GERMAN VERSION IS BINDING

**Technical Data**

Rev.	Material data	
	Insulation material type	LCP
	Insulation material colors	black
	Insulation material flammability class	UL94
	Insulation resistance	MOhm
	Contact base material	CuSn
	Contact plating (mating end)	see order sheet
	Contact plating (solder end)	see order sheet
	<b>System characteristic values</b> together with counterpart	BL 3.5
	Pitch P	mm/inch 3.5/0.138
	Number of rows	1
	Dielectric strength (r.m.s withstand voltage)	kV >2.2
	Mechanical operating cycles	acc.to IEC512 25
	Plug in force (max.)	N/Pole 10 1)
	Pull out force (max.)	N/Pole 10 1)
	Through resistance (typical)	m Ohm 4.5
	Operating temperature range	°C -20..100 2)
	Degree of protection acc. to VDE 0106 (plugged/unplugged)	finger safe/back of hands
	Degree of protection acc. to DIN EN 60529(plugged/unplugged)	IP20/IP10
	Solder pin length L	mm/inch 3.2/0.126
	PCB hole diameter D (wave soldering)	mm/inch 1.3+0.1/0.51+0.004 3)
	PCB hole diameter D (reflow soldering)	mm/inch n.a. 4)
	Resistance to soldering heat acc. to DIN IEC 60512-6	°C/sec - 5)
	Resistance to soldering heat acc. to EN 61760-1	°C/sec 290/30 6)
	Solderability classification acc. to EN 61760-1	class A
	Solder connection type	Reflow
	Solder pin diameter d (max.)	mm/inch 1.2/0.047

Application notes		
Coding possibility	yes/no	yes (accessory)
Joinable without loss of pitch	yes/no	no
Manual assembly of modules	yes/no	no
Max. number of poles	n	24

IEC 664-1 / VDE0110 (4.97) rated data		
Rated cross section acc. to EN 60999	mm <sup>2</sup>	n.a.
Rated current @ 20°C ambient (together with)	A	16.8 (BL3.5) 7)
Rated current @ 40°C ambient (together with)	A	14.4 (BL3.5) 7)
<b>Overvoltage category / Pollution degree</b>		III/3 III/2 II/2
Rated voltage	V	160 160 250
Rated impulse voltage	kV	2.5 2.5 2.5

UL 1059 rated data		
Rated voltage	V	300 - 300
Rated current	A	10 - 10
AWG wire range (field wiring / factory wiring)		n.a.

CSA C22.2 rated data		
Rated voltage	V	300 - 300
Rated current	A	10 - 10
AWG wire range (field wiring / factory wiring)		n.a.

**Packaging** cardboard

**Downloads** www.weidmueller.de..

- 1) Without locking latches
- 2) Sum of ambient temperature and temperature rise
- 3) Recommendation for manual assembly
- 4) Recommendation for automatic assembly
- 5) Recommendation for wave soldering
- 6) Recommendation for reflow soldering
- 7) Referred to rated cross section and minimum pole number

n.a. = not applicable

Subject to technical changes

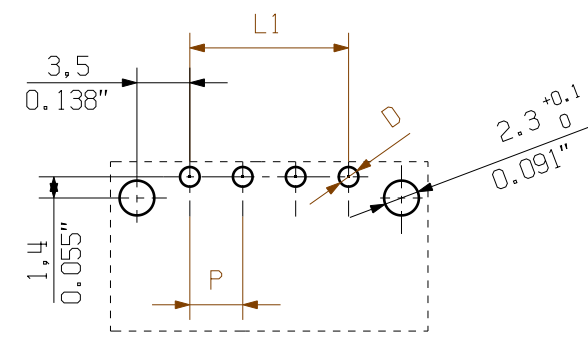
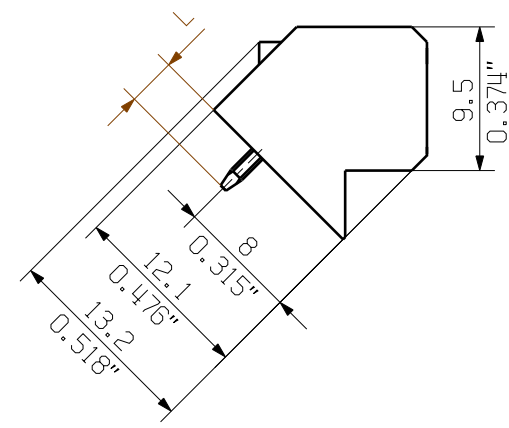
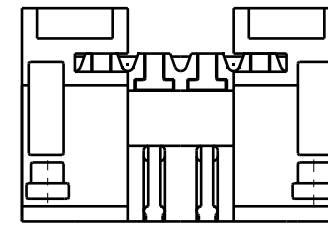
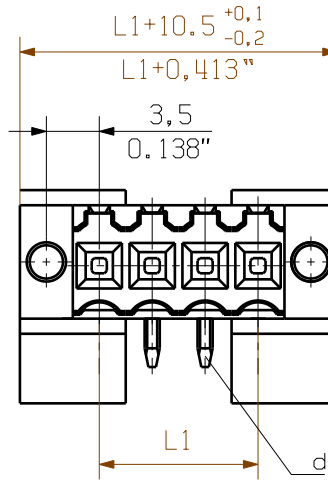

LAYOUT FINISHED HOLES

24	80,50	3,169
23	77,00	3,031
22	73,50	2,894
21	70,00	2,756
20	66,50	2,618
19	63,00	2,480
18	59,50	2,343
17	56,00	2,205
16	52,50	2,067
15	49,00	1,929
14	45,50	1,791
13	42,00	1,654
12	38,50	1,516
11	35,00	1,378
10	31,50	1,240
9	28,00	1,102
8	24,50	0,965
7	21,00	0,827
6	17,50	0,689
5	14,00	0,551
4	10,50	0,413
3	7,00	0,276
2	3,50	0,138
n	L1 [mm]	L1 [inch]

STIFTLAENGE L	TOLERANZ
3,2	0,1
	-0,3

SHOWN: SL3.5/4/135F

For the mounting of PCBs, it should be noted that the rated data given in the catalogue relates only to the connection elements. The necessary creepage and clearance paths must be observed in connection with the respective applicant in accordance to VDE 0110. The current-carrying capacity and pitch tolerance is to be determined according to DIN IEC 326 part 3 very fine.

Weidmüller connectors are tested to the DIN VDE 0627 standard, and are valid for its field of application. Provided that the connectors are used to the intended purpose, all requirements with respect to the occurring of electrical, mechanical, thermic and corrosive stress will be satisfied.

	METRIC TOLERANCES: X. = ±0.3 X.X = ±0.1 X.XX = ±0.05	39056/5 07.07.08 HELIS_MA 01	CAT.NO.: <b>C 42538 01</b>
		MODIFICATION	DRAWING NO. SHEET 02 OF 03 SHEETS ISSUE NO.
	DRAWN 04.07.2008 HELIS_MA RESPONSIBLE HERTEL_S CHECKED 07.07.2008 HECKERT_M APPROVED HECKERT_M	DATE NAME	<b>SL SMT 3.5/././135F</b> STIFTLAENGE PIN HEADER
SCALE: 2/1 SUPERSEDES:	PRODUCT FILE: SL-SMT 3.5	7312	

WEIDMUELLER INTERFACE GmbH & Co.KG  
 WEITERGABE SOWIE Vervielfaeltigung dieses Dokuments, Verwertung und Mitteilung seines Inhalts sind verboten, soweit nicht ausdruecklich gestattet.  
 ZUWIDERHANDLUNGEN VERPFLICHTEN ZU SCHADENERSATZ. ALLE RECHTE FUER DEN FALL DER PATENT-, GEBRAUCHSMUSTER-, ODER GESCHMACKSMUSTEREINTRAGUNG VORBEHALTEN.  
 THE REPRODUCTION, DISTRIBUTION AND UTILIZATION OF THIS DOCUMENT AS WELL AS THE COMMUNICATION OF ITS CONTENTS TO OTHERS WITHOUT EXPLICIT AUTHORIZATION IS PROHIBITED.  
 OFFENDERS WILL BE HELD LIABLE FOR THE PAYMENT OF DAMAGES. WEIDMUELLER EXCLUSIVELY RESERVES THE RIGHT TO FILE FOR PATENTS, UTILITY MODELS OR DESIGNS.

## Recommended wave soldering profiles

**Weidmüller Interface GmbH & Co. KG**  
 Klängenbergstraße 16  
 D-32758 Detmold  
 Germany  
 Fon: +49 5231 14-0  
 Fax: +49 5231 14-292083  
 www.weidmueller.com

### Single Wave:



### Double Wave:



### Wave soldering profiles

Wired connection elements should be processed in accordance with the DIN EN 61760-1 standard. We have included two recommendations for practical wave soldering profiles, with which Weidmüller PCB terminals and connectors are qualified.

When choosing a suitable profile for your application, the following factors also need to be considered:

- PCB thickness
- Proportion of Cu in the layers
- Single/double-sided assembly
- Product range
- Heating and cooling rates

The single and double wave profiles each indicate the recommended operating range, including the maximum soldering temperature of 260°C. In practice, the maximum soldering temperature is quite often well below the above maximum profile.

## Recommended reflow soldering profile

**Weidmüller Interface GmbH & Co. KG**  
 Klingenbergstraße 16  
 D-32758 Detmold  
 Germany  
 Fon: +49 5231 14-0  
 Fax: +49 5231 14-292083  
 www.weidmueller.com



### Reflow soldering profile

The perfect soldering profile for SMT Surface Mount Technology is one the most exiting question in SMT production. But there are more than one correct answer: The diagram of temperature-on-time is related to processing features of solder paste and to maximum load of components.

We have to consider the following parameters:

- Time for pre heating
- Maximum temperature
- Time above melting point
- Time for cooling
- Maximum heating rate
- Maximum cooling rate

We recommend a typical solder profile with associated process limits. With preheating components and board are prepared smoothly for the solder phase. Heating rate is typically  $\leq +3\text{K/s}$ . In parallel the solder paste is ,activated'. The time above melting point of  $217^\circ\text{C}$  the paste gets liquid and components and boards begin to connect. The maximum temperature of  $245^\circ\text{C}$  to  $254^\circ\text{C}$  should stay between 10 and 40 seconds. In the cooling phase at  $\geq -6\text{K/s}$  solder is cured. Board and components cool down while avoiding cold cracks.