

# TERMINALS

## 10-502-X-XX

MATERIAL: BRASS  
FINISH: SILVER (01)  
GOLD (03)  
ELECTRO-SOLDER (05)

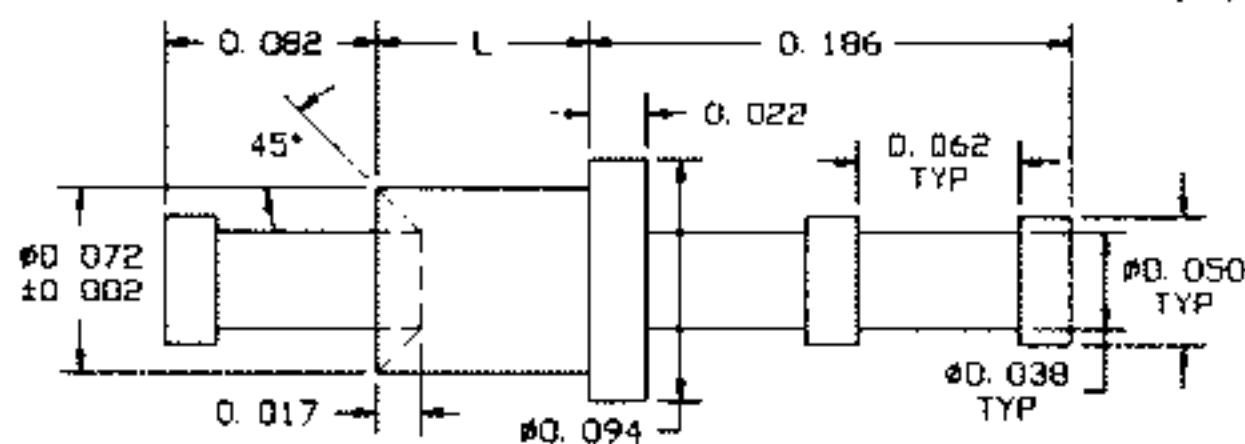

PART NO.	L	T	RECOMMENDED MOUNTING HOLE .076 DIA. (#48 DRILL)
10-502-1	.051	1/32	
10-502-2	.082	1/16	
10-502-3	.113	3/32	
10-502-4	.145	1/8	
10-502-6	.207	3/16	
10-502-8	.270	1/4	

TOOLS	
ANVIL	PUNCH
TA94-50-20	TP72-T50

## 10-505-X-01

MATERIAL: BRASS  
FINISH: SILVER (01)

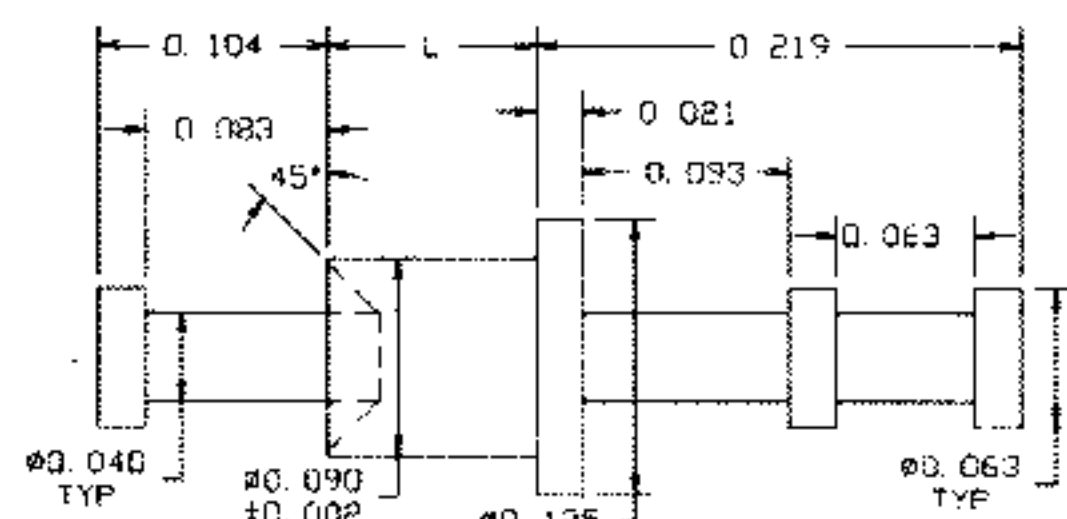

RECOMMENDED MOUNTING HOLE .094 DIA. (#42 DRILL)

PART NO.	L	T	RECOMMENDED MOUNTING HOLE .094 DIA. (#42 DRILL)
10-505-1	.062	1/32	
10-505-2	.094	1/16	
10-505-3	.125	3/32	
10-505-4	.156	1/8	

TOOLS	
ANVIL	PUNCH
TA125-63-20	TP92-T62

## 10-543-X-01

MATERIAL: BRASS  
FINISH: SILVER

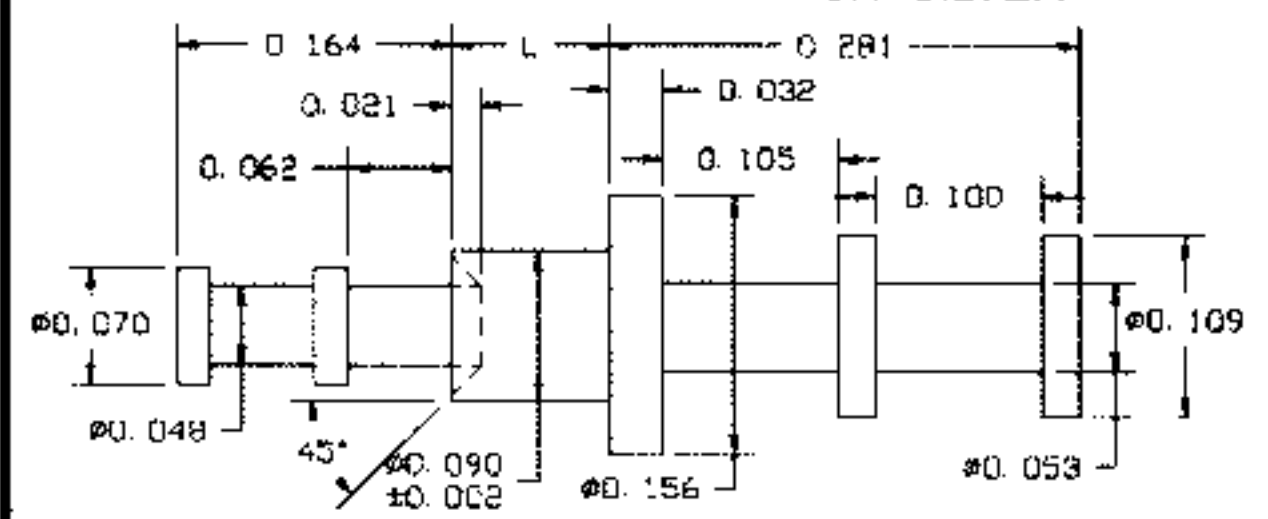

PART NO.	L	T	RECOMMENDED MOUNTING HOLE .094 DIA. (#42 DRILL)
10-543-1	.062	1/32	
10-543-2	.094	1/16	
10-543-3	.125	3/32	
10-543-4	.156	1/8	
10-543-6	.219	3/16	

TOOLS	
ANVIL	PUNCH
TA156-109-32	TP90-T70

## 10-503-X-XX

MATERIAL: BRASS  
FINISH: SILVER (01)  
ELECTRO-SOLDER (05)

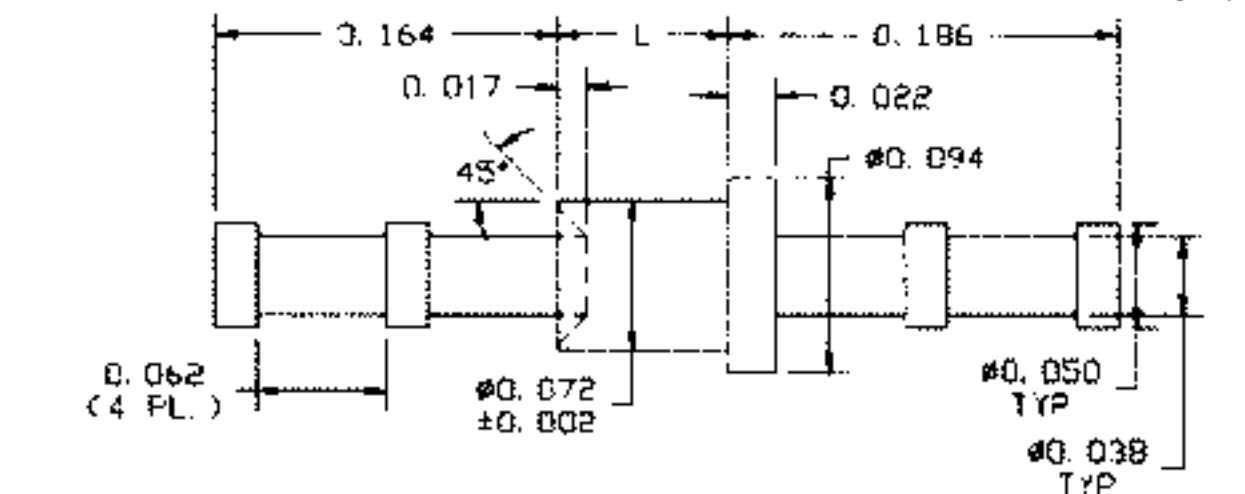

PART NO.	L	T	RECOMMENDED MOUNTING HOLE .076 DIA. (#48 DRILL)
10-503-1	.051	1/32	
10-503-2	.082	1/16	
10-503-3	.113	3/32	
10-503-4	.145	1/8	
10-503-6	.207	3/16	
10-503-8	.270	1/4	

TOOLS	
ANVIL	PUNCH
TA94-50-20	TP72-T50

## 13-554-X-01

MATERIAL: BRASS  
FINISH: SILVER

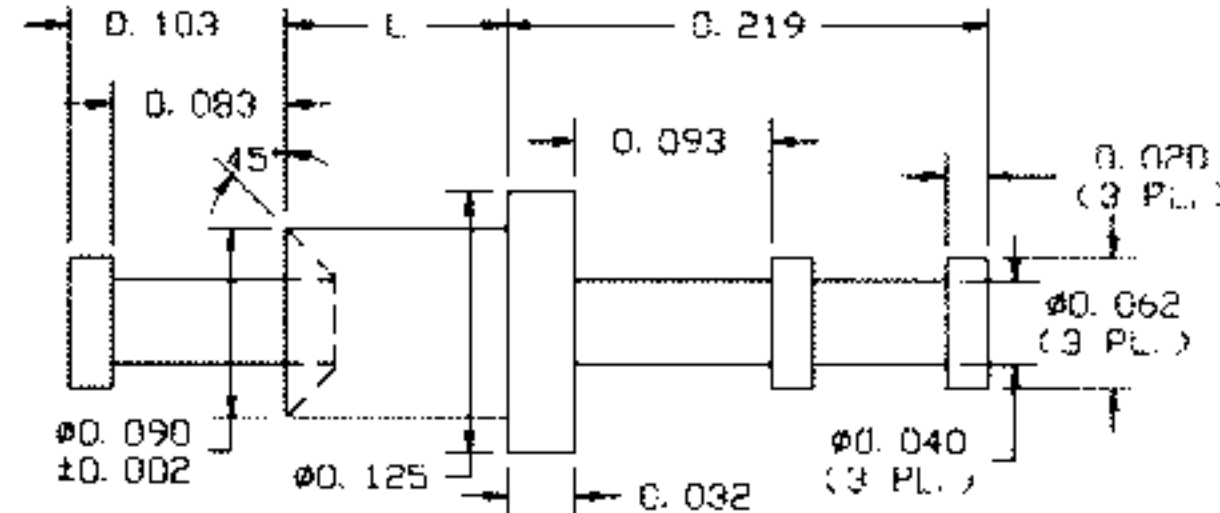

RECOMMENDED MOUNTING HOLE .094 DIA. (#42 DRILL)

PART NO.	L	T	RECOMMENDED MOUNTING HOLE .094 DIA. (#42 DRILL)
13-554-1	.075	1/32	
13-554-2	.105	1/16	
13-554-3	.135	3/32	
13-554-4	.165	1/8	

TOOLS	
ANVIL	PUNCH
TA125-63-30	TP92-T62

## 12-556-X-01

MATERIAL: BRASS  
FINISH: SILVER

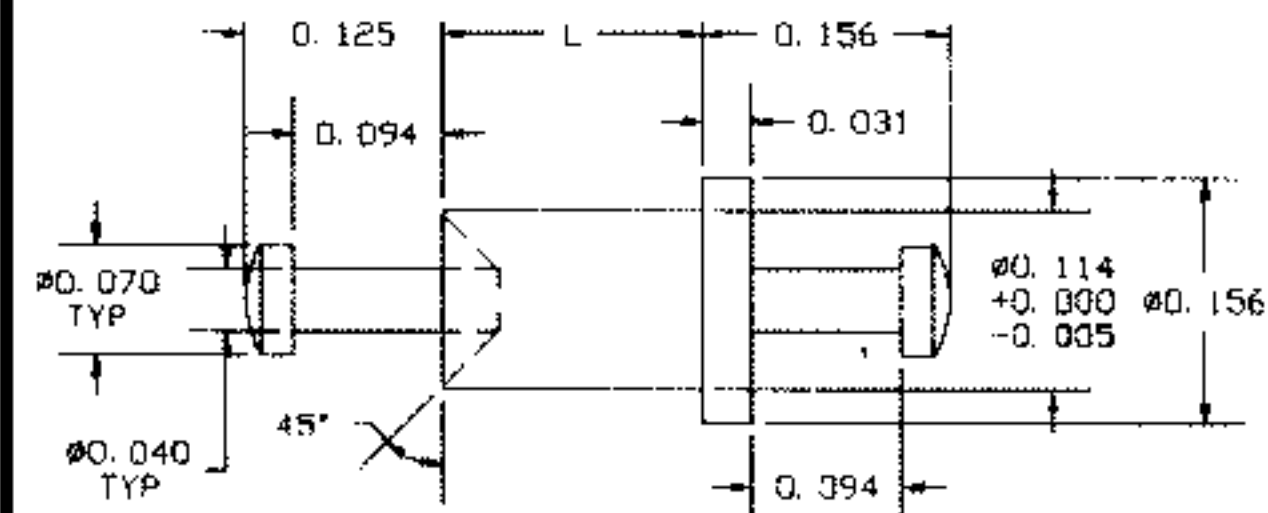

RECOMMENDED MOUNTING HOLE .116 DIA. (#32 DRILL)

PART NO.	L	T	RECOMMENDED MOUNTING HOLE .116 DIA. (#32 DRILL)
12-556-1	.075	1/32	
12-556-2	.105	1/16	
12-556-3	.135	3/32	
12-556-4	.165	1/8	

TOOLS	
ANVIL	PUNCH
TA156-70-32	TP116-T70

## 11-559-X-01

MATERIAL: BRASS  
FINISH: SILVER

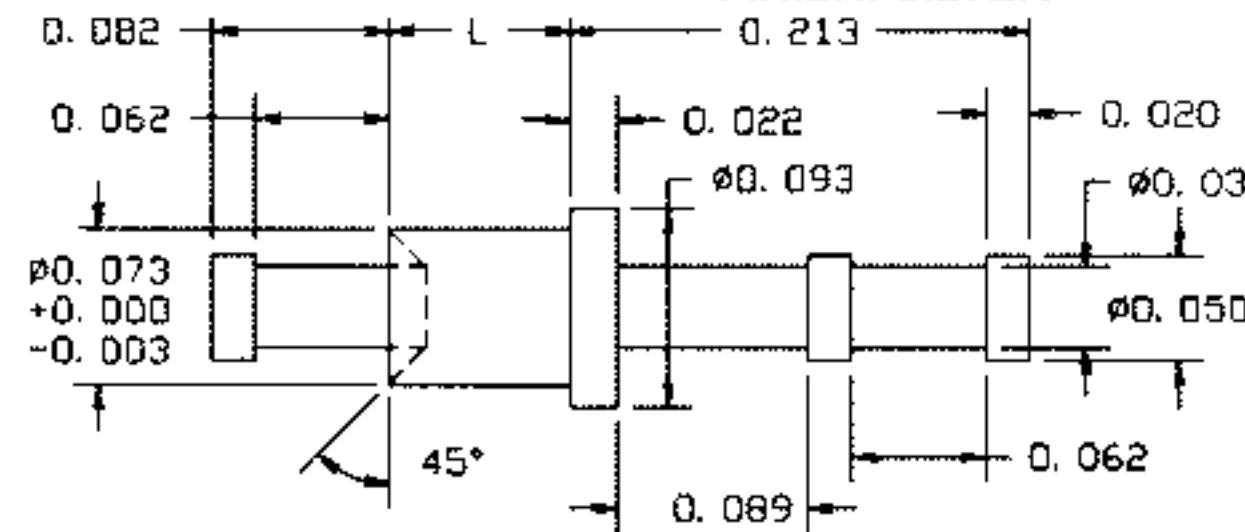

RECOMMENDED MOUNTING HOLE .076 DIA. (#48 DRILL)

PART NO.	L	T	RECOMMENDED MOUNTING HOLE .076 DIA. (#48 DRILL)
11-559-1	.053	1/32	
11-559-2	.084	1/16	
11-559-3	.115	3/32	
11-559-4	.147	1/8	

TOOLS	
ANVIL	PUNCH
TA94-50-20	TP72-T50

## 10-504-X-01

MATERIAL: BRASS  
FINISH: SILVER (01)

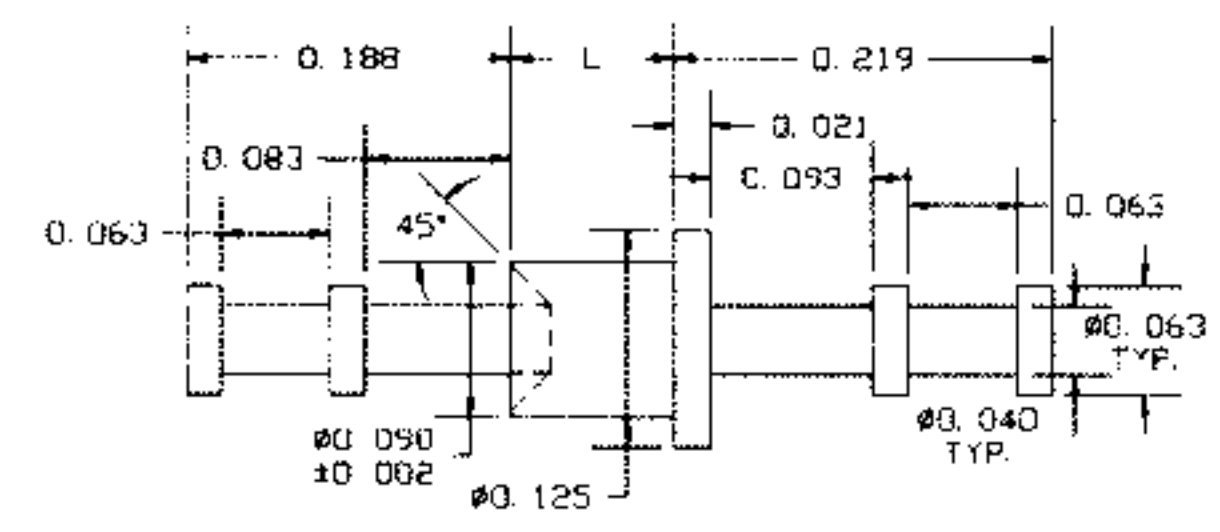

RECOMMENDED MOUNTING HOLE .094 DIA. (#42 DRILL)

PART NO.	L	T	RECOMMENDED MOUNTING HOLE .094 DIA. (#42 DRILL)
10-504-1	.062	1/32	
10-504-2	.094	1/16	
10-504-3	.125	3/32	
10-504-4	.156	1/8	

TOOLS	
ANVIL	PUNCH
TA125-63-20	TP92-T62

## 11-510-X-01

MATERIAL: BRASS  
FINISH: SILVER

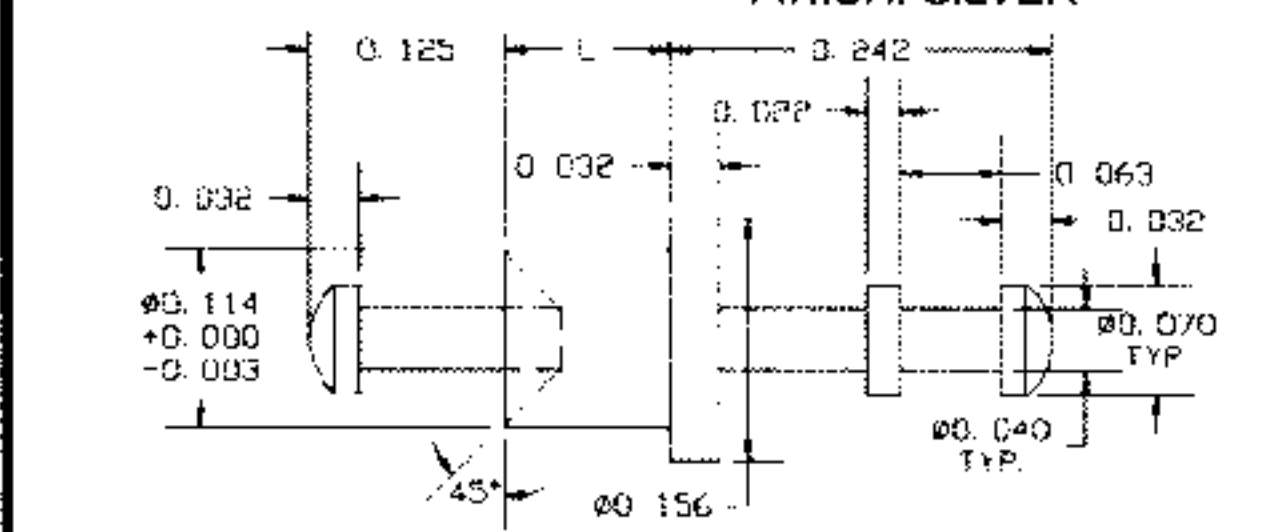

RECOMMENDED MOUNTING HOLE .116 DIA. (#32 DRILL)

PART NO.	L	T	RECOMMENDED MOUNTING HOLE .116 DIA. (#32 DRILL)
11-510-1	.075	1/32	
11-510-2	.105	1/16	
11-510-3	.135	3/32	
11-510-4	.165	1/8	

TOOLS	
ANVIL	PUNCH
TA156-70-32	TP116-T70

## 13-533-X-01

MATERIAL: BRASS  
FINISH: SILVER

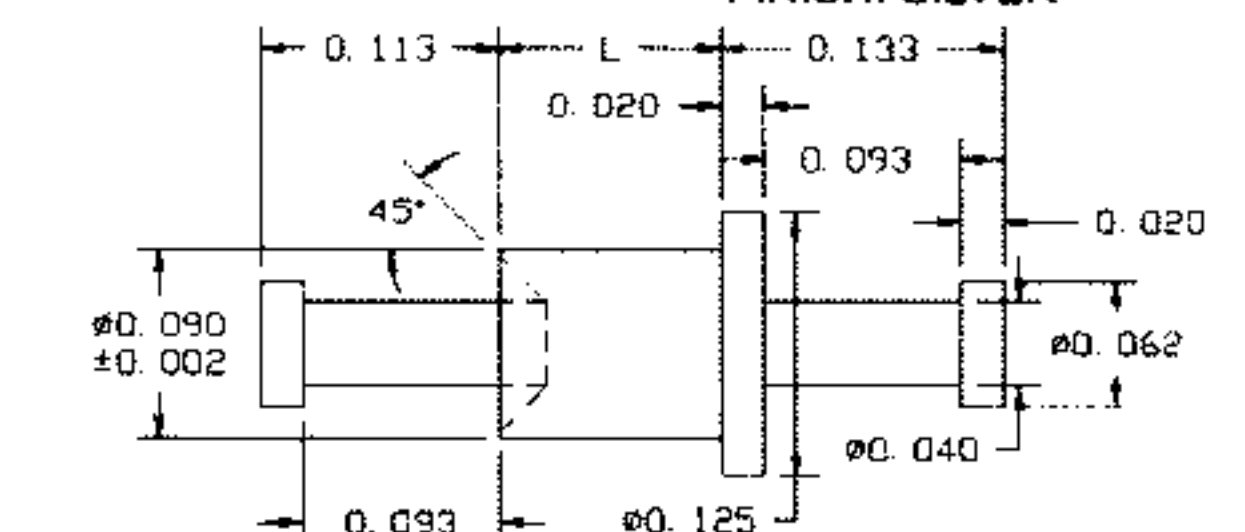

RECOMMENDED MOUNTING HOLE .094 DIA. (#42 DRILL)

PART NO.	L	T	RECOMMENDED MOUNTING HOLE .094 DIA. (#42 DRILL)
13-533-1	.075	1/32	
13-533-2	.105	1/16	
13-533-3	.135	3/32	
13-533-4	.165	1/8	

TOOLS	
ANVIL	PUNCH
TA125-63-20	TP92-T62

## 12-525-X-01

MATERIAL: BRASS  
FINISH: SILVER

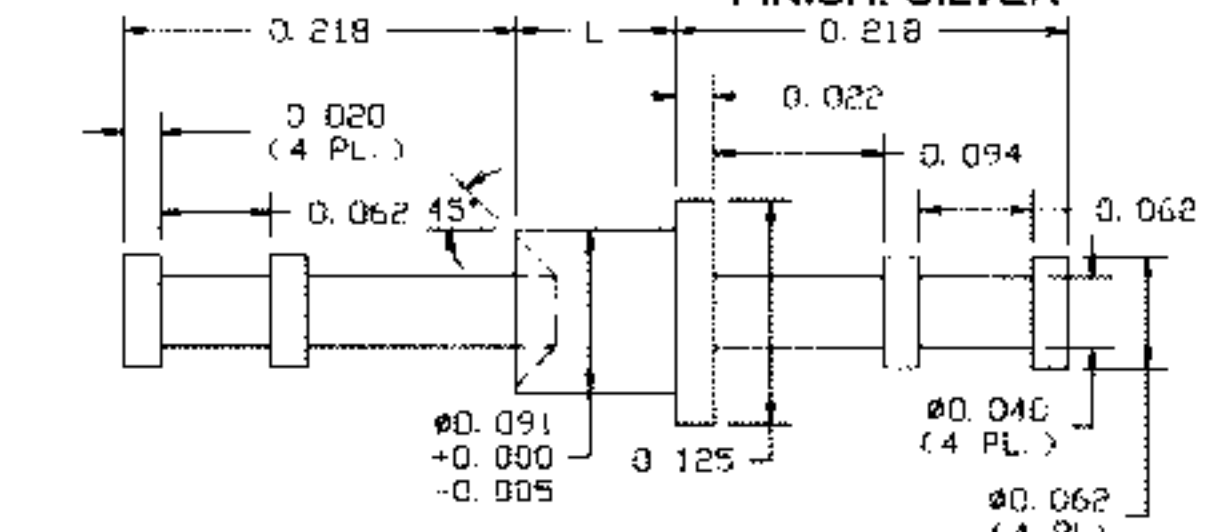

RECOMMENDED MOUNTING HOLE .094 DIA. (#42 DRILL)

PART NO.	L	T	RECOMMENDED MOUNTING HOLE .094 DIA. (#42 DRILL)
12-525-1	.053	1/32	
12-525-2	.084	1/16	
12-525-3	.115	3/32	
12-525-4	.147	1/8	

TOOLS	
ANVIL	PUNCH
TA125-63-20	TP92-T62

## 10-541-X-05

MATERIAL: BRASS  
FINISH: ELECTRO-SOLDER

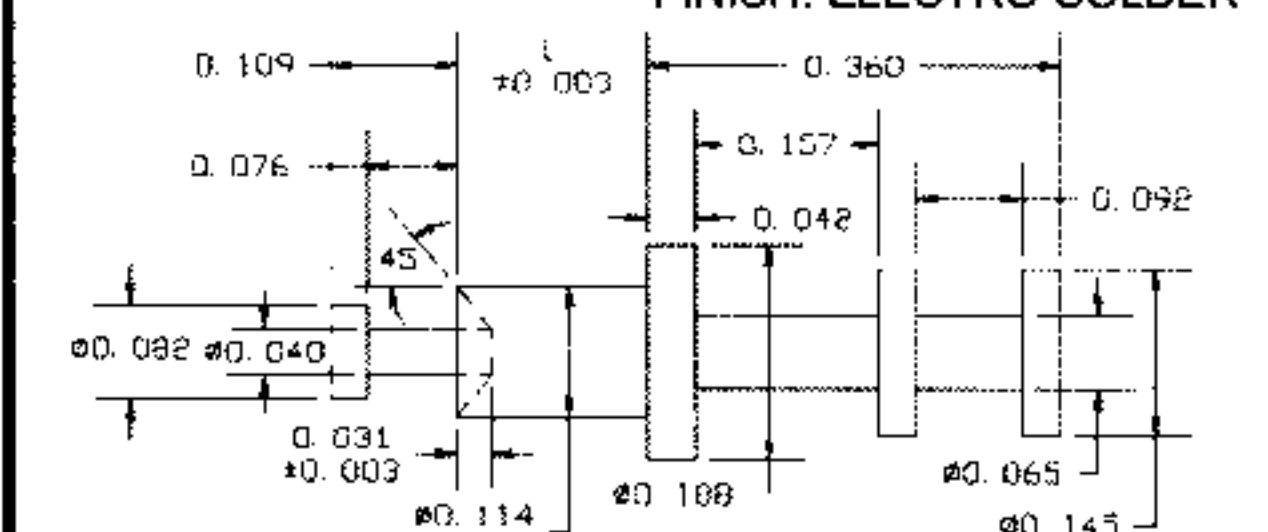

RECOMMENDED MOUNTING HOLE .116 DIA. (#32 DRILL)

PART NO.	L	T	RECOMMENDED MOUNTING HOLE .116 DIA. (#32 DRILL)
10-541-2	.105	1/16	
10-541-3	.135	3/32	
10-541-4	.165	1/8	

TOOLS	
ANVIL	PUNCH
TA188-146-31	TP114-T82

## 10-544-X-01

MATERIAL: BRASS  
FINISH: SILVER

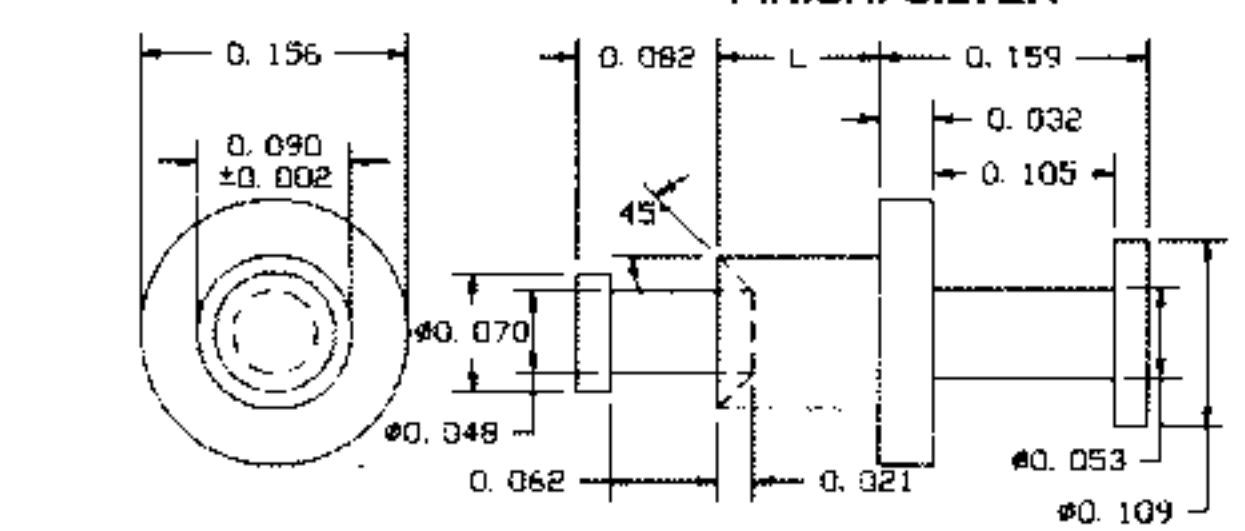

PART NO.	L	T	RECOMMENDED MOUNTING HOLE .094 DIA. (#42 DRILL)
10-544-1	.062	1/32	
10-544-2	.094	1/16	
10-544-3	.125	3/32	
10-544-4	.156	1/8	
10-544-6	.219	3/16	

TOOLS	
ANVIL	PUNCH
TA156-109-32	TP90-T70

## 10-542-X-01

MATERIAL: BRASS  
FINISH: SILVER

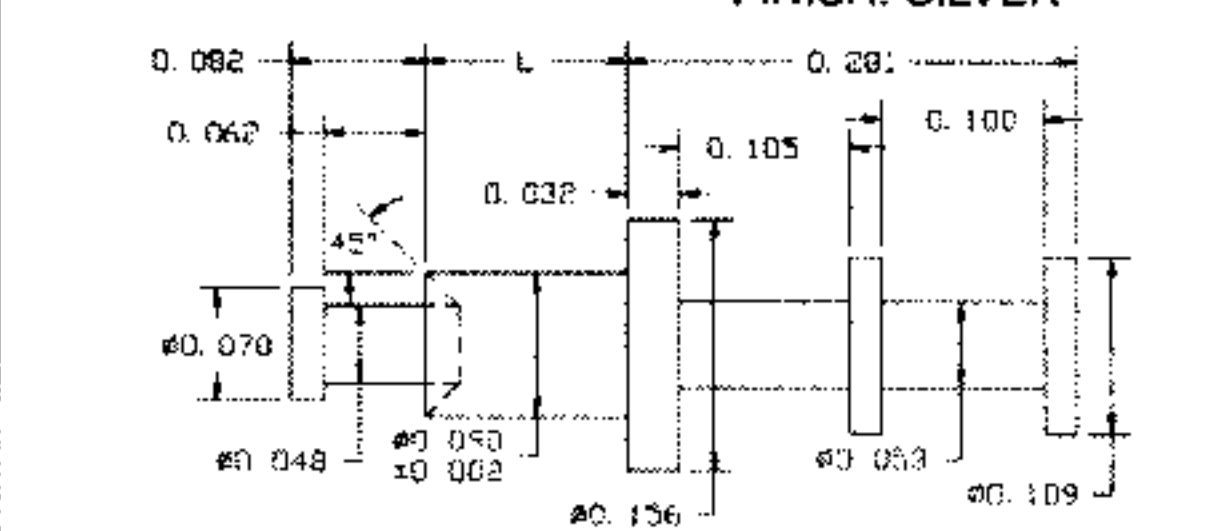

PART NO.	L	T	RECOMMENDED MOUNTING HOLE .094 DIA. (#42 DRILL)
10-542-1	.062	1/32	
10-542-2	.094	1/16	
10-542-3	.125	3/32	
10-542-4	.156	1/8	
10-542-6	.219	3/16	

TOOLS	
ANVIL	PUNCH
TA156-109-32	TP90-T70

## 10-560-X-05

MATERIAL: BRASS  
FINISH: ELECTRO-SOLDER

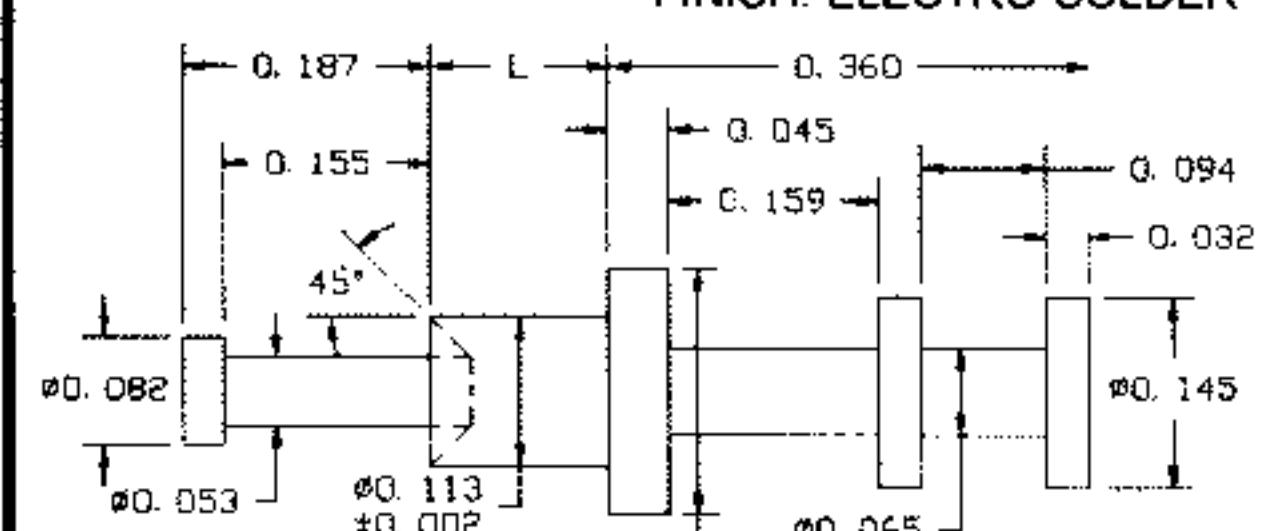

RECOMMENDED MOUNTING HOLE .116 DIA. (#32 DRILL)

PART NO.	L	T	RECOMMENDED MOUNTING HOLE .116 DIA. (#32 DRILL)
10-560-2	.105	1/16	
10-560-3	.135	3/32	
10-560-4	.165	1/8	

TOOLS	
ANVIL	PUNCH
TA188-146-31	TP114-T82

FOR ADDITIONAL SIZES AND MATERIALS, CONTACT FACTORY

