

## Transient Voltage Suppressors (TVS) Data Sheet

### Features

- For surface mounted applications in order to optimize board space
- Low profile package
- Built-in strain relief
- Glass passivated junction
- Low inductance
- Excellent clamping capability
- 1500W peak pulse power capability at 10/1000µs waveform, repetition rate (duty cycle): 0.01%
- Fast response time
- Typical  $I_R$  less than 1µA above 12V
- High Temperature soldering: 260°C/10 seconds at terminals
- Plastic package has underwriters laboratory flammability 94V-0
- Meets MSL level 1, per J-STD-020
- Safety certification: UL: E244458
- AEC-Q101 qualified



### Mechanical Data

- Case: JEDEC DO-214AB. Molded plastic over glass passivated junction
- Terminal: Solder plated, solderable per MIL-STD-750, Method 2026
- Polarity: Color band denotes cathode except bi-directional models
- Standard Packaging: 16mm tape (EIA STD RS-481)
- Weight: 0.26g

### Applications

- I/O interface
- AC/DC power supply
- Low frequency signal transmission line (RS232, RS485, etc.)

### Maximum Ratings and Characteristics

Ratings at 25°C ambient temperature unless otherwise specified.

Rating	Symbol	Value	Units
Peak pulse power dissipation at 10/1000µs waveform (Note1, Note2, Fig.1)	$P_{PPM}$	Minimum 1500	Watts
Peak pulse current of at 10/1000µs waveform (Note 1, Fig.3)	$I_{PPM}$	See Table	Amps
Steady state power dissipation at $T_A=50^\circ\text{C}$ (Fig.5)	$P_{M(AV)}$	6.5	Watts
Peak forward surge current, 8.3ms single half sine-wave superimposed on rated load, (JEDEC Method) (Note3, Fig.6)	$I_{FSM}$	200	Amps
Operating junction and Storage Temperature Range.	$T_J, T_{STG}$	-55 to +150	°C
Typical thermal resistance junction to lead	$R_{\theta JL}$	15	°C/W
Typical thermal resistance junction to ambient	$R_{\theta JA}$	75	°C/W

Notes: 1. Non-repetitive current pulse, per Fig.3 and derated above  $T_A=25^\circ\text{C}$  per Fig.2.

2. Mounted on 8.0mm×8.0mm copper pads to each terminal.

3. 8.3ms single half sine-wave, or equivalent square wave, duty cycle=4 pulses per minutes maximum.

**Dimensions (SMC/DO-214AB)**

	Symbol	Millimeters		Inches	
		Min.	Max.	Min.	Max.
L	6.60	7.11	0.260	0.280	
D	5.59	6.22	0.220	0.245	
D1	2.90	3.20	0.114	0.126	
T	7.75	8.13	0.305	0.320	
T1	0.76	1.52	0.030	0.060	
d	-	0.203	-	0.008	
H	2.20	2.80	0.087	0.110	
H1	2.06	2.62	0.079	0.103	

**Electrical Characteristics (T<sub>A</sub>=25°C)**

Part Number		Device Marking Code		Reverse Stand-Off Voltage	Breakdown Voltage @I <sub>T</sub>	Test Current	Maximum Clamping Voltage @I <sub>PP</sub>	Peak Pulse Current	Reverse Leakage @V <sub>RWM</sub>
Unidirectional	Bidirectional	UNI	BI	V <sub>RWM</sub> (V)	V <sub>BR</sub> (V)	I <sub>T</sub> (mA)	V <sub>C</sub> (V)	I <sub>PP</sub> (A)	I <sub>R</sub> (μA)
1.5SMC6.8A-AT	1.5SMC6.8CA-AT	6V8A	6V8C	5.80	6.45~7.14	10	10.5	144.8	1000
1.5SMC7.5A-AT	1.5SMC7.5CA-AT	7V5A	7V5C	6.40	7.13~7.88	10	11.3	134.5	500
1.5SMC8.2A-AT	1.5SMC8.2CA-AT	8V2A	8V2C	7.02	7.79~8.61	10	12.1	125.6	200
1.5SMC9.1A-AT	1.5SMC9.1CA-AT	9V1A	9V1C	7.78	8.65~9.55	1	13.4	113.4	50
1.5SMC10A-AT	1.5SMC10CA-AT	10A	10C	8.55	9.50~10.50	1	14.5	104.8	10
1.5SMC11A-AT	1.5SMC11CA-AT	11A	11C	9.40	10.50~11.60	1	15.6	97.4	5
1.5SMC12A-AT	1.5SMC12CA-AT	12A	12C	10.20	11.40~12.60	1	16.7	91.0	5
1.5SMC13A-AT	1.5SMC13CA-AT	13A	13C	11.10	12.40~13.70	1	18.2	83.5	1
1.5SMC15A-AT	1.5SMC15CA-AT	15A	15C	12.80	14.30~15.80	1	21.2	71.7	1
1.5SMC16A-AT	1.5SMC16CA-AT	16A	16C	13.60	15.20~16.80	1	22.5	67.6	1
1.5SMC18A-AT	1.5SMC18CA-AT	18A	18C	15.30	17.10~18.90	1	25.2	60.3	1
1.5SMC20A-AT	1.5SMC20CA-AT	20A	20C	17.10	19.00~21.00	1	27.7	54.9	1
1.5SMC22A-AT	1.5SMC22CA-AT	22A	22C	18.80	20.90~23.10	1	30.6	49.7	1
1.5SMC24A-AT	1.5SMC24CA-AT	24A	24C	20.50	22.80~25.20	1	33.2	45.8	1
1.5SMC27A-AT	1.5SMC27CA-AT	27A	27C	23.10	25.70~28.40	1	37.5	40.5	1
1.5SMC30A-AT	1.5SMC30CA-AT	30A	30C	25.60	28.50~31.50	1	41.4	36.7	1
1.5SMC33A-AT	1.5SMC33CA-AT	33A	33C	28.20	31.40~34.70	1	45.7	33.3	1
1.5SMC36A-AT	1.5SMC36CA-AT	36A	36C	30.80	34.20~37.80	1	49.9	30.5	1
1.5SMC39A-AT	1.5SMC39CA-AT	39A	39C	33.30	37.10~41.00	1	53.9	28.2	1
1.5SMC43A-AT	1.5SMC43CA-AT	43A	43C	36.80	40.90~45.20	1	59.3	25.6	1

Part Number		Device Marking Code		Reverse Stand-Off Voltage	Breakdown Voltage @ $I_T$	Test Current	Maximum Clamping Voltage @ $I_{PP}$	Peak Pulse Current	Reverse Leakage @ $V_{RWM}$
Unidirectional	Bidirectional	UNI	BI	$V_{RWM}(V)$	$V_{BR}(V)$	$I_T(mA)$	$V_C(V)$	$I_{PP}(A)$	$I_R(\mu A)$
1.5SMC47A-AT	1.5SMC47CA-AT	47A	47C	40.20	44.70~49.40	1	64.8	23.5	1
1.5SMC51A-AT	1.5SMC51CA-AT	51A	51C	43.60	48.50~53.60	1	70.1	21.7	1
1.5SMC56A-AT	1.5SMC56CA-AT	56A	56C	47.80	53.20~58.80	1	77.0	19.7	1
1.5SMC62A-AT	1.5SMC62CA-AT	62A	62C	53.00	58.90~65.10	1	85.0	17.9	1
1.5SMC68A-AT	1.5SMC68CA-AT	68A	68C	58.10	64.60~71.40	1	92.0	16.5	1
1.5SMC75A-AT	1.5SMC75CA-AT	75A	75C	64.10	71.30~78.80	1	103.0	14.8	1
1.5SMC82A-AT	1.5SMC82CA-AT	82A	82C	70.10	77.90~86.10	1	113.0	13.5	1
1.5SMC91A-AT	1.5SMC91CA-AT	91A	91C	77.80	86.50~95.50	1	125.0	12.2	1
1.5SMC100A-AT	1.5SMC100CA-AT	100A	100C	85.50	95.00~105.00	1	137.0	11.1	1
1.5SMC110A-AT	1.5SMC110CA-AT	110A	110C	94.00	105.00~116.00	1	152.0	10.0	1
1.5SMC120A-AT	1.5SMC120CA-AT	120A	120C	102.00	114.00~126.00	1	165.0	9.2	1
1.5SMC130A-AT	1.5SMC130CA-AT	130A	130C	111.00	124.00~137.00	1	179.0	8.5	1
1.5SMC150A-AT	1.5SMC150CA-AT	150A	150C	128.00	143.00~158.00	1	207.0	7.3	1
1.5SMC160A-AT	1.5SMC160CA-AT	160A	160C	136.00	152.00~168.00	1	219.0	6.9	1
1.5SMC170A-AT	1.5SMC170CA-AT	170A	170C	145.00	162.00~179.00	1	234.0	6.5	1
1.5SMC180A-AT	1.5SMC180CA-AT	180A	180C	154.00	171.00~189.00	1	246.0	6.2	1
1.5SMC200A-AT	1.5SMC200CA-AT	200A	200C	171.00	190.00~210.00	1	274.0	5.5	1
1.5SMC220A-AT	1.5SMC220CA-AT	220A	220C	185.00	209.00~231.00	1	328.0	4.6	1
1.5SMC250A-AT	1.5SMC250CA-AT	250A	250C	214.00	237.00~263.00	1	344.0	4.4	1
1.5SMC300A-AT	1.5SMC300CA-AT	300A	300C	256.00	285.00~315.00	1	414.0	3.7	1
1.5SMC350A-AT	1.5SMC350CA-AT	350A	350C	300.00	332.00~368.00	1	482.0	3.2	1
1.5SMC400A-AT	1.5SMC400CA-AT	400A	400C	342.00	380.00~420.00	1	548.0	2.8	1
1.5SMC440A-AT	1.5SMC440CA-AT	440A	440C	376.00	418.00~462.00	1	602.0	2.5	1
1.5SMC480A-AT	1.5SMC480CA-AT	480A	480C	408.00	456.00~504.00	1	658.0	2.3	1
1.5SMC510A-AT	1.5SMC510CA-AT	510A	510C	434.00	485.00~535.00	1	698.0	2.1	1
1.5SMC530A-AT	1.5SMC530CA-AT	530A	530C	450.00	503.50~556.50	1	725.0	2.1	1
1.5SMC540A-AT	1.5SMC540CA-AT	540A	540C	459.00	513.00~567.00	1	740.0	2.0	1
1.5SMC550A-AT	1.5SMC550CA-AT	550A	550C	467.00	522.50~577.50	1	760.0	2.0	1

Notes: For bidirectional type having  $V_{RWM}$  of 10V and less, the  $I_R$  limit is double.

**Ratings and Characteristic Curves ( $T_A=25^\circ\text{C}$  unless otherwise noted)**

**Figure 1. Peak Pulse Power Rating Curve**

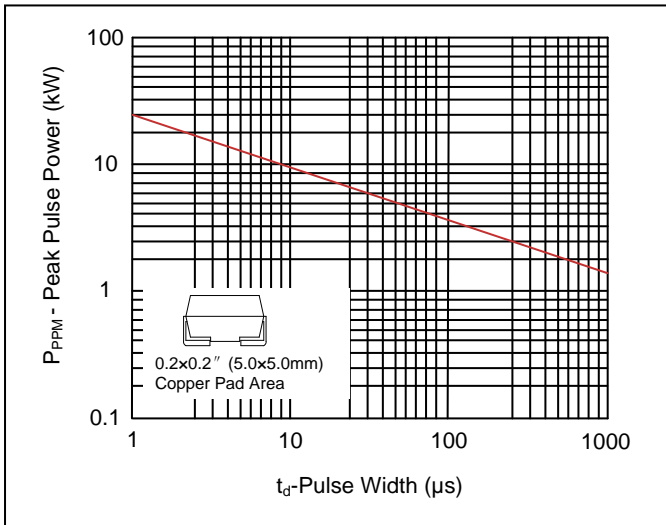

**Figure 2. Pulse Derating Curve**

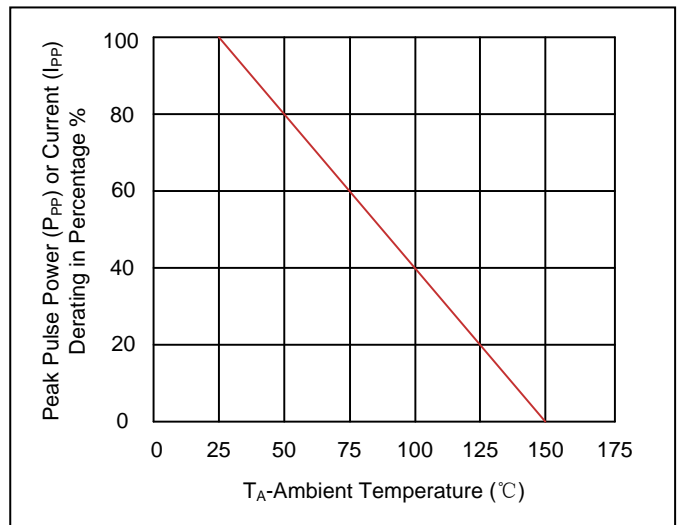

**Figure 3. Pulse Waveform**

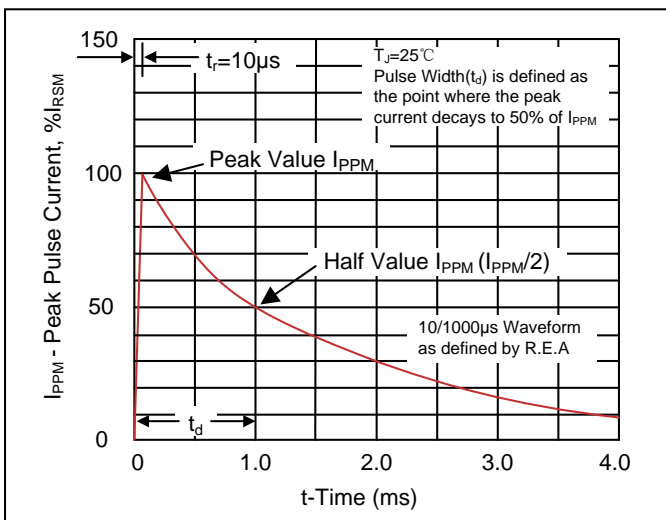

**Figure 4. Typical Junction Capacitance**

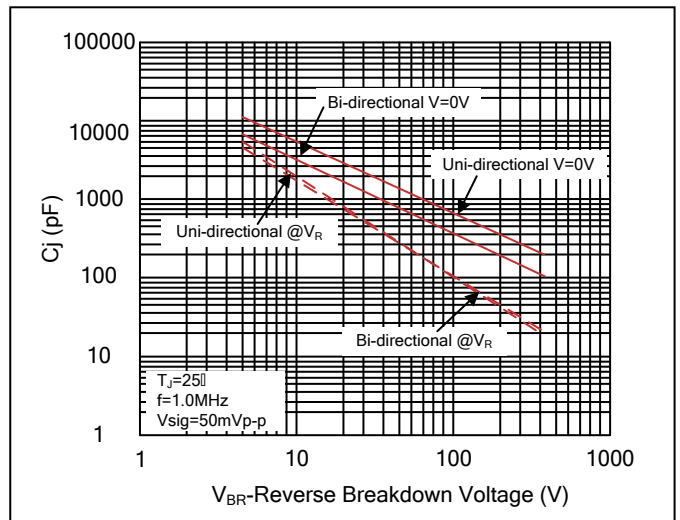

**Figure 5. Steady State Power Dissipation Derating Curve**

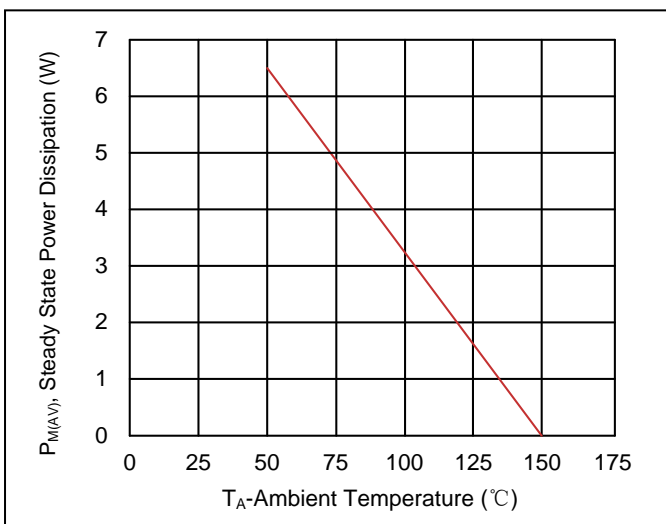

**Figure 6. Maximum Non-Repetitive Forward Surge Current Uni-Directional Only**

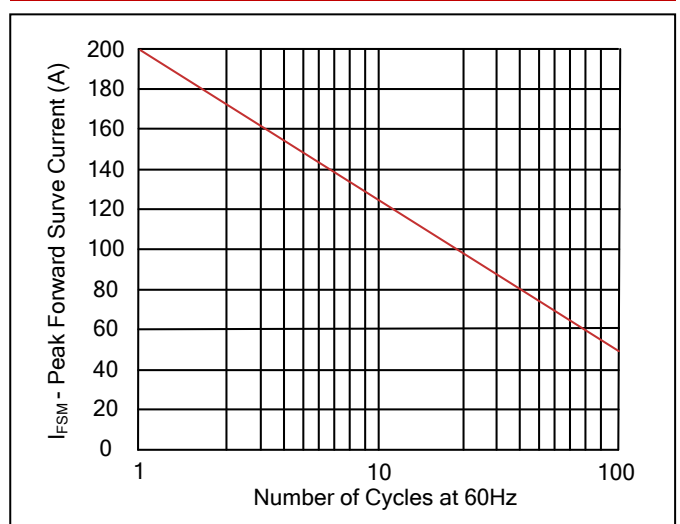

**Recommended Soldering Conditions**

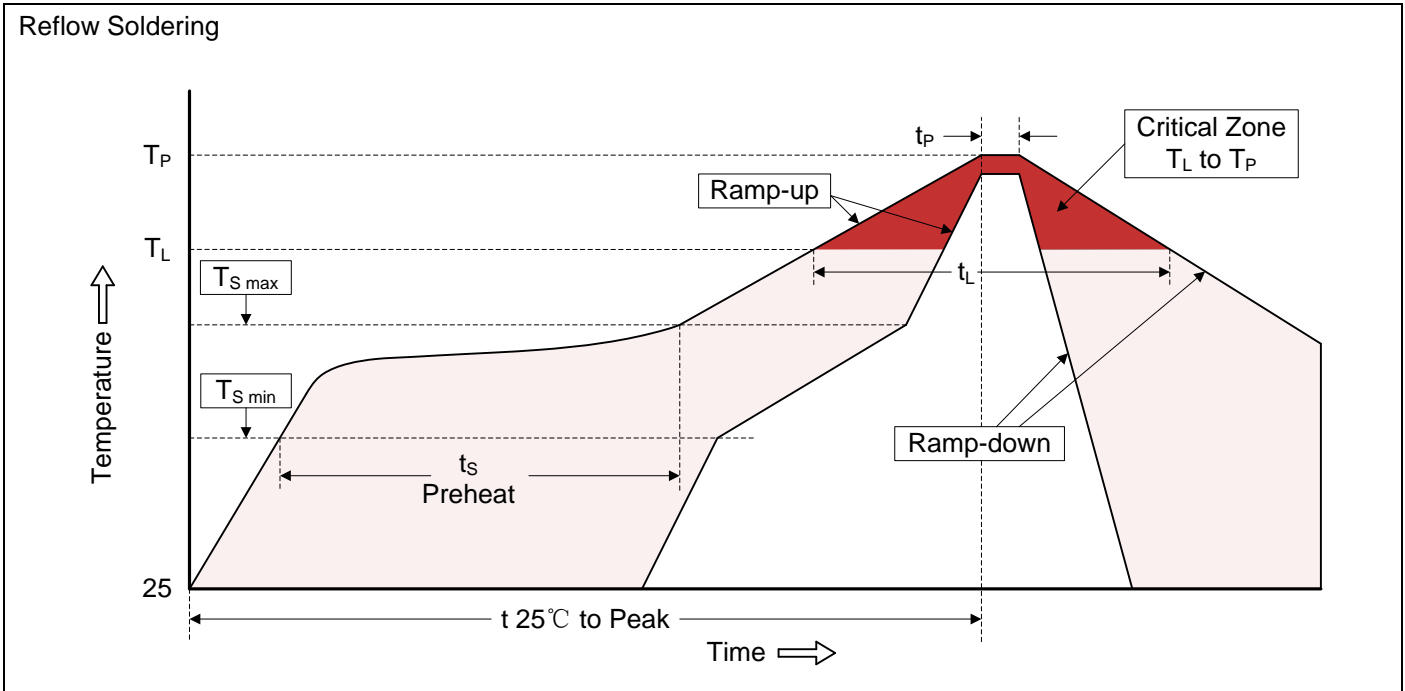

Recommended Conditions

Profile Feature	Pb-Free Assembly
Average ramp-up rate ( $T_L$ to $T_P$ )	3°C/second max.
Preheat -Temperature Min ( $T_{S\ min}$ ) -Temperature Max ( $T_{S\ max}$ ) -Time (min to max) ( $t_s$ )	150°C 200°C 60-180 seconds
$T_{S\ max}$ to $T_L$ -Ramp-up Rate	3°C/second max.
Time maintained above: -Temperature ( $T_L$ ) -Time ( $t_L$ )	217°C 60-150 seconds
Peak Temperature ( $T_P$ )	260°C
Time within 5°C of actual Peak Temperature ( $t_p$ )	20-40 seconds
Ramp-down Rate	6°C/second max.
Time 25°C to Peak Temperature	8 minutes max.

**Marking Code**

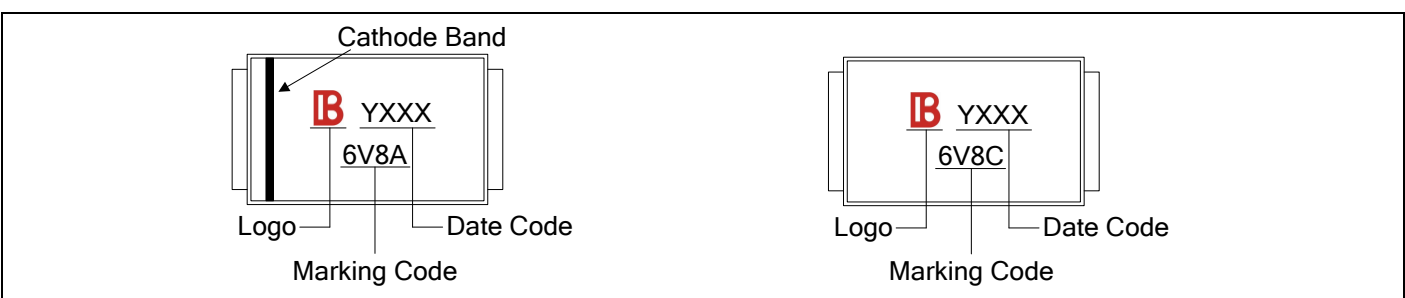

**Part Number Code**

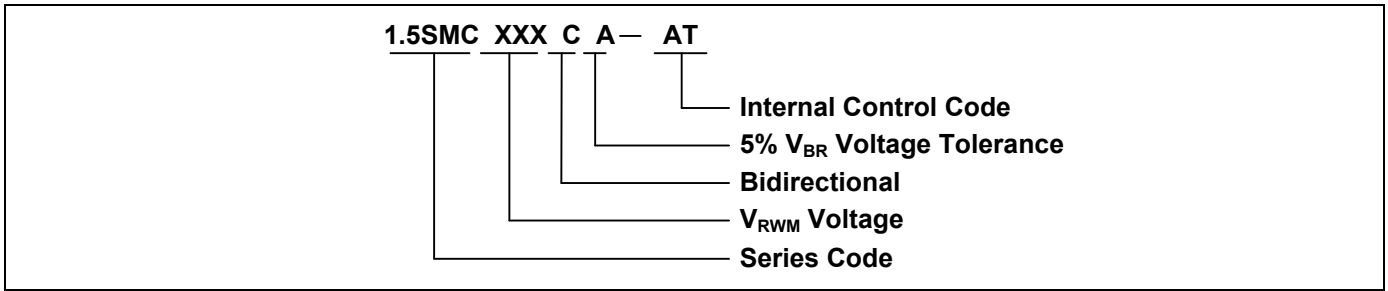

**Ordering Code for Different Package**

7 inch reel package: Add suffix "/7" at the end of the part number, such as 1.5SMC47A-AT/7

13 inch reel package: Add suffix "/13" at the end of the part number, such as 1.5SMC250CA-AT/13

**Packaging**

Tape		Symbol	Dimension (mm)
		W	16.00±0.20
		P0	4.00±0.10
		P1	8.00±0.10
		P2	2.00±0.10
		D0	Φ1.5±0.10
		D1	Φ1.5±0.10
		E	1.75±0.10
		F	7.50±0.10
		A0	6.27±0.15
		B0	8.30±0.10
		K0	3.15±0.15
		T	0.30±0.05
		D2	Φ178.0±2.0
		D3	Φ50.0Min.
		D4	Φ13.0±0.5
W1	20.0±2.0		
		Quantity: 500PCS	
7" Reel		D5	Φ330.0±2.0
		D6	Φ13.5±0.5
		H	2.5±1.0
		W2	20.0±2.0
		Quantity: 3000PCS	
13" Reel			