

1-350766-6 ✓ ACTIVE

MATE-N-LOK | Universal MATE-N-LOK

TE Internal #: 1-350766-6

Rectangular Power Connectors, Housing, Plug, Wire-to-Board /  
Wire-to-Wire, 3 Position, 6.35 mm [.25 in] Centerline, Wire & Cable,  
Universal MATE-N-LOK

[View on TE.com >](#)



Connectors > Power Connectors > Rectangular Power > Rectangular Power Connectors

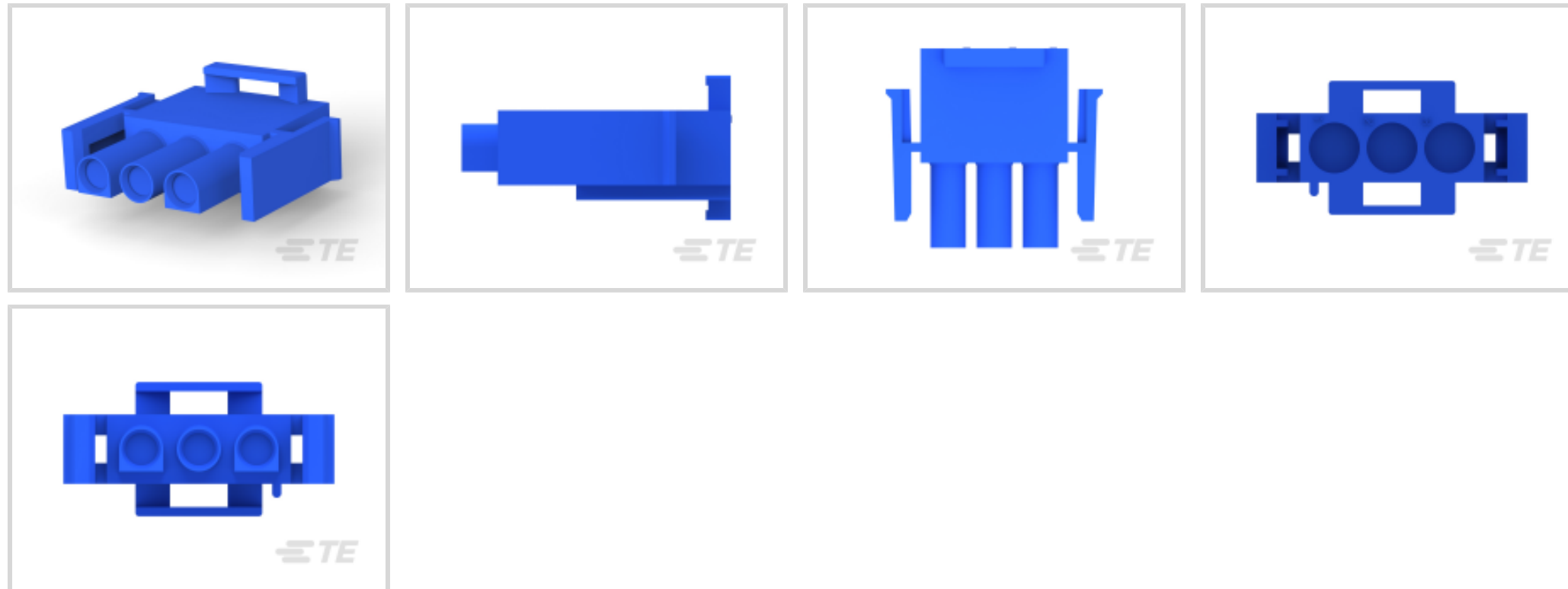

Rectangular Power Connector Type: **Housing**

Connector & Housing Type: **Plug**

Connector System: **Wire-to-Board, Wire-to-Wire**

Number of Positions: **3**

Centerline (Pitch): **6.35 mm [.25 in]**

## Features

### Product Type Features

Rectangular Power Connector Type	Housing
Connector & Housing Type	Plug
Connector System	Wire-to-Board, Wire-to-Wire
Sealable	No
Connector & Contact Terminates To	Wire & Cable

### Configuration Features

Number of Positions	3
Number of Rows	1

### Electrical Characteristics

Operating Voltage	600 VDC
-------------------	---------

### Contact Features

Multiple Contact Types	Without
Contact Layout	Inline
Contact Retention Within Housing	Without



Contact Type	Socket
--------------	--------

### Termination Features

Termination Method to Wire & Cable	Crimp
------------------------------------	-------

### Mechanical Attachment

Connector Mounting Type	Cable Mount (Free-Hanging)
-------------------------	----------------------------

### Housing Features

Centerline (Pitch)	6.35 mm [.25 in]
--------------------	------------------

Housing Color	Blue
---------------	------

Housing Material	Nylon
------------------	-------

### Usage Conditions

Operating Temperature Range	-55 - 105 °C [-67 - 221 °F]
-----------------------------	-----------------------------

### Operation/Application

Circuit Application	Power & Signal
---------------------	----------------

### Industry Standards

CSA Rating	Certified, LR 16455
------------	---------------------

UL Rating	Recognized
-----------	------------

Compatible With Agency/Standards Products	VDE
---	-----

Compatible With Approved Standards Products	UL E28476
---	-----------

UL Flammability Rating	UL 94V-0
------------------------	----------

Glow Wire Rating	Standard Part - Not Glow Wire
------------------	-------------------------------

### Packaging Features

Packaging Quantity	1
--------------------	---

Packaging Method	Package
------------------	---------

### Product Compliance

[For compliance documentation, visit the product page on TE.com>](#)

EU RoHS Directive 2011/65/EU	Compliant
------------------------------	-----------

EU ELV Directive 2000/53/EC	Compliant
-----------------------------	-----------

China RoHS 2 Directive MIIT Order No 32, 2016	No Restricted Materials Above Threshold
---	---

EU REACH Regulation (EC) No. 1907/2006	Current ECHA Candidate List: JAN 2024 (240) Candidate List Declared Against: JAN 2024 (240)
--	--



Does not contain REACH SVHC

Halogen Content

Low Halogen - Br, Cl, F, I < 900 ppm per homogenous material. Also BFR/CFR/PVC Free

Solder Process Capability

Not applicable for solder process capability

Product Compliance Disclaimer

This information is provided based on reasonable inquiry of our suppliers and represents our current actual knowledge based on the information they provided. This information is subject to change. The part numbers that TE has identified as EU RoHS compliant have a maximum concentration of 0.1% by weight in homogenous materials for lead, hexavalent chromium, mercury, PBB, PBDE, DBP, BBP, DEHP, DIBP, and 0.01% for cadmium, or qualify for an exemption to these limits as defined in the Annexes of Directive 2011/65/EU (RoHS2). Finished electrical and electronic equipment products will be CE marked as required by Directive 2011/65/EU. Components may not be CE marked. Additionally, the part numbers that TE has identified as EU ELV compliant have a maximum concentration of 0.1% by weight in homogenous materials for lead, hexavalent chromium, and mercury, and 0.01% for cadmium, or qualify for an exemption to these limits as defined in the Annexes of Directive 2000/53/EC (ELV). Regarding the REACH Regulation, the information TE provides on SVHC in articles for this part number is based on the latest European Chemicals Agency (ECHA) 'Guidance on requirements for substances in articles' posted at this URL: <https://echa.europa.eu/guidance-documents/guidance-on-reach>

## Compatible Parts



TE Part # 640309-6  
UMNL PIN 12-10 AU/PHBZ



TE Part # 926902-3  
UNIV-MNL SPLIT ST



TE Part # 350550-7  
UMNL SOK 20-14 AU/BR L/P



TE Part # 350690-3  
UMNL PIN 24-18 PTPPHBZ L/P



TE Part # 350689-7  
UMNL SOK 24-18 AUBR L/P



TE Part # 350547-7  
UMNL PIN 20-14 AUBR L/P



TE Part # 350689-2  
UMNL SOK 24-18 AUBR L/P



TE Part # 640310-3  
UMNL SOK 12-10 PTPPHBZ



TE Part # 350689-3  
UMNL SOK 24-18 PTPPHBZ L/P



TE Part # 350690-7  
UMNL PIN 24-18 AUBR L/P



TE Part # 350689-1  
UMNL SOK 24-18 PTPBR L/P



TE Part # 926893-3  
UNIV-M-N-L-SOCKET



## Also in the Series | Universal MATE-N-LOK

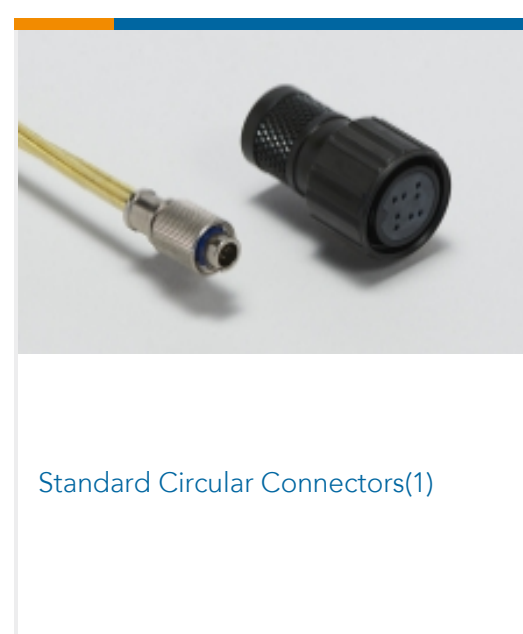
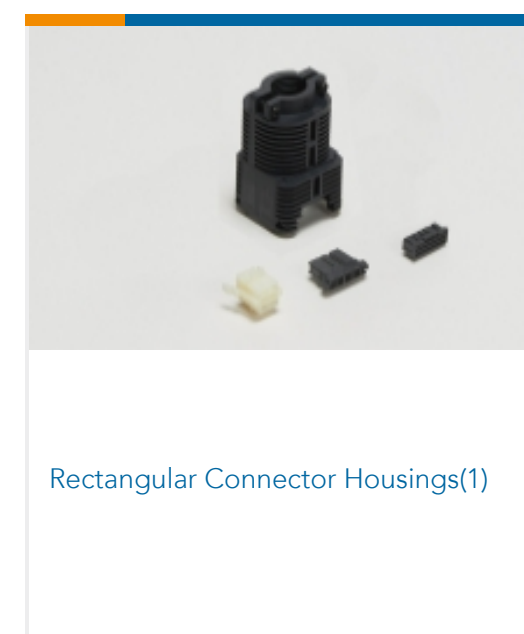
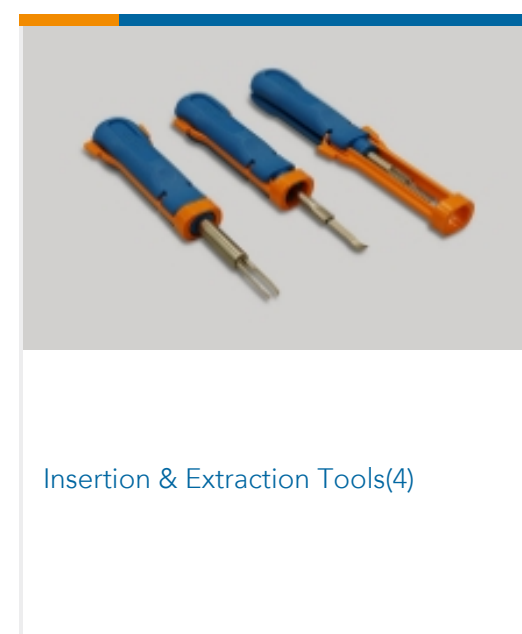
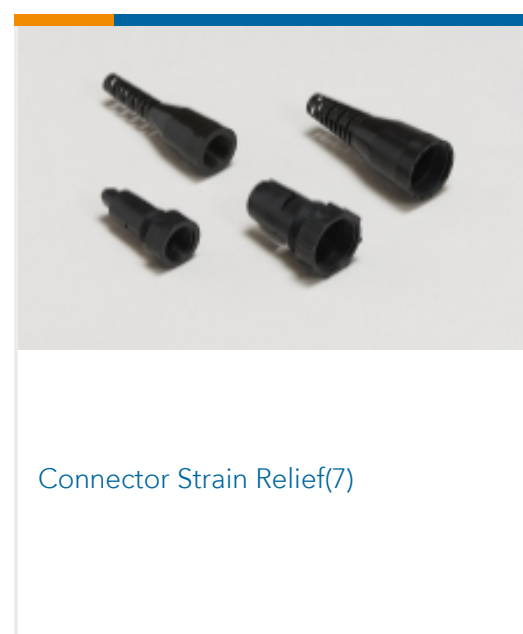
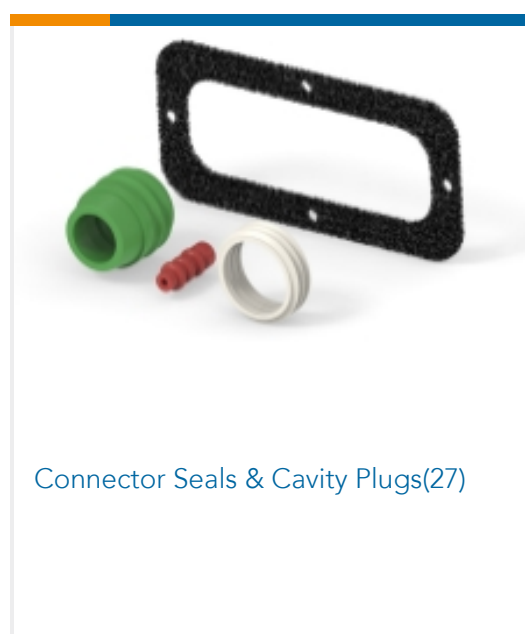
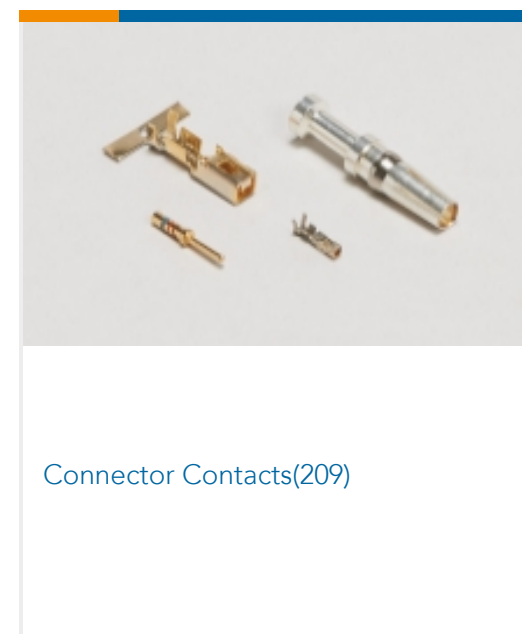
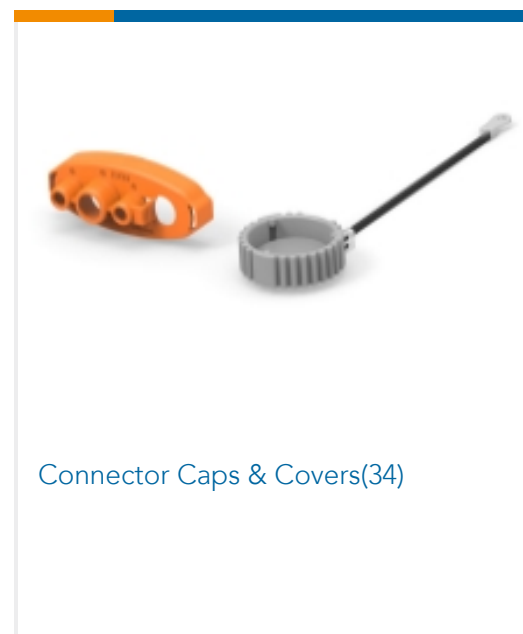
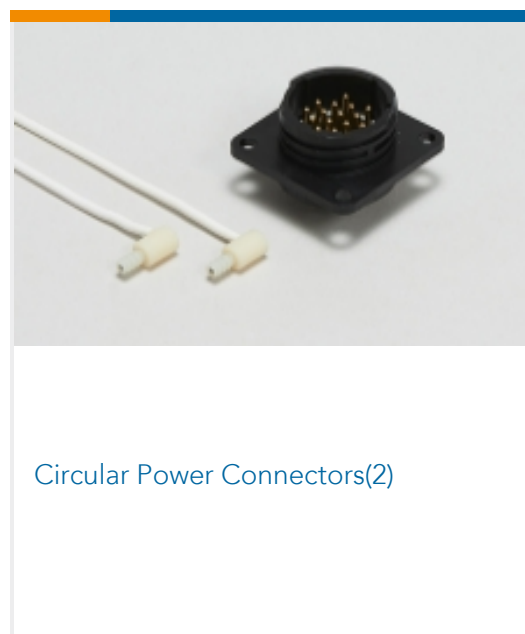

## Customers Also Bought

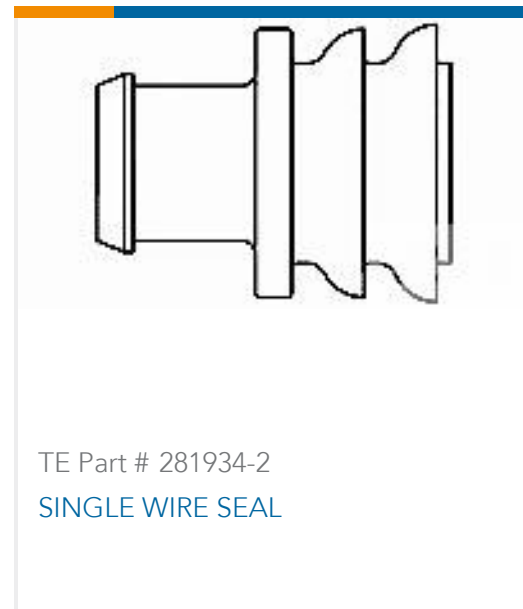

## Documents

### Product Drawings

[03P UMNL V0 PLUG HSG BLUE](#)

English

[03P UMNL V0 PLUG HSG BLUE](#)

English

### CAD Files

[3D PDF](#)

3D

Customer View Model

[ENG\\_CVM\\_CVM\\_1-350766-6\\_AW.2d\\_dxf.zip](#)

English

Customer View Model

[ENG\\_CVM\\_CVM\\_1-350766-6\\_AW.3d\\_igs.zip](#)

English

Customer View Model

[ENG\\_CVM\\_CVM\\_1-350766-6\\_AW.3d\\_stp.zip](#)

English

[3D PDF](#)

English

Customer View Model

[ENG\\_CVM\\_1-350766-6\\_Y2.2d\\_dxf.zip](#)

English

Customer View Model

[ENG\\_CVM\\_1-350766-6\\_Y2.3d\\_igs.zip](#)

English



### Customer View Model

[ENG\\_CVM\\_1-350766-6\\_Y2.3d\\_stp.zip](#)

English

By downloading the CAD file I accept and agree to the [Terms and Conditions](#) of use.

### Datasheets & Catalog Pages

[SOFT\\_SHELL\\_PIN\\_SOCKET\\_CONNECTORS\\_STANDARD\\_DENSITY](#)

English

### Product Specifications

[Application Specification](#)

English

### Instruction Sheets

[Instruction Sheet \(U.S.\)](#)

English