



[Power Versa-Lock](#) | [Power Versa-Lock 5.0](#)

TE Internal #: 1-2378159-3

Power Versa-Lock 5.0, Rectangular Power Connectors, Housing, Plug, Wire-to-Wire, 3 Position, 5mm [.197in] Centerline, Sealable, Wire & Cable, UL 94V-0

[View on TE.com >](#)

Connectors > Power Connectors > Rectangular Power > Rectangular Power Connectors

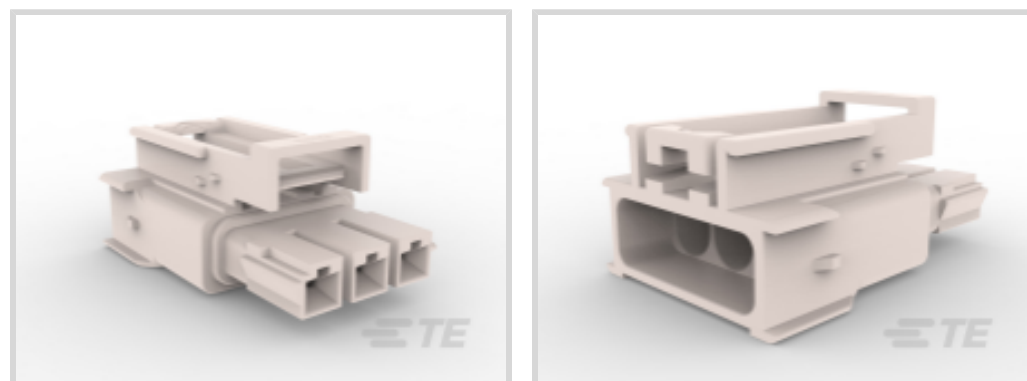

Rectangular Power Connector Type: **Housing**

Connector & Housing Type: **Plug**

Connector System: **Wire-to-Wire**

Number of Positions: **3**

Centerline (Pitch): **5 mm [.197 in]**

Features

Product Type Features

Rectangular Power Connector Type	Housing
Connector & Housing Type	Plug
Connector System	Wire-to-Wire
Sealable	Yes
Connector & Contact Terminates To	Wire & Cable

Configuration Features

Number of Columns	3
Number of Positions	3
Keying	A
Seal Type	Interfacial Seal
Number of Power Positions	3
Number of Rows	1

Electrical Characteristics

Operating Voltage	600 VDC
-------------------	---------

Contact Features

Contact Layout	In-line
Contact Retention Within Housing	Without



Contact Type	Receptacle
--------------	------------

Termination Features

Termination Method to Wire & Cable	Crimp
------------------------------------	-------

Housing Features

Centerline (Pitch)	5 mm [.197 in]
--------------------	----------------

Housing Color	Natural
---------------	---------

Housing Material	PBT GF
------------------	--------

Cable Exit Angle	Straight
------------------	----------

Usage Conditions

Operating Temperature Range	-30 – 140 °C [-22 – 284 °F]
-----------------------------	-----------------------------

Operation/Application

Circuit Application	Power
---------------------	-------

Identification Marking

Circuit Identification Feature	With
--------------------------------	------

Industry Standards

UL Flammability Rating	UL 94V-0
------------------------	----------

Glow Wire Rating	Standard Part - Not Glow Wire
------------------	-------------------------------

Agency/Standard Number	E28476
------------------------	--------

Agency/Standard	UL
-----------------	----

Packaging Features

Packaging Method	Carton
------------------	--------

Other

For Use With	Cap, Receptacle, Seals, TPA
--------------	-----------------------------

Product Compliance

[For compliance documentation, visit the product page on TE.com>](#)

EU RoHS Directive 2011/65/EU	Compliant
------------------------------	-----------

EU ELV Directive 2000/53/EC	Not Yet Reviewed
-----------------------------	------------------

China RoHS 2 Directive MIIT Order No 32, 2016	No Restricted Materials Above Threshold
---	---

EU REACH Regulation (EC) No. 1907/2006	Current ECHA Candidate List: JAN 2021 (211) Candidate List Declared Against: JAN 2021 (211)
--	--



Does not contain REACH SVHC

Halogen Content

Not Low Halogen - contains Br or Cl > 900 ppm.

Solder Process Capability

Not reviewed for solder process capability

Product Compliance Disclaimer

This information is provided based on reasonable inquiry of our suppliers and represents our current actual knowledge based on the information they provided. This information is subject to change. The part numbers that TE has identified as EU RoHS compliant have a maximum concentration of 0.1% by weight in homogenous materials for lead, hexavalent chromium, mercury, PBB, PBDE, DBP, BBP, DEHP, DIBP, and 0.01% for cadmium, or qualify for an exemption to these limits as defined in the Annexes of Directive 2011/65/EU (RoHS2). Finished electrical and electronic equipment products will be CE marked as required by Directive 2011/65/EU. Components may not be CE marked. Additionally, the part numbers that TE has identified as EU ELV compliant have a maximum concentration of 0.1% by weight in homogenous materials for lead, hexavalent chromium, and mercury, and 0.01% for cadmium, or qualify for an exemption to these limits as defined in the Annexes of Directive 2000/53/EC (ELV). Regarding the REACH Regulation, the information TE provides on SVHC in articles for this part number is based on the latest European Chemicals Agency (ECHA) 'Guidance on requirements for substances in articles' posted at this URL: <https://echa.europa.eu/guidance-documents/guidance-on-reach>

Compatible Parts



TE Part # 1-2378158-3
Power Versa-Lock CAP, 1X3 KEY A

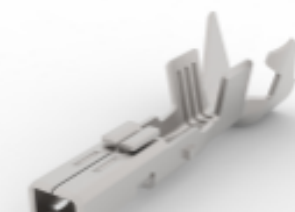

TE Part # 2329916-1
Power Versa-Lock SEAL RECPT, 14-16 AWG



TE Part # 2329914-1
Power Versa-Lock SEAL RECPT, 18-20 AWG



TE Part # 2329915-1
Power Versa-Lock RECPT, 22-26 AWG



TE Part # 2329912-1
Power Versa-Lock RECPT, 18-20, 2X22 AWG



TE Part # 2325347-3
Power Versa-Lock INTERFACE SEAL, 1X3

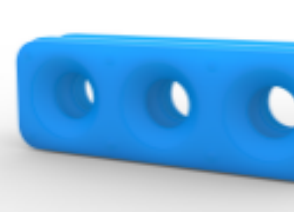

TE Part # 2325349-3
Power Versa-Lock REAR SEAL, 1X3, LargeID



TE Part # 2334614-3
Power Versa-Lock BACK COVER 3P



TE Part # 2334614-2
Power Versa-Lock BACK COVER 2P



TE Part # 2325349-2
Power Versa-Lock REAR SEAL, 1X2, LargeID



TE Part # 2325347-2
Power Versa-Lock INTERFACE SEAL, 1X2



TE Part # 2329016-3
PWR VERSA-LOCK TPA, 1X3

Also in the Series | **Power Versa-Lock 5.0**



Insertion & Extraction Tools(2)

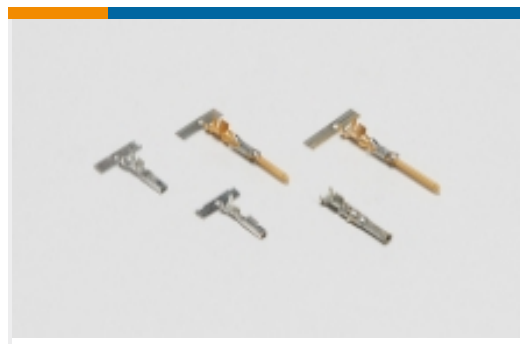

Power Contacts(8)



Rectangular Caps & Covers(3)



Rectangular Connector Locking(1)

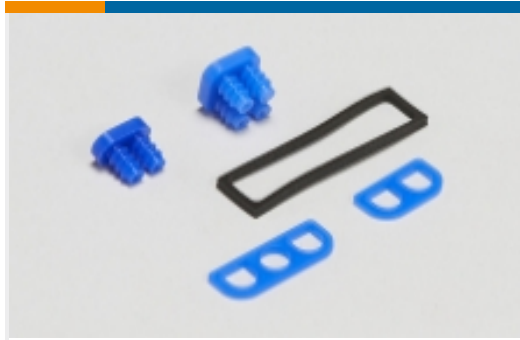

Rectangular Connector Seals(6)



Rectangular Power Connectors(33)

Customers Also Bought

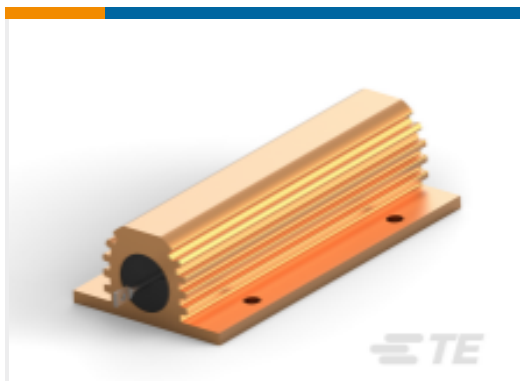

TE Part #3-1630027-2
Power Resistors: Aluminum Housed, HSC



TE Part #1735482-2
Free Height Receptacle Conn: Board-Board, Vertical, 60, 0.8mm



TE Part #1614770-4
Resistor Power BDS2A250

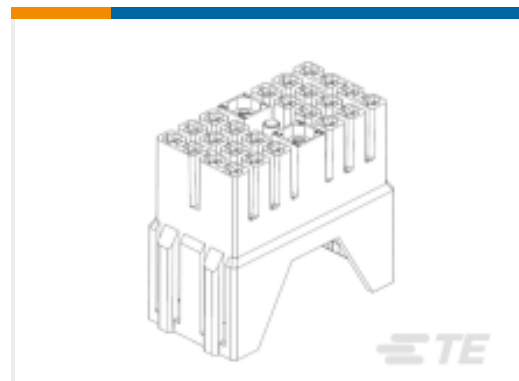

TE Part #284874-1
24 POS PLUG HOUSING ASS'Y



TE Part #4-1393243-2
RT423024



TE Part #55992-1
AMPPOWER TERMINAL 2 STUD HOLES



TE Part #DT06-6S-P004
DEUTSCH DT Series Housings & Connectors



TE Part #1241390-2
AMP MCP, RECEPTACLE AND TAB



TE Part #ASA158F12390235000
623 PLUG



TE Part #ZPF000000000205388
CONTACT FEMALE CAL.20, M12 - FXP

Documents



Product Drawings

[Power Versa-Lock PLUG, 1X3 KEY A](#)

English

Product Specifications

[Application Specification](#)

English

Instruction Sheets

[Instruction Sheet \(U.S.\)](#)

English

Agency Approvals

[UL Report](#)

English