



DEUTSCH | DEUTSCH DT

TE Internal #: 1-2303815-2

Housing for Female Terminals, Wire-to-Wire, 2 Position, .215 in [5.46 mm] Centerline, Sealable, Gray, Wire & Cable, Power & Signal, DEUTSCH DT

[View on TE.com >](#)

Connectors > Automotive Connectors > Automotive Housings

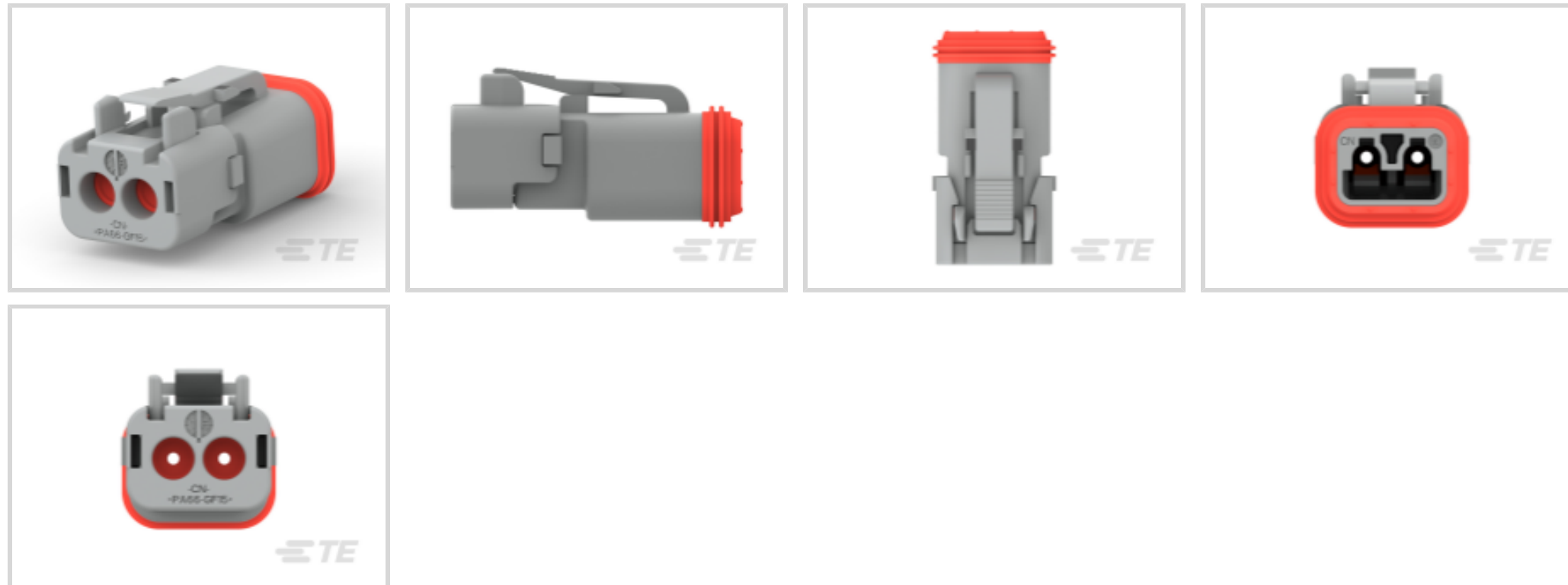

Connector & Housing Type: **Housing for Female Terminals**

Mating Pin Diameter: **1.59 mm [ .063 in ]**

Connector System: **Wire-to-Wire**

Number of Positions: **2**

Centerline (Pitch): **5.46 mm [ .215 in ]**

## Features

### Product Type Features

Connector Shape	Rectangular
Connector & Housing Type	Housing for Female Terminals
Connector System	Wire-to-Wire
Sealable	Yes
Hybrid Connector	No
Primary Locking Feature	Integrated in Housing
Connector & Contact Terminates To	Wire & Cable

### Configuration Features

Blank Cavity Position	0
Number of Positions	2
Number of Rows	1

### Electrical Characteristics

Operating Voltage	250 VAC
Nominal Voltage Architecture	12 V, 24 V, 48 V



### Body Features

Cable Exit Angle	180°
Primary Product Color	Gray

### Contact Features

Contact Size	Size 16
Contact Type	Socket
Mating Pin Diameter	1.59 mm[.063 in]
Contact Current Rating (Max)	13 A

### Mechanical Attachment

Terminal Position Assurance	Yes
Strain Relief	Add By Accessory
Mating Alignment Type	Polarized
Mating Alignment	With
Connector Mounting Type	Cable Mount (Free-Hanging)

### Housing Features

Housing Material	PA GF
Centerline (Pitch)	5.46 mm[.215 in]

### Dimensions

Connector Height	15.77 mm[.621 in]
Product Width	16.48 mm[.649 in]
Product Length	31.2 mm[1.228 in]
Accepts Wire Insulation Diameter Range	2.23 – 3.68 mm[.088 – .145 in]

### Usage Conditions

Operating Temperature (Max)	125 °C[257 °F]
Operating Temperature Range	-55 – 125 °C[-67 – 257 °F]

### Operation/Application

Circuit Application	Power & Signal
---------------------	----------------

### Industry Standards

Degree of Protection	IP68, IP6K9K
Agency/Standard	SAE J2030
UL Flammability Rating	12mm Flame Test per Standard UL-94



### Packaging Features

Packaging Quantity	1600
Packaging Method	Box

### Other

Serviceable	Yes
Connector Position Assurance Capable	No

### Product Compliance

[For compliance documentation, visit the product page on TE.com>](#)

EU RoHS Directive 2011/65/EU	Compliant
EU ELV Directive 2000/53/EC	Compliant
China RoHS 2 Directive MIIT Order No 32, 2016	No Restricted Materials Above Threshold
EU REACH Regulation (EC) No. 1907/2006	Current ECHA Candidate List: JAN 2023 (233) Candidate List Declared Against: JAN 2023 (233) Does not contain REACH SVHC
Halogen Content	Not Low Halogen - contains Br or Cl > 900 ppm.
Solder Process Capability	Not reviewed for solder process capability

#### Product Compliance Disclaimer

This information is provided based on reasonable inquiry of our suppliers and represents our current actual knowledge based on the information they provided. This information is subject to change. The part numbers that TE has identified as EU RoHS compliant have a maximum concentration of 0.1% by weight in homogenous materials for lead, hexavalent chromium, mercury, PBB, PBDE, DBP, BBP, DEHP, DIBP, and 0.01% for cadmium, or qualify for an exemption to these limits as defined in the Annexes of Directive 2011/65/EU (RoHS2). Finished electrical and electronic equipment products will be CE marked as required by Directive 2011/65/EU. Components may not be CE marked. Additionally, the part numbers that TE has identified as EU ELV compliant have a maximum concentration of 0.1% by weight in homogenous materials for lead, hexavalent chromium, and mercury, and 0.01% for cadmium, or qualify for an exemption to these limits as defined in the Annexes of Directive 2000/53/EC (ELV). Regarding the REACH Regulation, the information TE provides on SVHC in articles for this part number is based on the latest European Chemicals Agency (ECHA) 'Guidance on requirements for substances in articles' posted at this URL: <https://echa.europa.eu/guidance-documents/guidance-on-reach>

### Compatible Parts



TE Part # CAT-D48-SP729  
DEUTSCH Sealing Plugs



TE Part # CAT-D48-ST273  
DEUTSCH Solid Contacts



TE Part # CAT-J41-DDRC  
DEUTSCH DT Receptacle Connectors



TE Part # 1011-344-0205  
DUST CAP, 2P, PLG, BLK, DT



TE Part # CAT-D487-W416  
DEUTSCH DT Wedgelocks



TE Part # 776363-1  
SEALING PLUG, SZ 16 CAVITY



TE Part # DT-RT1  
EXT TOOL, FRONT RELEASE



TE Part # CAT-D487-H342  
DEUTSCH DT Headers



TE Part # CAT-D48-SFT273  
DEUTSCH Stamped and Formed Contacts



TE Part # 0462-006-1631  
SOC, SOLID, SIZE 16, 20-24AWG, AU



TE Part # DTF13-2PB  
HDR, 2P, BLK, RA, SN/NI/CU, B

Also in the Series | **DEUTSCH DT**



Automotive Connector Caps & Covers (107)

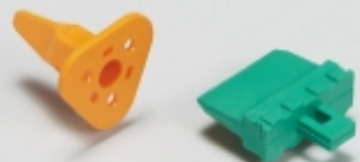

Automotive Connector Locks & Position Assurance(73)



Automotive Housings(586)



Automotive Seals & Cavity Plugs(4)



Insertion & Extraction Tools(3)



Other Automotive Connector Accessories(14)



PCB Headers & Receptacles(102)

Customers Also Bought



## Documents

### Product Drawings

[DT06-2S-TN31, PLG, 2P, GRY, N, SNAPCAP](#)

English

### CAD Files

[3D PDF](#)

3D

Customer View Model

[ENG\\_CVM\\_CVM\\_1-2303815-2\\_A.2d\\_dxf.zip](#)

English

Customer View Model

[ENG\\_CVM\\_CVM\\_1-2303815-2\\_A.3d\\_igs.zip](#)

English

Customer View Model

[ENG\\_CVM\\_CVM\\_1-2303815-2\\_A.3d\\_stp.zip](#)

English

By downloading the CAD file I accept and agree to the [Terms and Conditions](#) of use.

## Product Specifications



### Application Specification

English

---

### Agency Approvals

#### UL Report

English