

1-1969591-3 ✓ ACTIVE



Economy Power 2.5

TE Internal #: 1-1969591-3

Housing, Receptacle, Wire-to-Wire / Wire-to-Panel, 13 Position, 2.5 mm [.098 in] Centerline, Crimp, 1 Row, Natural, Economy Power 2.5

[View on TE.com >](#)

Connectors > PCB Connectors > Wire-to-Board Connectors > Wire-to-Board Connector Assemblies & Housings



Connector Product Type: **Housing**

Connector & Housing Type: **Receptacle**

Connector System: **Wire-to-Panel, Wire-to-Wire**

Number of Positions: **13**

Centerline (Pitch): **2.5 mm [.098 in]**

Features

Product Type Features

Connector Product Type	Housing
Connector & Housing Type	Receptacle
Connector System	Wire-to-Panel, Wire-to-Wire
Sealable	No
Connector & Contact Terminates To	Wire & Cable

Configuration Features

Number of Positions	13
Number of Rows	1

Electrical Characteristics

Operating Voltage	250 VAC
-------------------	---------

Contact Features

Contact Type	Pin
Contact Current Rating (Max)	7.5 A

Termination Features



Termination Method to Wire & Cable	Crimp
------------------------------------	-------

Mechanical Attachment

Strain Relief	Without
---------------	---------

Panel Mount Feature	With
---------------------	------

PCB Mount Retention	Without
---------------------	---------

Mating Retention Type	Latch
-----------------------	-------

Mating Retention	With
------------------	------

Connector Mounting Type	Panel Mount
-------------------------	-------------

Housing Features

Housing Entry Configuration	Both Ends Closed
-----------------------------	------------------

Housing Material	Nylon - GF
------------------	------------

Centerline (Pitch)	2.5 mm [.098 in]
--------------------	------------------

Housing Color	Natural
---------------	---------

Dimensions

Connector Length	35 mm [1.378 in]
------------------	------------------

Connector Height	6.6 mm [.26 in]
------------------	-----------------

Connector Width	18.17 mm [.715 in]
-----------------	--------------------

Accepts Wire Insulation Diameter Range	1.3 – 1.7 mm [.051 – .067 in]
--	-------------------------------

Wire Size	.13 – .33 mm ²
-----------	---------------------------

Usage Conditions

Operating Temperature Range	-25 – 105 °C [-13 – 221 °F]
-----------------------------	-----------------------------

Operation/Application

Circuit Application	Power & Signal
---------------------	----------------

Industry Standards

Glow Wire Rating	Glow Wire
------------------	-----------

UL Flammability Rating	UL 94V-0
------------------------	----------

Packaging Features

Packaging Quantity	10000
--------------------	-------

Packaging Method	Bag
------------------	-----

Other

Comment	Panel Mount
---------	-------------

Product Compliance





For compliance documentation, visit the product page on [TE.com](https://www.te.com)>

EU RoHS Directive 2011/65/EU	Compliant
EU ELV Directive 2000/53/EC	Compliant
China RoHS 2 Directive MIIT Order No 32, 2016	No Restricted Materials Above Threshold
EU REACH Regulation (EC) No. 1907/2006	Current ECHA Candidate List: JAN 2023 (233) Candidate List Declared Against: JAN 2023 (233) Does not contain REACH SVHC
Halogen Content	Not Low Halogen - contains Br or Cl > 900 ppm.
Solder Process Capability	Not reviewed for solder process capability

Product Compliance Disclaimer

This information is provided based on reasonable inquiry of our suppliers and represents our current actual knowledge based on the information they provided. This information is subject to change. The part numbers that TE has identified as EU RoHS compliant have a maximum concentration of 0.1% by weight in homogenous materials for lead, hexavalent chromium, mercury, PBB, PBDE, DBP, BBP, DEHP, DIBP, and 0.01% for cadmium, or qualify for an exemption to these limits as defined in the Annexes of Directive 2011/65/EU (RoHS2). Finished electrical and electronic equipment products will be CE marked as required by Directive 2011/65/EU. Components may not be CE marked. Additionally, the part numbers that TE has identified as EU ELV compliant have a maximum concentration of 0.1% by weight in homogenous materials for lead, hexavalent chromium, and mercury, and 0.01% for cadmium, or qualify for an exemption to these limits as defined in the Annexes of Directive 2000/53/EC (ELV). Regarding the REACH Regulation, the information TE provides on SVHC in articles for this part number is based on the latest European Chemicals Agency (ECHA) 'Guidance on requirements for substances in articles' posted at this URL: <https://echa.europa.eu/guidance-documents/guidance-on-reach>

Compatible Parts

 <p>TE Part # 1-1969589-3 HSG, REC, FREE-HANG, GWT, SINGLE ROW, EP2.5</p>	 <p>TE Part # 1969591-4 HSG, REC, PANEL MOUNT, GWT, SINGLE ROW, EP2.5</p>	 <p>TE Part # 1969591-6 HSG, REC, PANEL MOUNT, GWT, SINGLE ROW, EP2.5</p>	 <p>TE Part # 1969591-8 HSG, REC, PANEL MOUNT, GWT, SINGLE ROW, EP2.5</p>
--	---	--	--

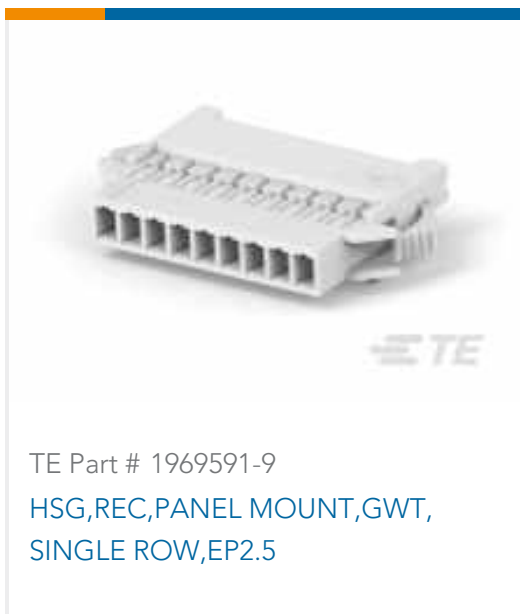
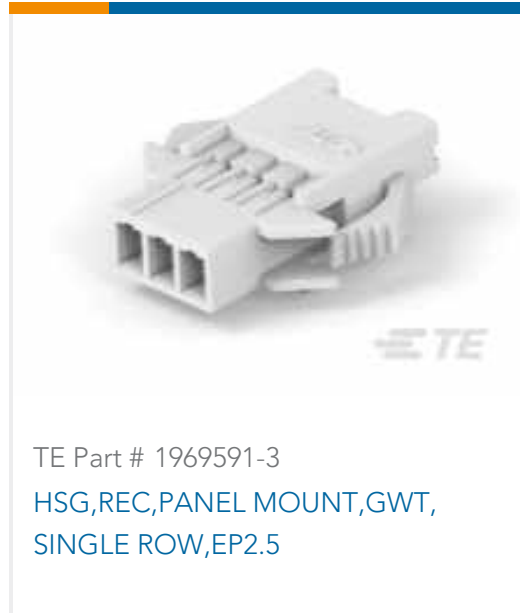

Also in the Series | Economy Power 2.5

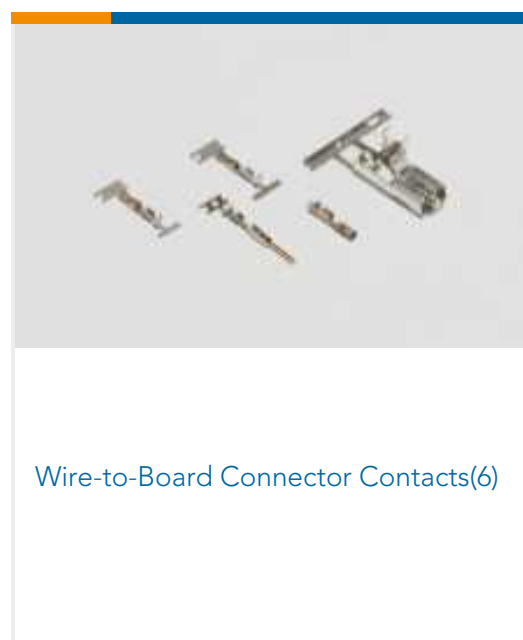
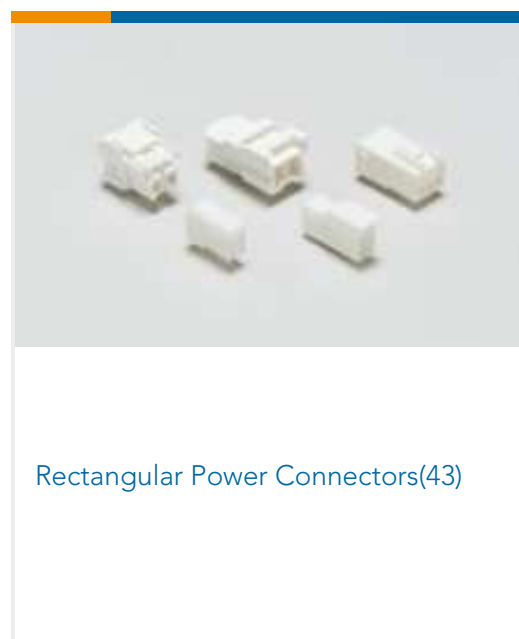
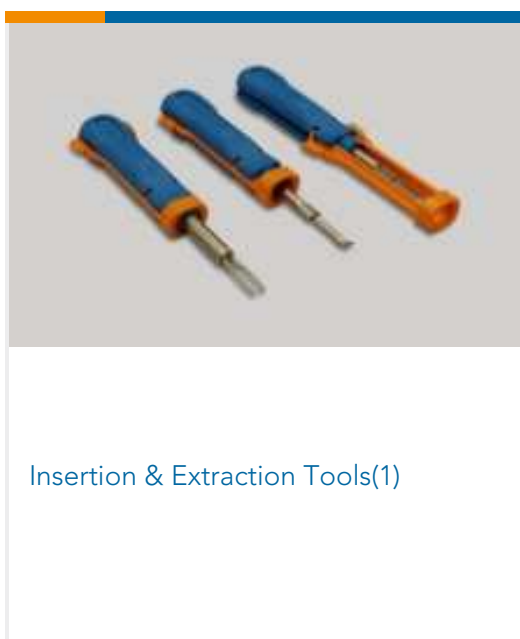

Customers Also Bought

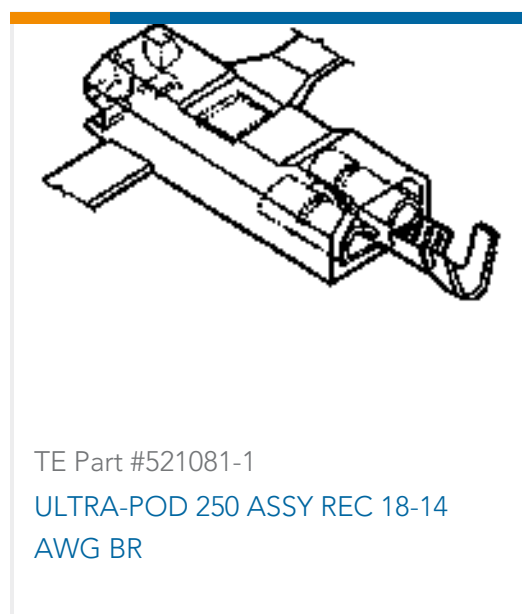

TE Part #521081-1
ULTRA-POD 250 ASSY REC 18-14
AWG BR



TE Part #644267-2
SL156 HSG (YELLOW)



TE Part #1-521253-3
PL MKIII & FASTON 250 HSG 2P
NYLON GREEN



TE Part #1-853088-0
ANVIL

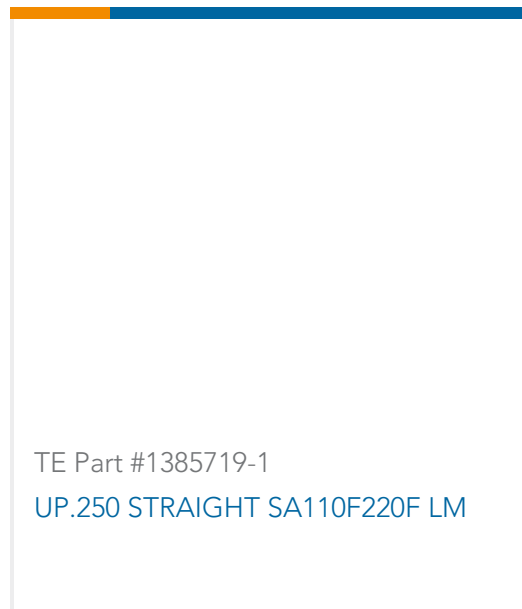

TE Part #1385719-1
UP.250 STRAIGHT SA110F220F LM



TE Part #1852646-1
EFHBPO200TABLOCK.2100 LM/G



TE Part #2-1241817-3
STD TIM HOUSING MKII 3POS



TE Part #440452-000
RT-3-NO.1-0-2.25IN



TE Part #938365P002
VERSAFIT-1/8-0-0.75IN-ST

Documents

Product Drawings

HSG,REC,PANEL MOUNT,GWT,SINGLE ROW,EP2.5

English

CAD Files

3D PDF

3D

Customer View Model

[ENG_CVM_CVM_1-1969591-3_B.2d_dxf.zip](#)

English

Customer View Model

[ENG_CVM_CVM_1-1969591-3_B.3d_igs.zip](#)

English

Customer View Model

[ENG_CVM_CVM_1-1969591-3_B.3d_stp.zip](#)

English

By downloading the CAD file I accept and agree to the [Terms and Conditions](#) of use.

Product Specifications



Application Specification

English

Instruction Sheets

Instruction Sheet (U.S.)

English

Agency Approvals

UL Report

English