

1-1969588-2 ✓ ACTIVE



### Economy Power 2.5

TE Internal #: 1-1969588-2

Housing, Receptacle, Wire-to-Wire, 12 Position, .098 in [2.5 mm]

Centerline, Crimp, 1 Row, Natural, Mating Retention, Wire & Cable,

Economy Power 2.5

[View on TE.com >](#)

Connectors > PCB Connectors > Wire-to-Board Connectors > Wire-to-Board Connector Assemblies & Housings



Connector Product Type: **Housing**

Connector & Housing Type: **Receptacle**

Connector System: **Wire-to-Wire**

Number of Positions: **12**

Centerline (Pitch): **2.5 mm [ .098 in ]**

## Features

### Product Type Features

Connector Product Type	Housing
Connector & Housing Type	Receptacle
Connector System	Wire-to-Wire
Sealable	No
Connector & Contact Terminates To	Wire & Cable

### Configuration Features

Number of Positions	12
Number of Rows	1

### Electrical Characteristics

Operating Voltage	250 VAC
-------------------	---------

### Body Features

Primary Product Color	Natural
-----------------------	---------

### Contact Features

--	--



Contact Type	Pin
Contact Base Material	Brass
Contact Current Rating (Max)	7.5 A

#### Termination Features

Termination Method to Wire & Cable	Crimp
------------------------------------	-------

#### Mechanical Attachment

Strain Relief	Without
Panel Mount Feature	Without
PCB Mount Retention	Without
Mating Retention Type	Latch
Mating Retention	With
Connector Mounting Type	Cable Mount (Free-Hanging)

#### Housing Features

Housing Entry Configuration	Both Ends Closed
Housing Material	Nylon - GF
Centerline (Pitch)	2.5 mm[.098 in]

#### Dimensions

Connector Length	32.5 mm[1.279 in]
Connector Height	6.6 mm[.26 in]
Connector Width	18.17 mm[.715 in]
Compatible Insulation Diameter Range	1.3 – 1.7 mm[.051 – .067 in]
Wire Size	.13 – .33 mm <sup>2</sup>

#### Usage Conditions

Operating Temperature Range	-25 – 105 °C[-13 – 221 °F]
-----------------------------	----------------------------

#### Operation/Application

Circuit Application	Power & Signal
---------------------	----------------

#### Industry Standards

Glow Wire Rating	Standard Part - Not Glow Wire
UL Flammability Rating	UL 94V-0

#### Packaging Features

Packaging Quantity	150
Packaging Method	Bag



Other

Discrete Wire Connector Comment	Free Hanging
---------------------------------	--------------

Product Compliance





[For compliance documentation, visit the product page on TE.com>](#)

EU RoHS Directive 2011/65/EU	Compliant
EU ELV Directive 2000/53/EC	Compliant
China RoHS 2 Directive MIIT Order No 32, 2016	No Restricted Materials Above Threshold
EU REACH Regulation (EC) No. 1907/2006	Current ECHA Candidate List: JUNE 2023 (235) Candidate List Declared Against: JUNE 2023 (235) Does not contain REACH SVHC
Halogen Content	Low Halogen - Br, Cl, F, I < 900 ppm per homogenous material. Also BFR/CFR/PVC Free
Solder Process Capability	Not reviewed for solder process capability

Product Compliance Disclaimer

This information is provided based on reasonable inquiry of our suppliers and represents our current actual knowledge based on the information they provided. This information is subject to change. The part numbers that TE has identified as EU RoHS compliant have a maximum concentration of 0.1% by weight in homogenous materials for lead, hexavalent chromium, mercury, PBB, PBDE, DBP, BBP, DEHP, DIBP, and 0.01% for cadmium, or qualify for an exemption to these limits as defined in the Annexes of Directive 2011/65/EU (RoHS2). Finished electrical and electronic equipment products will be CE marked as required by Directive 2011/65/EU. Components may not be CE marked. Additionally, the part numbers that TE has identified as EU ELV compliant have a maximum concentration of 0.1% by weight in homogenous materials for lead, hexavalent chromium, and mercury, and 0.01% for cadmium, or qualify for an exemption to these limits as defined in the Annexes of Directive 2000/53/EC (ELV). Regarding the REACH Regulation, the information TE provides on SVHC in articles for this part number is based on the latest European Chemicals Agency (ECHA) 'Guidance on requirements for substances in articles' posted at this URL: <https://echa.europa.eu/guidance-documents/guidance-on-reach>

Compatible Parts

 <p>TE Part # 1969588-6 HSG, REC, FREE-HANGING, SINGLE ROW, EP2.5</p>	 <p>TE Part # 1969588-2 HSG, REC, FREE-HANGING, SINGLE ROW, EP2.5</p>	 <p>TE Part # 1969588-5 HSG, REC, FREE-HANGING, SINGLE ROW, EP2.5</p>	 <p>TE Part # 1969588-8 HSG, REC, FREE-HANGING, SINGLE ROW, EP2.5</p>
--	---	--	--





TE Part # 1969588-4  
HSG, REC, FREE-HANGING, SINGLE ROW,EP2.5



TE Part # 1969588-7  
HSG, REC, FREE-HANGING, SINGLE ROW,EP2.5



TE Part # 1969588-3  
HSG, REC, FREE-HANGING, SINGLE ROW,EP2.5



TE Part # 1-1969541-2  
RETAINER, TPA, DUAL ROW, EP2.5



TE Part # 1-1969588-0  
HSG, REC, FREE-HANGING, SINGLE ROW,EP2.5



TE Part # 1-1969588-1  
HSG, REC, FREE-HANGING, SINGLE ROW,EP2.5



TE Part # 1-1969588-4  
HSG, REC, FREE-HANGING, SINGLE ROW,EP2.5



TE Part # 1-1969588-5  
HSG, REC, FREE-HANGING, SINGLE ROW,EP2.5



TE Part # 1969588-9  
HSG, REC, FREE-HANGING, SINGLE ROW,EP2.5



TE Part # 1-1969588-3  
HSG, REC, FREE-HANGING, SINGLE ROW,EP2.5



TE Part # 1-1969589-2  
HSG, REC, FREE-HANG, GWT, SINGLE ROW,EP2.5

Also in the Series | Economy Power 2.5



PCB Headers & Receptacles(494)



PCB Latches, Locks & Retainers(49)



Rectangular Power Connectors(43)



Wire-to-Board Connector Assemblies & Housings(311)



Wire-to-Board Connector Contacts(6)

Customers Also Bought

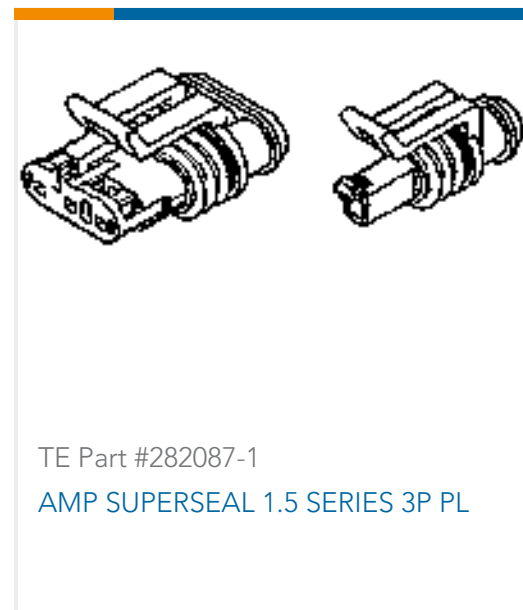

## Documents

### Product Drawings

HSG, REC, FREE-HANGING, SINGLE ROW, EP2.5

English

### CAD Files

3D PDF

3D

Customer View Model

[ENG\\_CVM\\_CVM\\_1-1969588-2\\_B.2d\\_dxf.zip](#)

English

Customer View Model

[ENG\\_CVM\\_CVM\\_1-1969588-2\\_B.3d\\_igs.zip](#)

English

Customer View Model

[ENG\\_CVM\\_CVM\\_1-1969588-2\\_B.3d\\_stp.zip](#)

English

By downloading the CAD file I accept and agree to the [Terms and Conditions](#) of use.

### Product Specifications

Application Specification

English

### Instruction Sheets

Instruction Sheet (U.S.)

English

### Agency Approvals

UL Report

1-1969588-2

Housing, Receptacle, Wire-to-Wire, 12 Position, .098 in [2.5 mm] Centerline, Crimp, 1 Row, Natural, Mating Retention, Wire & Cable, Economy Power 2.5



English