

1-176975-9 ✓ ACTIVE

AMP Universal Power

TE Internal #: 1-176975-9

Header, Plug, Wire-to-Board, 2 Position, 3.96 mm [.155 in]

Centerline, Printed Circuit Board, AMP Universal Power,

Rectangular Power Connectors

[View on TE.com >](#)



Connectors > Power Connectors > Rectangular Power > Rectangular Power Connectors

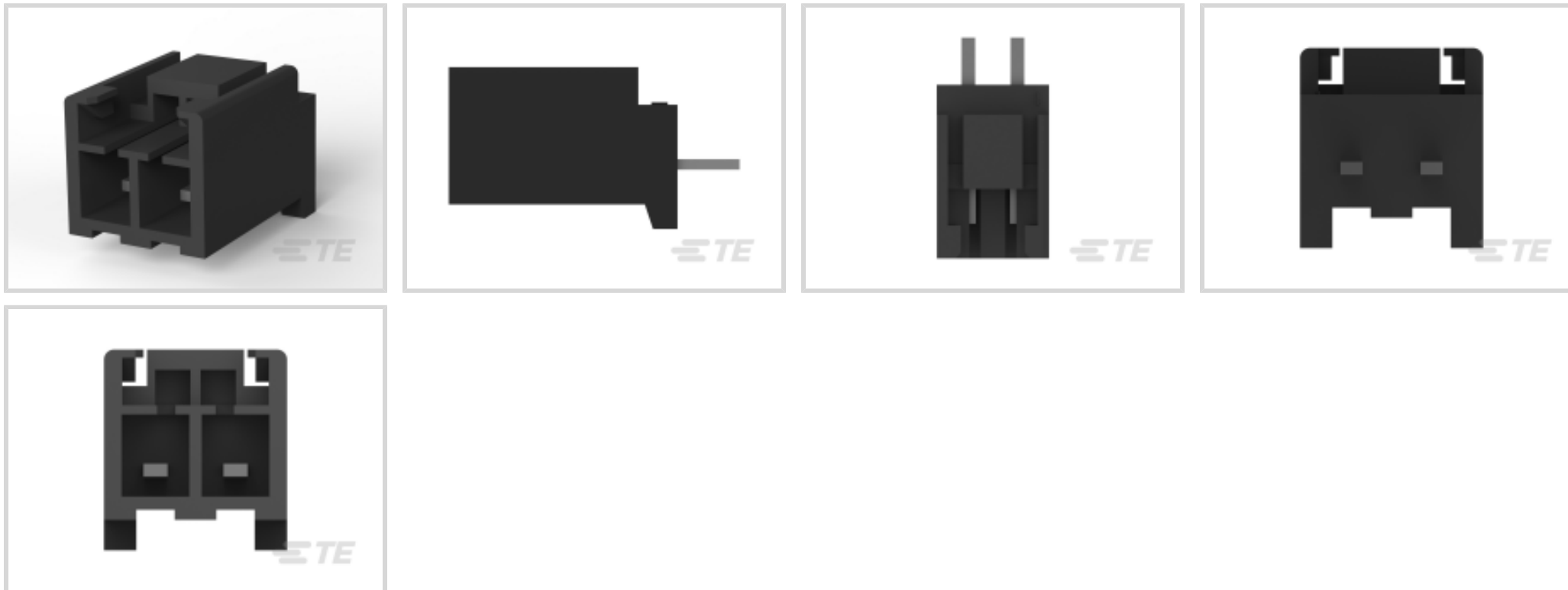

Rectangular Power Connector Type: **Header**

Connector & Housing Type: **Plug**

Connector System: **Wire-to-Board**

Number of Positions: **2**

Centerline (Pitch): **3.96 mm [.155 in]**

Features

Product Type Features

Header Type	Fully Shrouded
Rectangular Power Connector Type	Header
Connector & Housing Type	Plug
Connector System	Wire-to-Board
Sealable	No
Connector & Contact Terminates To	Printed Circuit Board

Configuration Features

Number of Positions	2
PCB Mount Orientation	Vertical
Number of Power Positions	2
Number of Signal Positions	0
Number of Rows	1

Electrical Characteristics

Operating Voltage	50 VAC
-------------------	--------



Contact Features

Contact Mating Area Plating Material	Tin
Contact Current Rating (Max)	7 A
Contact Retention Within Housing	Without
Contact Type	Tab
PCB Contact Termination Area Plating Material	Tin
Contact Mating Area Plating Material Thickness	1 μ m[39.37 μ in]

Termination Features

Termination Method to PCB	Through Hole - Solder
---------------------------	-----------------------

Mechanical Attachment

Connector Mounting Type	Board Mount
-------------------------	-------------

Housing Features

Centerline (Pitch)	3.96 mm[.155 in]
Housing Color	Black
Housing Material	Nylon 6/6 GF

Usage Conditions

Operating Temperature Range	-30 – 105 °C[-22 – 221 °F]
-----------------------------	----------------------------

Operation/Application

Circuit Application	Power
---------------------	-------

Industry Standards

UL Flammability Rating	UL 94V-0
Glow Wire Rating	Standard Part - Not Glow Wire

Packaging Features

Packaging Quantity	400
Packaging Method	Bag & Box

Product Compliance

[For compliance documentation, visit the product page on TE.com>](#)

EU RoHS Directive 2011/65/EU	Compliant
EU ELV Directive 2000/53/EC	Compliant
China RoHS 2 Directive MIIT Order No 32, 2016	No Restricted Materials Above Threshold



EU REACH Regulation (EC) No. 1907/2006

Current ECHA Candidate List: JUNE 2024 (241)

Candidate List Declared Against: JUNE 2024 (241)

Does not contain REACH SVHC

Halogen Content

Not Low Halogen - contains Br or Cl > 900 ppm.

Solder Process Capability

Wave solder capable to 265°C

Product Compliance Disclaimer

This information is provided based on reasonable inquiry of our suppliers and represents our current actual knowledge based on the information they provided. This information is subject to change. The part numbers that TE has identified as EU RoHS compliant have a maximum concentration of 0.1% by weight in homogenous materials for lead, hexavalent chromium, mercury, PBB, PBDE, DBP, BBP, DEHP, DIBP, and 0.01% for cadmium, or qualify for an exemption to these limits as defined in the Annexes of Directive 2011/65/EU (RoHS2). Finished electrical and electronic equipment products will be CE marked as required by Directive 2011/65/EU. Components may not be CE marked. Additionally, the part numbers that TE has identified as EU ELV compliant have a maximum concentration of 0.1% by weight in homogenous materials for lead, hexavalent chromium, and mercury, and 0.01% for cadmium, or qualify for an exemption to these limits as defined in the Annexes of Directive 2000/53/EC (ELV). Regarding the REACH Regulation, the information TE provides on SVHC in articles for this part number is based on the latest European Chemicals Agency (ECHA) 'Guidance on requirements for substances in articles' posted at this URL: <https://echa.europa.eu/guidance-documents/guidance-on-reach>

Compatible Parts

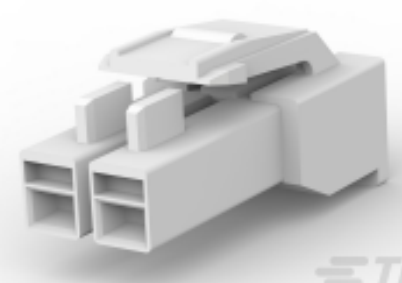

TE Part # 176271-1
AMP UNIVERSAL POWER PLUG 2P

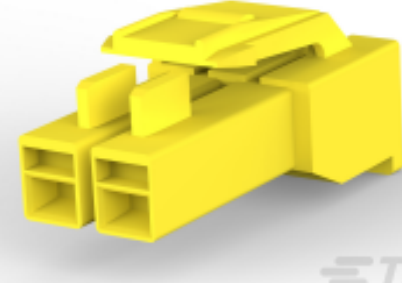

TE Part # 176271-4
AMP UNIVERSAL POWER PLUG 2P



TE Part # 176271-9
AMP UNIVERSAL POWER PLUG 2P

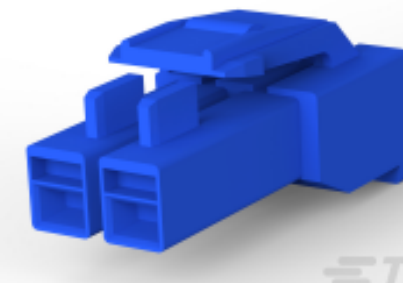

TE Part # 176271-6
AMP UNIVERSAL POWER PLUG 2P

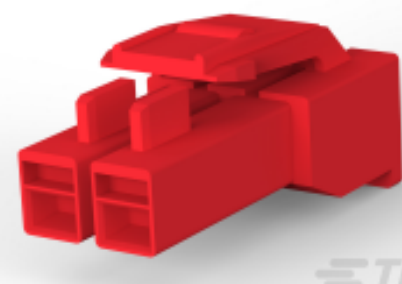

TE Part # 176271-2
AMP UNIVERSAL POWER PLUG 2P

Also in the Series | [AMP Universal Power](#)



Connector Contacts(22)



Insertion & Extraction Tools(1)



Rectangular Power Connectors(163)

Customers Also Bought



TE Part #9-6437287-8
SUPERSEAL Connector Headers: 1.0 mm



TE Part #9-966140-3
AMP MCP Unsealed Headers



TE Part #1-967658-1
8pos MQS .63 header 90deg

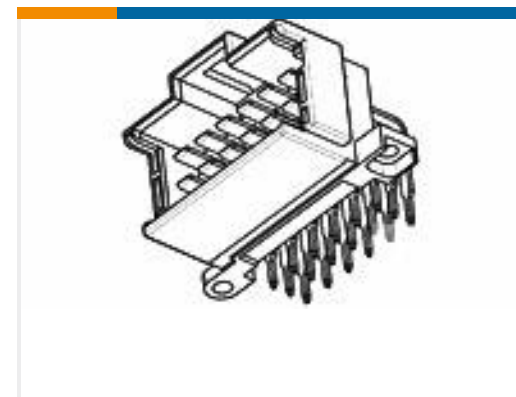

TE Part #3-966140-3
MESSERLEISTE 12P

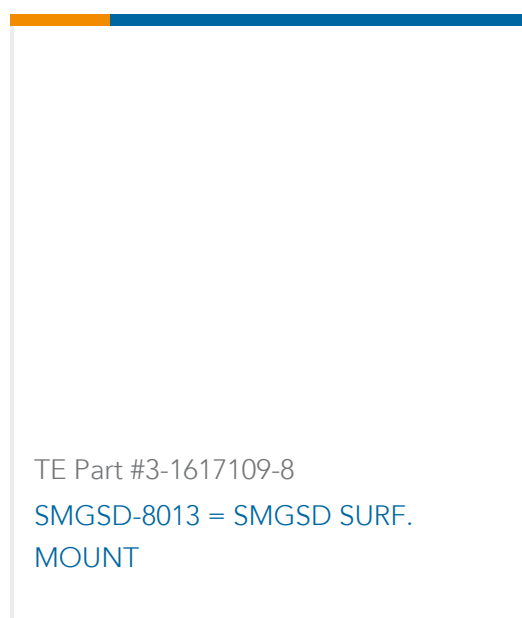

TE Part #3-1617109-8
SMGSD-8013 = SMGSD SURF.
MOUNT

Documents

Product Drawings

UNIV POWER HDR ASSY 2P BLACK

Japanese

CAD Files

3D PDF

3D

Customer View Model

[ENG_CVM_CVM_1-176975-9_F.2d_dxf.zip](#)

English

Customer View Model

[ENG_CVM_CVM_1-176975-9_F.3d_igs.zip](#)

English

Customer View Model

[ENG_CVM_CVM_1-176975-9_F.3d_stp.zip](#)

English

By downloading the CAD file I accept and agree to the [Terms and Conditions](#) of use.



Product Specifications

Crimping of Universal Power Contact

English

Product Specification

Japanese

AMP Universal Power Connector

Japanese

Instruction Sheets

AMP UNIVERSAL POWER CONNECTOR SERIES

English

Instruction Sheet (non U.S.)

English

Agency Approvals

UL Report

English