

1-174928-1 ✓ ACTIVE

AMP | Multilock Connector System

TE Internal #: 1-174928-1

Housing for Male Terminals, Wire-to-Wire, 3 Position, .137 in [3.5 mm] Centerline, Natural (White), Wire & Cable, Multilock Connector System

[View on TE.com >](#)



Connectors > Automotive Connectors > Automotive Housings

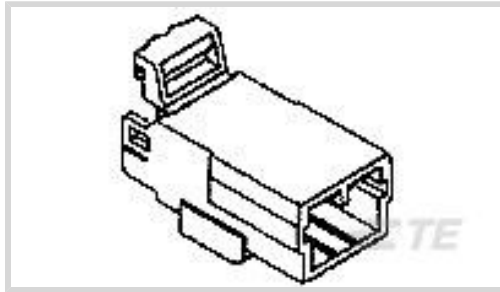

Connector System: **Wire-to-Wire**

Number of Positions: **3**

Connector & Housing Type: **Housing for Male Terminals**

Centerline (Pitch): **3.5 mm [.137 in]**

Sealable: **No**

Features

Product Type Features

Mixed & Hybrid Connector	No
Connector System	Wire-to-Wire
Connector & Housing Type	Housing for Male Terminals
Sealable	No
Connector & Contact Terminates To	Wire & Cable
Primary Locking Feature	Integrated in Housing

Configuration Features

Number of Positions	3
Number of Rows	1

Body Features

Primary Product Color	Natural (White)
-----------------------	-----------------

Contact Features

Mating Tab Width	1.8 mm[.07 in]
------------------	----------------

Mechanical Attachment

Connector Mounting Type	Cable Mount (Free-Hanging)
-------------------------	----------------------------

Housing Features

Centerline (Pitch)	3.5 mm[.137 in]
--------------------	-----------------



Usage Conditions

Operating Temperature (Max)	105 °C[221 °F]
Operating Temperature Range	-30 – 105 °C[-22 – 221 °F]

Other

Connector Position Assurance Capable	No
--------------------------------------	----

Product Compliance

[For compliance documentation, visit the product page on TE.com>](#)

EU RoHS Directive 2011/65/EU	Compliant
EU ELV Directive 2000/53/EC	Compliant
China RoHS 2 Directive MIIT Order No 32, 2016	No Restricted Materials Above Threshold
EU REACH Regulation (EC) No. 1907/2006	Current ECHA Candidate List: JUNE 2024 (241) Candidate List Declared Against: JUNE 2024 (241) Does not contain REACH SVHC
Halogen Content	Not Low Halogen - contains Br or Cl > 900 ppm.
Solder Process Capability	Not applicable for solder process capability

Product Compliance Disclaimer

This information is provided based on reasonable inquiry of our suppliers and represents our current actual knowledge based on the information they provided. This information is subject to change. The part numbers that TE has identified as EU RoHS compliant have a maximum concentration of 0.1% by weight in homogenous materials for lead, hexavalent chromium, mercury, PBB, PBDE, DBP, BBP, DEHP, DIBP, and 0.01% for cadmium, or qualify for an exemption to these limits as defined in the Annexes of Directive 2011/65/EU (RoHS2). Finished electrical and electronic equipment products will be CE marked as required by Directive 2011/65/EU. Components may not be CE marked. Additionally, the part numbers that TE has identified as EU ELV compliant have a maximum concentration of 0.1% by weight in homogenous materials for lead, hexavalent chromium, and mercury, and 0.01% for cadmium, or qualify for an exemption to these limits as defined in the Annexes of Directive 2000/53/EC (ELV). Regarding the REACH Regulation, the information TE provides on SVHC in articles for this part number is based on the latest European Chemicals Agency (ECHA) 'Guidance on requirements for substances in articles' posted at this URL: <https://echa.europa.eu/guidance-documents/guidance-on-reach>

Compatible Parts



Also in the Series | Multilock Connector System

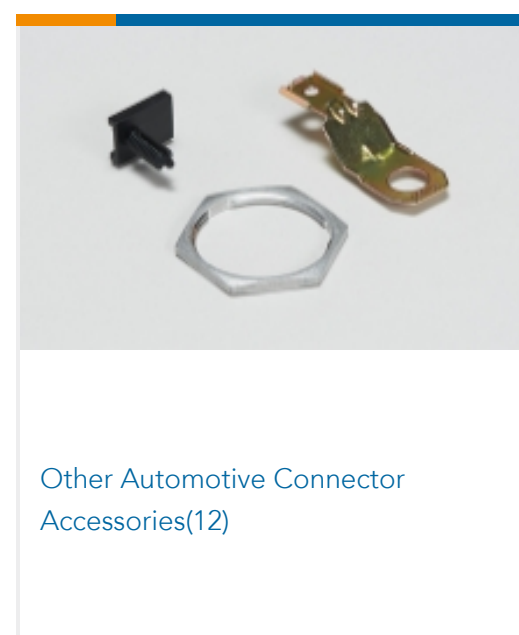
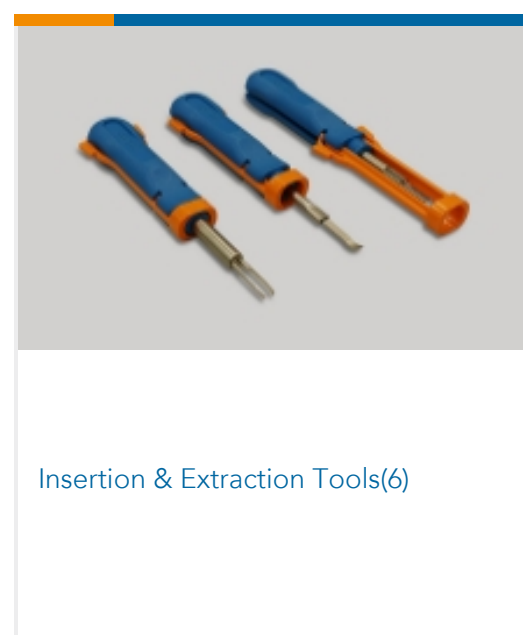
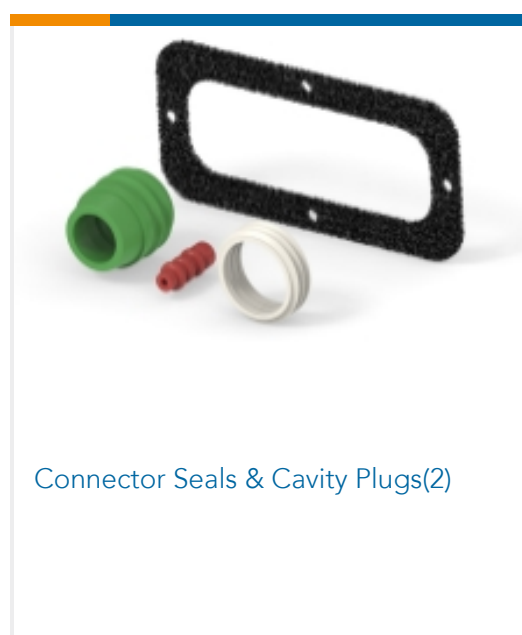
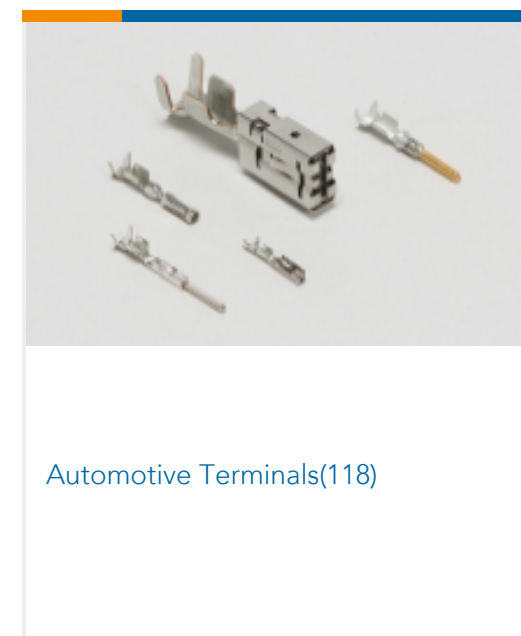
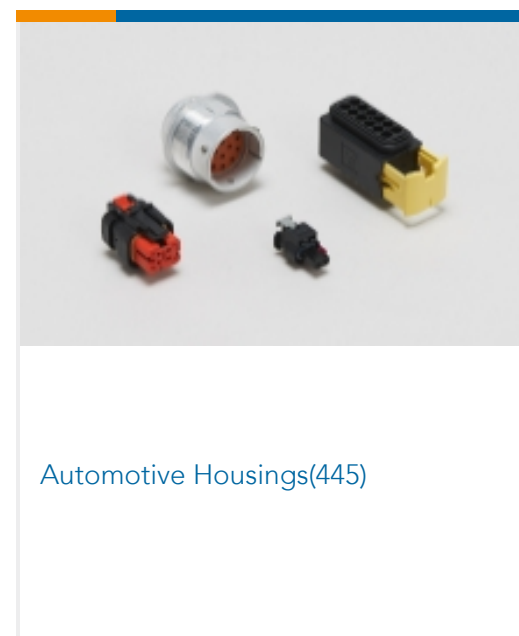
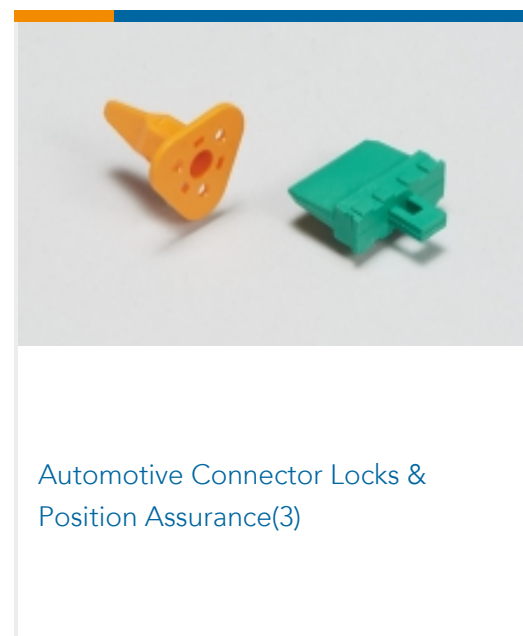
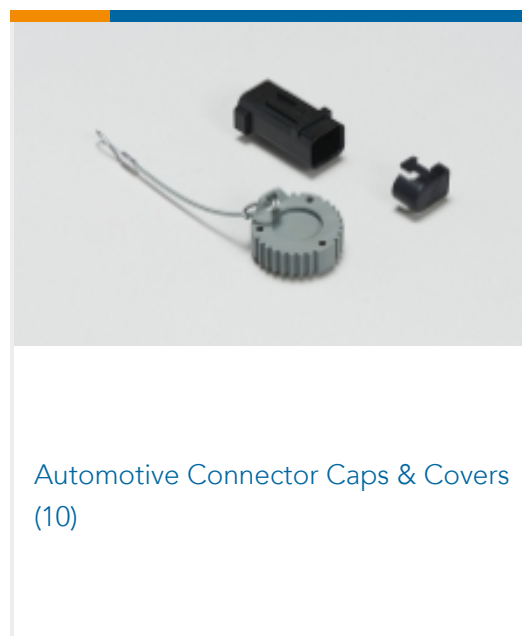

Customers Also Bought

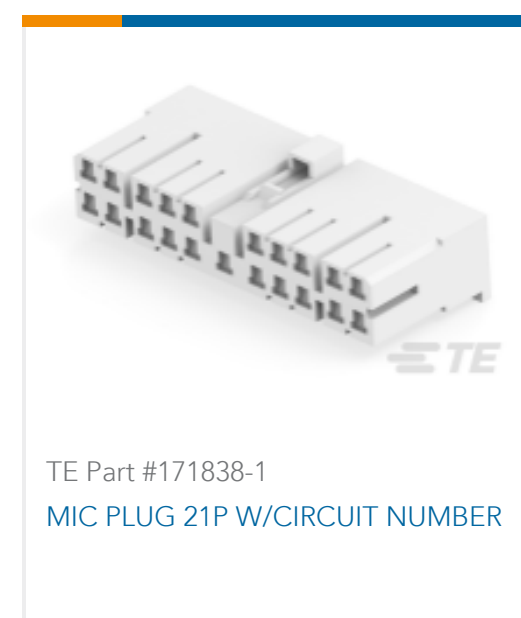
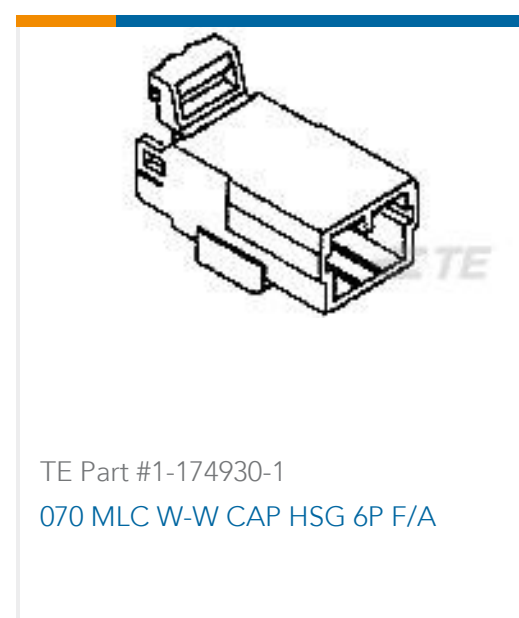

Documents

CAD Files

Customer View Model

[ENG_CVM_1-174928-1_C1.3d_igs.zip](#)

English

Customer View Model

[ENG_CVM_1-174928-1_C1.3d_stp.zip](#)



English

Customer View Model

[ENG_CVM_1-174928-1_C1.2d_dxf.zip](#)

English

3D PDF

English

3D PDF

3D

Customer View Model

[ENG_CVM_CVM_1-174928-1_F.2d_dxf.zip](#)

English

Customer View Model

[ENG_CVM_CVM_1-174928-1_F.3d_igs.zip](#)

English

Customer View Model

[ENG_CVM_CVM_1-174928-1_F.3d_stp.zip](#)

English

By downloading the CAD file I accept and agree to the [Terms and Conditions](#) of use.

Product Specifications

Product Specification

Japanese