

1-172163-9 ✓ ACTIVE

MATE-N-LOK | Mini-Universal MATE-N-LOK

TE Internal #: 1-172163-9

Rectangular Power Connectors, Housing, Receptacle, Wire-to-Wire / Wire-to-Panel, 15 Position, 4.2 mm [.165 in] Centerline, Mini-Universal MATE-N-LOK

[View on TE.com >](#)



Connectors > Power Connectors > Rectangular Power > Rectangular Power Connectors



Rectangular Power Connector Type: **Housing**

Connector & Housing Type: **Receptacle**

Connector System: **Wire-to-Panel, Wire-to-Wire**

Number of Positions: **15**

Centerline (Pitch): **4.2 mm [.165 in]**

Features

Product Type Features

Rectangular Power Connector Type	Housing
Connector & Housing Type	Receptacle
Connector System	Wire-to-Panel, Wire-to-Wire
Sealable	No
Connector & Contact Terminates To	Wire & Cable

Configuration Features

Number of Positions	15
Number of Rows	3

Electrical Characteristics

Operating Voltage	600 VDC
-------------------	---------

Contact Features

Multiple Contact Types	Without
Contact Layout	Matrix
Contact Retention Within Housing	Without



Contact Type	Pin
--------------	-----

Termination Features

Termination Method to Wire & Cable	Crimp
------------------------------------	-------

Mechanical Attachment

Panel Mount Feature	With
---------------------	------

Panel Mount Feature Type	Mounting Ears
--------------------------	---------------

Connector Mounting Type	Panel Mount
-------------------------	-------------

Housing Features

Centerline (Pitch)	4.2 mm [.165 in]
--------------------	------------------

Housing Color	Black
---------------	-------

Housing Material	Nylon 66
------------------	----------

Dimensions

Panel Thickness (Recommended)	.8 – 2 mm [.031 – .078 in]
-------------------------------	----------------------------

Product Width	14.55 mm
---------------	----------

Product Length	27.5 mm
----------------	---------

Row-to-Row Spacing	4.2 mm [.165 in]
--------------------	------------------

Usage Conditions

Operating Temperature Range	-20 – 105 °C [-4 – 221 °F]
-----------------------------	----------------------------

Operation/Application

Circuit Application	Power & Signal
---------------------	----------------

Identification Marking

Circuit Identification Feature	With
--------------------------------	------

Industry Standards

CSA Rating	Certified, LR 7189
------------	--------------------

UL Rating	Recognized
-----------	------------

Compatible With Agency/Standards Products	CSA, UL
---	---------

Compatible With Approved Standards Products	UL E28476
---	-----------

UL Flammability Rating	UL 94V-0
------------------------	----------

Glow Wire Rating	Standard Part - Not Glow Wire
------------------	-------------------------------

Packaging Features

Packaging Quantity	500
--------------------	-----



Packaging Method

Bag

Product Compliance

[For compliance documentation, visit the product page on TE.com>](#)

EU RoHS Directive 2011/65/EU	Compliant
EU ELV Directive 2000/53/EC	Compliant
China RoHS 2 Directive MIIT Order No 32, 2016	No Restricted Materials Above Threshold
EU REACH Regulation (EC) No. 1907/2006	Current ECHA Candidate List: JUNE 2023 (235) Candidate List Declared Against: JUNE 2023 (235) Does not contain REACH SVHC
Halogen Content	Low Halogen - Br, Cl, F, I < 900 ppm per homogenous material. Also BFR/CFR/PVC Free
Solder Process Capability	Not applicable for solder process capability

Product Compliance Disclaimer

This information is provided based on reasonable inquiry of our suppliers and represents our current actual knowledge based on the information they provided. This information is subject to change. The part numbers that TE has identified as EU RoHS compliant have a maximum concentration of 0.1% by weight in homogenous materials for lead, hexavalent chromium, mercury, PBB, PBDE, DBP, BBP, DEHP, DIBP, and 0.01% for cadmium, or qualify for an exemption to these limits as defined in the Annexes of Directive 2011/65/EU (RoHS2). Finished electrical and electronic equipment products will be CE marked as required by Directive 2011/65/EU. Components may not be CE marked. Additionally, the part numbers that TE has identified as EU ELV compliant have a maximum concentration of 0.1% by weight in homogenous materials for lead, hexavalent chromium, and mercury, and 0.01% for cadmium, or qualify for an exemption to these limits as defined in the Annexes of Directive 2000/53/EC (ELV). Regarding the REACH Regulation, the information TE provides on SVHC in articles for this part number is based on the latest European Chemicals Agency (ECHA) 'Guidance on requirements for substances in articles' posted at this URL: <https://echa.europa.eu/guidance-documents/guidance-on-reach>

Compatible Parts

 <p>TE Part # 1-770988-1 MINI UMNL SOK 22-18AWG LP LF</p>	 <p>TE Part # 1-770985-0 MINI UMNL PIN 26-22AWG AU LP</p>	 <p>TE Part # 1-770987-0 MINI UMNL PIN 22-18 AWG AU LP</p>	 <p>TE Part # 770988-3 MINI UMNL SOK 22-18AWG AU LP</p>
--	---	---	--



TE Part # 1-770988-0
MINI UMNL SOK 22-18AWG AU



TE Part # 1-794059-0
MINI UMNL PIN L/P LF



TE Part # 770988-1
MINI UMNL SOK 22-18AWG SN LP



TE Part # 770986-1
MINI UMNL SOK 26-22AWG SN LP



TE Part # 794058-1
MINI UMNL SOK L/P



TE Part # 170365-3
MINI UNIVERSAL M-N-L SOCKET LP



TE Part # 170364-3
MINI UNIVERSAL M-N-L PIN LP



TE Part # 770985-1
MINI UMNL PIN 26-22AWG SN LP



TE Part # 1-794407-1
MINI UMNL SOK 20-16 AWG AU LF



TE Part # 170363-3
MINI UNIVERSAL M-N-L PIN LP



TE Part # 171638-1
MINI U-M-N-L PIN CONT. L.P



TE Part # 171639-1
MINI U-M-N-L SOCKET L.P



TE Part # 770903-3
MINI UMNL PIN 22-18 AWG AU



TE Part # 170366-3
MINI UNIVERSAL M-N-L SOCKET LP



TE Part # 794059-1
MINI UMNL PIN L/P



TE Part # 170364-1
MINI UNIVERSAL M-N-L PIN LP

Also in the Series | Mini-Universal MATE-N-LOK



Connector Caps & Covers(2)



Connector Contacts(92)



Connector Hardware(4)



Connector Seals & Cavity Plugs(17)



Connector Strain Relief(2)

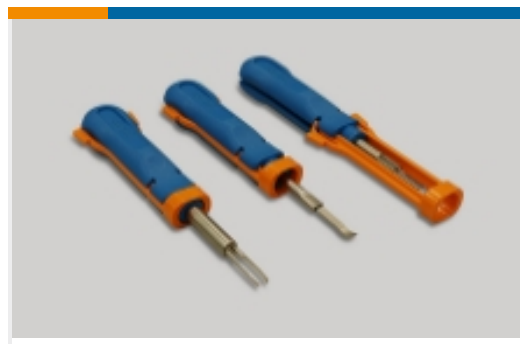

Insertion & Extraction Tools(1)

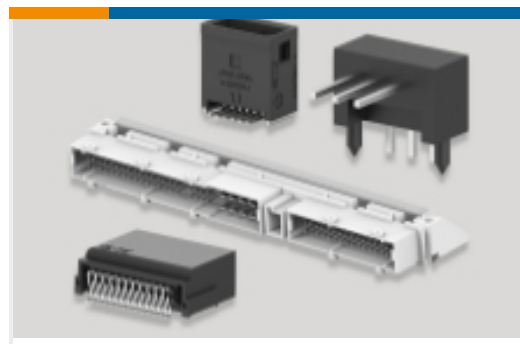

PCB Headers & Receptacles(1)



Rectangular Power Connectors(197)

Customers Also Bought



TE Part #206305-1
CPC PLUG ASSEMBLY SIZE 23-37



TE Part #5748676-2
DIE CAST CBL CLMP KIT,SZ 2

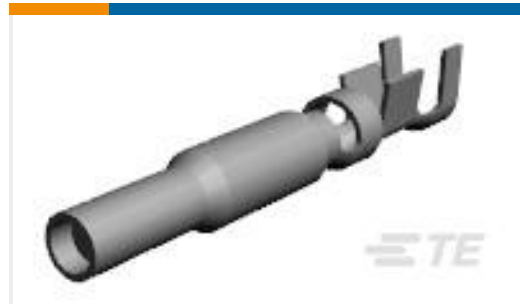

TE Part #770251-3
UMNL II SOK PTPPHBZ LP 20-14



TE Part #770028-1
09P UMNLII IN-LINE CAP HSG KIT



TE Part #177907-1
POWER DBL LOCK CAP P/M 3P



TE Part #1586856-1
02P UMNL CAP HSG, GW



TE Part #176497-1
POSITIVE LOCK .250 Hsg (6.3 MM) V2

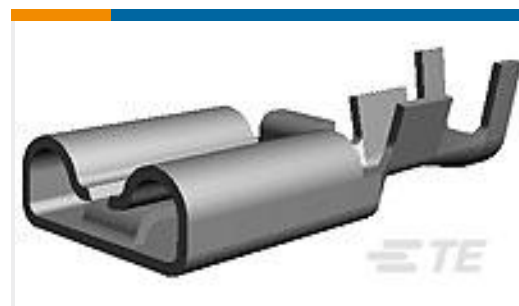

TE Part #175020-1
250 PL EX REC. 22-18AWG PTBR



TE Part #170325-5
187 PL MKII REC. 20-16AWG PTBR

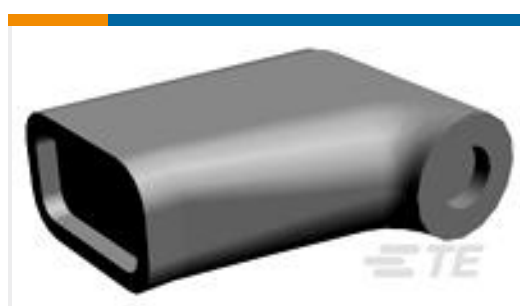

TE Part #170891-1
250 FASTON HSG.,FLAG,REC., NATRUAL

Documents

CAD Files

[3D PDF](#)

[3D](#)

Customer View Model

[ENG_CVM_CVM_1-172163-9_L.2d_dxf.zip](#)

English

Customer View Model

[ENG_CVM_CVM_1-172163-9_L.3d_igs.zip](#)



English

Customer View Model

[ENG_CVM_CVM_1-172163-9_L.3d_stp.zip](#)

English

By downloading the CAD file I accept and agree to the [Terms and Conditions](#) of use.

Product Specifications

[Engineering Report](#)

English

Instruction Sheets

[Instruction Sheet \(U.S.\)](#)

English