



MQS

TE Internal #: 1-1355897-1

PCB Mount Header, Horizontal, Wire-to-Board, 4 Position, 2.54 mm [.1 in] Centerline, Fully Shrouded, Tin, Through Hole - Solder, Signal, Black, MQS

[View on TE.com >](#)

Connectors > PCB Connectors > PCB Headers & Receptacles > Signal Header

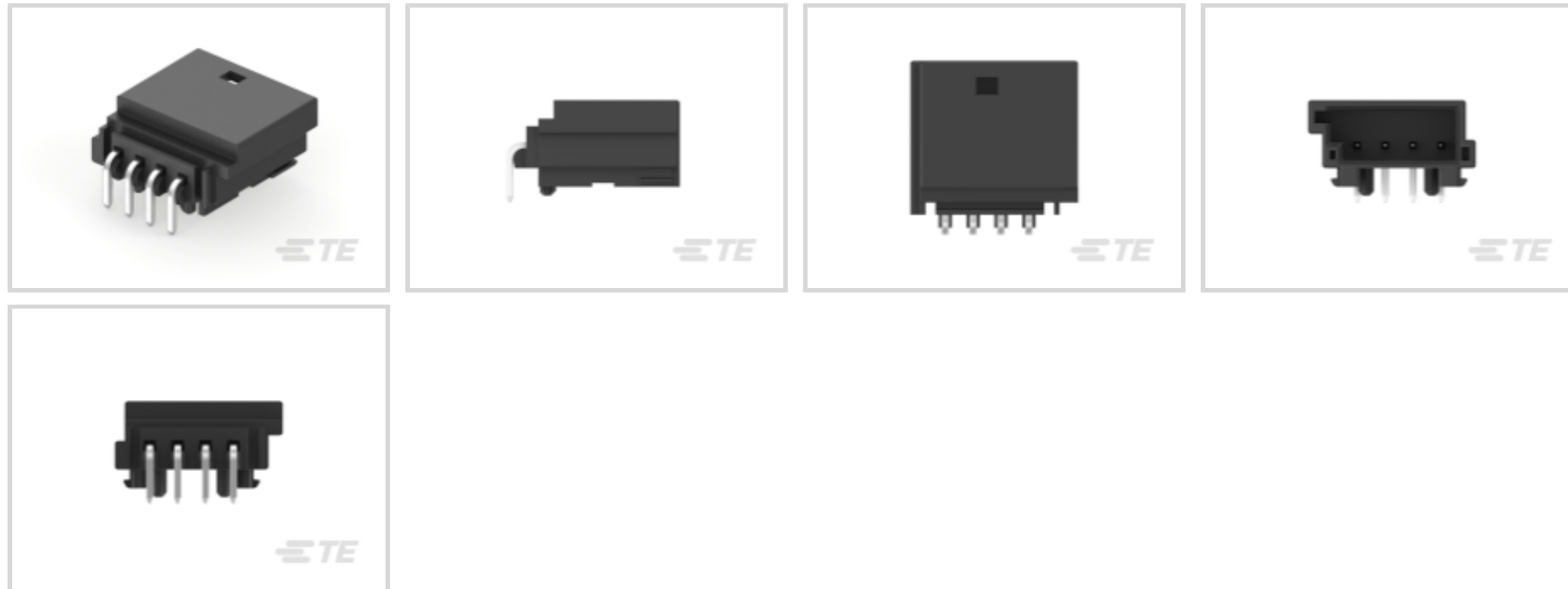

Connector System: **Wire-to-Board**
 Number of Positions: **4**
 Centerline (Pitch): **2.54 mm [.1 in]**
 Sealable: **No**
 PCB Mount Orientation: **Horizontal**

[All Signal Header \(320\)](#)

Features

Product Type Features

Mixed & Hybrid Header	No
Connector Shape	Rectangular
PCB Connector Assembly Type	PCB Mount Header
Header Type	Fully Shrouded
Connector System	Wire-to-Board
Sealable	No
Connector & Contact Terminates To	Printed Circuit Board

Configuration Features

Number of Sections	1
Number of Signal Positions	4
Number of Positions	4
PCB Mount Orientation	Horizontal
Number of Rows	1



Body Features

Primary Product Color	Black
Connector & Keying Code	A

Contact Features

Contact Size	.63mm
Contact Type	Tab
Mating Tab Width	.63 mm[.025 in]
Mating Tab Thickness	.63 mm[.025 in]
Contact Mating Area Plating Material	Tin

Termination Features

Termination Method to Printed Circuit Board	Through Hole - Solder
---	-----------------------

Mechanical Attachment

Mounting Holes	Without
Mating Retention	With
Mating Alignment	With
PCB Mount Alignment	With
Panel Mount Feature	Without
PCB Mount Retention	With
PCB Mount Retention Type	Boardlock
Mating Retention Type	Locking Interface

Housing Features

Centerline (Pitch)	2.54 mm[.1 in]
--------------------	----------------

Dimensions

Connector Length	15.3 mm[.6 in]
Connector Width	16 mm[.63 in]
PCB Thickness (Recommended)	.8 mm[.031 in]
Profile Height from PCB	7.9 mm[.311 in]

Operation/Application

Shielded	No
Circuit Application	Signal

Industry Standards



Degree of Protection	IP2B
----------------------	------

UL Flammability Rating	UL 94HB
------------------------	---------

Packaging Features

Packaging Quantity	250
--------------------	-----

Packaging Method	Loose Piece
------------------	-------------

Other

Interface Number	114-18063-18
------------------	--------------

Product Compliance

[For compliance documentation, visit the product page on TE.com>](#)

EU RoHS Directive 2011/65/EU	Compliant
------------------------------	-----------

EU ELV Directive 2000/53/EC	Compliant
-----------------------------	-----------

China RoHS 2 Directive MIIT Order No 32, 2016	No Restricted Materials Above Threshold
---	---

EU REACH Regulation (EC) No. 1907/2006	Current ECHA Candidate List: JUNE 2023 (235) Candidate List Declared Against: JUNE 2023 (235) Does not contain REACH SVHC
--	---

Halogen Content	Low Halogen - Br, Cl, F, I < 900 ppm per homogenous material. Also BFR/CFR/PVC Free
-----------------	---

Solder Process Capability	Not applicable for solder process capability
---------------------------	--

Product Compliance Disclaimer

This information is provided based on reasonable inquiry of our suppliers and represents our current actual knowledge based on the information they provided. This information is subject to change. The part numbers that TE has identified as EU RoHS compliant have a maximum concentration of 0.1% by weight in homogenous materials for lead, hexavalent chromium, mercury, PBB, PBDE, DBP, BBP, DEHP, DIBP, and 0.01% for cadmium, or qualify for an exemption to these limits as defined in the Annexes of Directive 2011/65/EU (RoHS2). Finished electrical and electronic equipment products will be CE marked as required by Directive 2011/65/EU. Components may not be CE marked. Additionally, the part numbers that TE has identified as EU ELV compliant have a maximum concentration of 0.1% by weight in homogenous materials for lead, hexavalent chromium, and mercury, and 0.01% for cadmium, or qualify for an exemption to these limits as defined in the Annexes of Directive 2000/53/EC (ELV). Regarding the REACH Regulation, the information TE provides on SVHC in articles for this part number is based on the latest European Chemicals Agency (ECHA) 'Guidance on requirements for substances in articles' posted at this URL: <https://echa.europa.eu/guidance-documents/guidance-on-reach>

Compatible Parts



Also in the Series | **MQS**

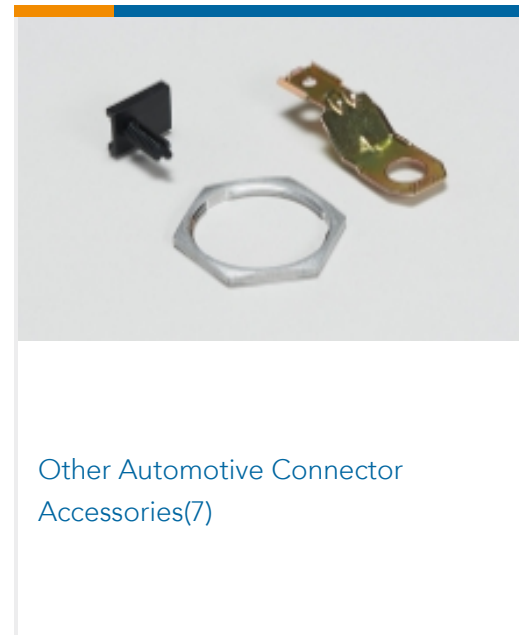
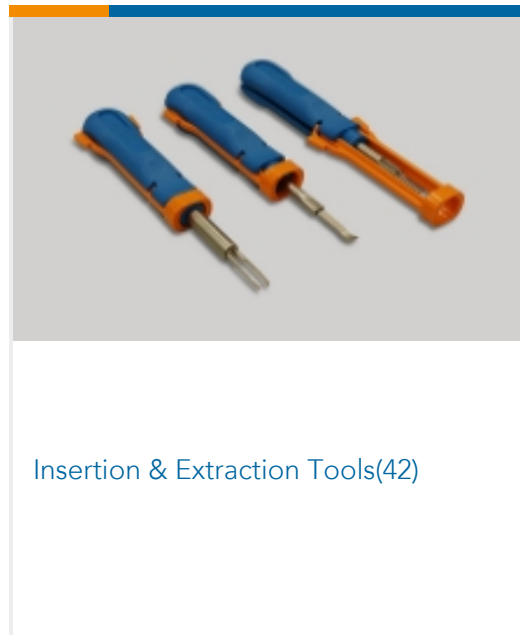
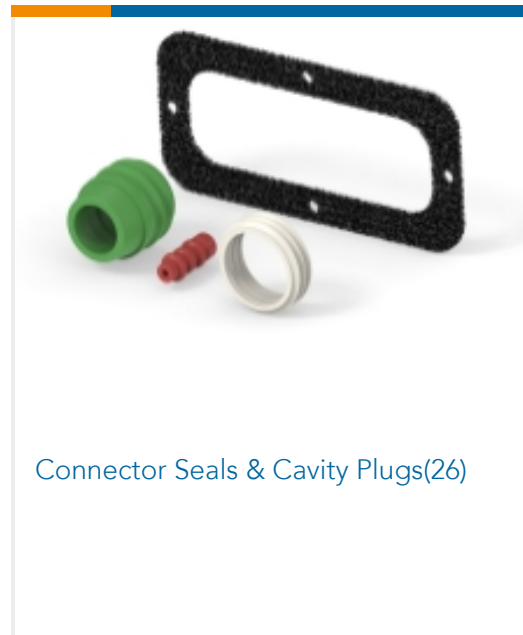
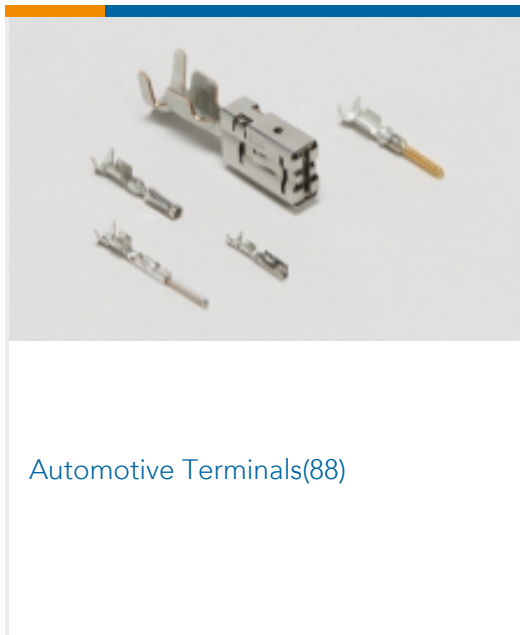
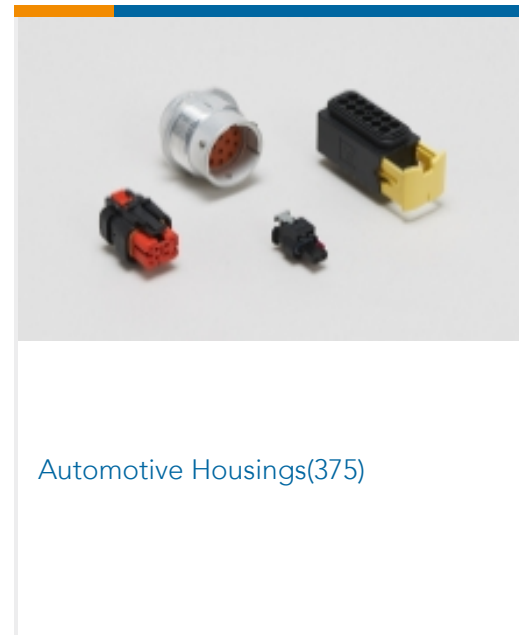

Customers Also Bought

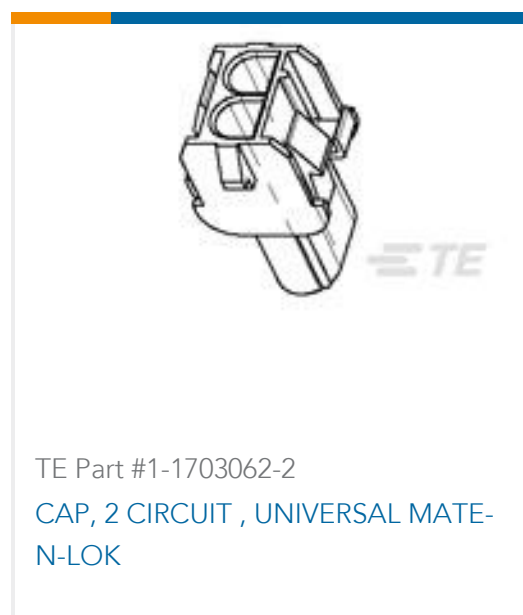



Documents

Product Drawings

4pos MQS .63 header 90deg

English

CAD Files

Customer View Model

ENG_CVM_CVM_1-1355897-1_A.2d_dxf.zip

English

3D PDF

3D

Customer View Model

ENG_CVM_CVM_1-1355897-1_A.3d_igs.zip

English

Customer View Model

ENG_CVM_CVM_1-1355897-1_A.3d_stp.zip

English

By downloading the CAD file I accept and agree to the [Terms and Conditions](#) of use.

Product Specifications

Product Specification

English