

0RQ1-T0S12B

Isolated DC-DC Converter

The 0RQ1-T0S12B is an isolated DC/DC converter that operates from a nominal 48 VDC source. This unit provides up to 300 W of output power from a nominal 48 VDC input. This unit is designed to be highly efficient and low cost. Features include remote on/off, short circuit protection, over current protection, under voltage lockout and over-temperature protection. The converter is provided in an industry standard quarter brick package.

Key Features & Benefits

- 36 – 62 VDC Input
- 12 VDC / 25 A Output
- Basic Isolation
- Input Under-Voltage Lockout
- High Efficiency
- Input Over Voltage Lockout
- Fixed Frequency (220 kHz)
- Output Over-Voltage Protection
- High Power Density
- OCP / SCP
- Low Cost
- Over Temperature Protection
- Remote ON/OFF
- Approved to IEC/EN 62368-1
- Approved to UL/CSA 62368-1
- Class II, Category 2, Isolated DC/DC Converter (refer to IPC-9592B)



Applications

- Networking
- Computers and Peripherals
- Telecommunications

1. MODEL SELECTION

MODEL NUMBER	OUTPUT VOLTAGE	INPUT VOLTAGE	MAX. OUTPUT CURRENT	MAX. OUTPUT POWER	TYPICAL EFFICIENCY
ORQ1-T0S12BG	12 VDC	36 - 62 VDC	25 A	300 W	96%

PART NUMBER EXPLANATION

0	R	Q1	-	T0	S	12	B	G
Mounting Type	RoHS	Series Name		Output Power	Input Range	Output Voltage	Active Logic	Package
Through Hole Mount	RoHS	1/4 th Brick		300 W	36 - 60 V	12 V	Active Low with Baseplate	Tray Package

2. ABSOLUTE MAXIMUM RATINGS

PARAMETER	DESCRIPTION	MIN	TYP	MAX	UNITS
Input Voltage	Continuous, non-operating	-0.3	-	80	V
Input Voltage Transient Protection	Operating for 100 ms	-	-	70	V
Remote On/Off		-0.3	-	18	V
I/O Isolation Voltage		-	-	2250	V
Ambient Temperature		-40	-	85	°C
Storage Temperature		-55	-	125	°C
Altitude		-	-	5000	m

NOTE: Ratings used beyond the maximum ratings may cause a reliability degradation of the converter or may permanently damage the device.

3. INPUT SPECIFICATIONS

PARAMETER	DESCRIPTION	MIN	TYP	MAX	UNIT
Operating Input Voltage		36	48	62	V
Input Current (full load)		-	-	9	A
Input Current (no load)		-	70	150	mA
Remote Off Input Current		-	15	20	mA
Input Reflected Ripple Current (rms)	10 μ H source impedance; $V_{in} = 48$ V, $I_o = I_o$ max	-	50	-	mA
Input Reflected Ripple Current (pk-pk)		-	160	-	mA
I^2t Inrush Current Transient		-	-	1	A ² s
Turn-on Voltage Threshold		-	34.5	36	V
Turn-off Voltage Threshold		32	34	-	V

CAUTION: This converter is not internally fused. An input line fuse must be used in application.

Recommend a fast-acting fuse with maximum rating of 5 A on system board. Refer to the fuse manufacture's datasheet for further information.

NOTE: All specifications are typical at 25°C unless otherwise stated.

4. OUTPUT SPECIFICATIONS

PARAMETER	DESCRIPTION	MIN	TYP	MAX	UNIT
Output Voltage Set Point	Vin = 48 V, Io = 50% load	11.76	12.00	12.24	V
Load Regulation	Io = 0~100% load	-	20	40	mV
Line Regulation	Vin = 36 ~ 62 V	-	20	60	mV
Regulation Over Temperature		-	50	100	mV
Ripple and Noise (pk-pk)	Vin = 48 V, Io = 100% load at 25°C ambient, 0 - 20 MHz BW, with a 1 µF ceramic capacitor and a 270 µF AL. cap at output.	-	60	120	mV
Ripple and Noise (rms)		-	20	40	mV
Ripple and Noise (pk-pk) under worst case	Over entire operating input voltage range, load and ambient temperature condition.	-	-	200	mV
Output Current Range		0	-	25	A
Output DC Current Limit		28	30	34	A
Short Circuit Surge Transient		-	-	6	A ² s
Rise Time		-	25	-	ms
Turn on Delay Time	Enable from Vin	-	40	45	ms
	Enable from ON/OFF	-	40	45	ms
Overshoot at Turn on		-	0	3	%
Output Capacitance		270	-	10000	µF
Transient Response					
ΔV 50%~75% of Max Load	di/dt = 0.1 A/µs, Vin = 48 VDC, Ta = 25°C, with a 1 µF ceramic capacitor and a 270 µF AL. cap at output.	-	300	-	mV
Settling Time	Vo = 12 V	-	500	-	µs
ΔV 75%~50% of Max Load		-	300	-	mV
Settling Time		-	500	-	µs

NOTE: All specifications are typical at nominal input, full load at 25°C unless otherwise stated.

5. GENERAL SPECIFICATIONS

PARAMETER	DESCRIPTION	MIN	TYP	MAX	UNIT
Efficiency	Vin = 48 V, full load	95	96	-	%
Switching Frequency		-	220	-	kHz
Over Temperature Protection		-	125	-	°C
Over Voltage Protection		-	-	14	V
FIT	Calculated Per Bell Core SR-332 (Vin = 48 V, Vo = 12 V, Io = 20 A, Ta = 25°C, FIT = 10 ⁹ /MTBF)		72.34		-
Weight		-	68	-	g
Dimensions (L x W x H)			2.30 x 1.45 x 0.55		inch
			58.42x 36.83 x 14.00		mm
Isolation Characteristics					
Input to Output		-	-	2250	V
Isolation Resistance		10M	-	-	Ohm
Isolation Capacitance		-	3300	-	pF



Asia-Pacific
+86 755 298 85888

Europe, Middle East
+353 61 225 977

North America
+1 408 785 5200

6. EFFICIENCY DATA

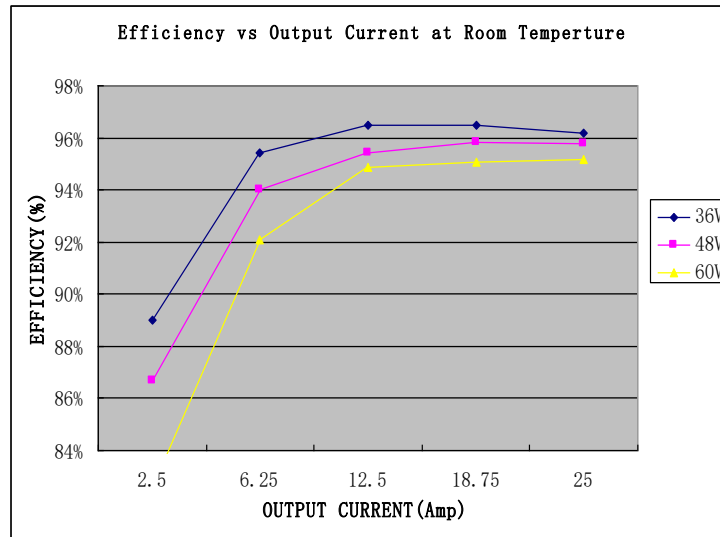

Figure 1. Efficiency data

7. REMOTE ON/OFF

PARAMETER	DESCRIPTION	MIN	TYP	MAX	UNIT
Signal Low (Unit On)	Active Low Remote On/Off pin is open, the module is off.	-0.3	-	0.8	V
Signal High (Unit Off)		2.4	-	18	V
Current Sink		0	-	1	mA

Recommended remote on/off circuit for active low

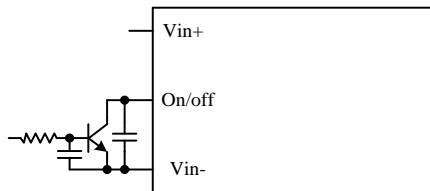

Figure 2. Control with open collector/drain circuit

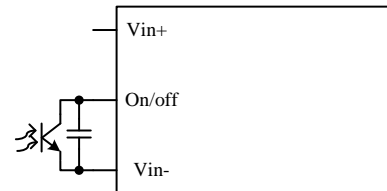

Figure 3. Control with photocoupler circuit

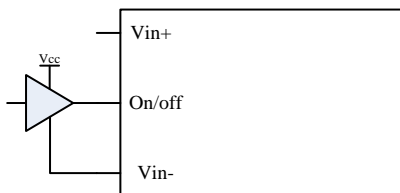

Figure 4. Control with logic circuit

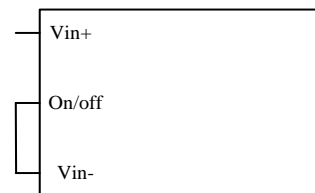

Figure 5. Permanently on

8. RIPPLE AND NOISE WAVEFORM

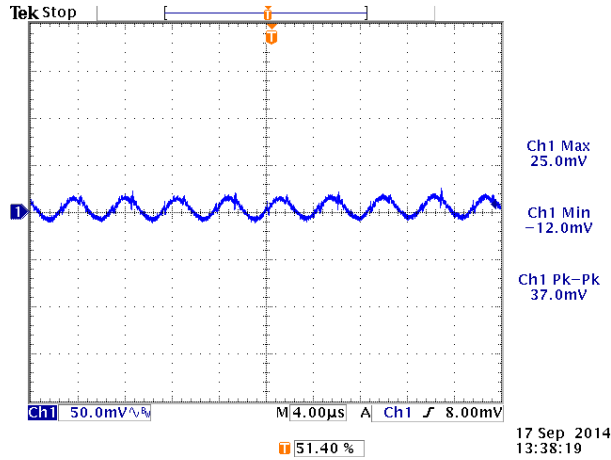

Figure 6.

NOTE: Ripple and noise at full load, 48 VDC input, 12 VDC / 25 A output and $T_a = 25\text{ }^\circ\text{C}$, and with a $1\text{ }\mu\text{F}$ ceramic cap and a $270\text{ }\mu\text{F}$ AL. cap at output.

9. TRANSIENT RESPONSE WAVEFORMS

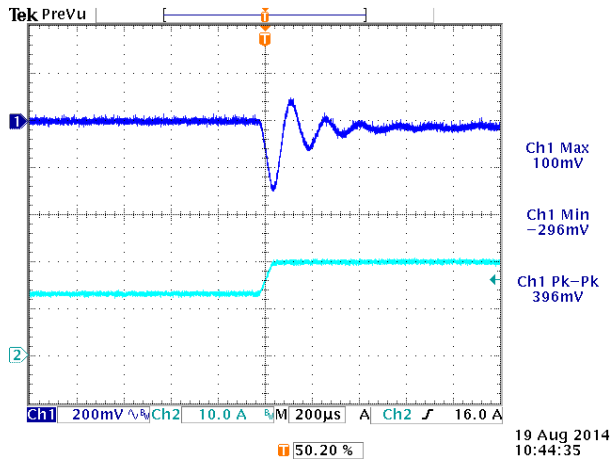

Figure 7. $V_{out} = 12\text{ V}$, 50%-75% Load Transients

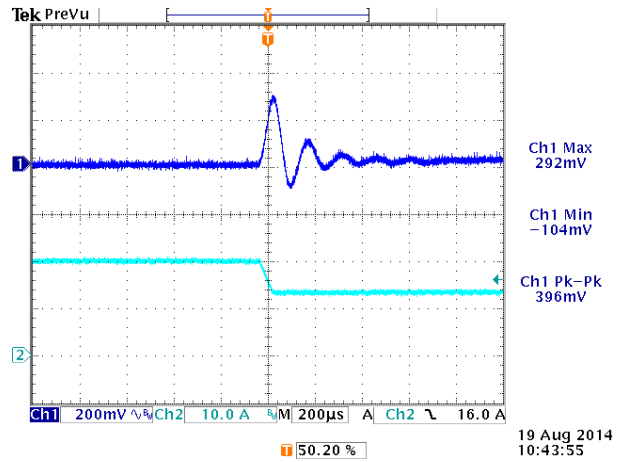

Figure 8. $V_{out} = 12\text{ V}$, 75%-50% Load Transients

NOTE: Transient Response at $V_{in} = 48\text{ V}$, $di/dt = 0.1\text{ A} / \mu\text{s}$, $1\text{ }\mu\text{F}$ ceramic cap and $270\text{ }\mu\text{F}$ AL. cap at output, $T_a = 25\text{ }^\circ\text{C}$.

10. STARTUP & SHUTDOWN

Turn on rise time

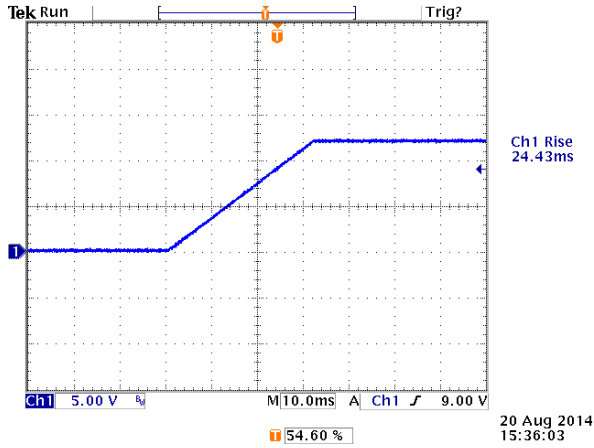

Figure 9. $V_{in} = 48\text{ V}$ @ $T_a = 25^\circ\text{C}$, $V_o = 12\text{ V}$,
 $I_o = 25\text{ A}$, $C_{ext} = 0\ \mu\text{F}$

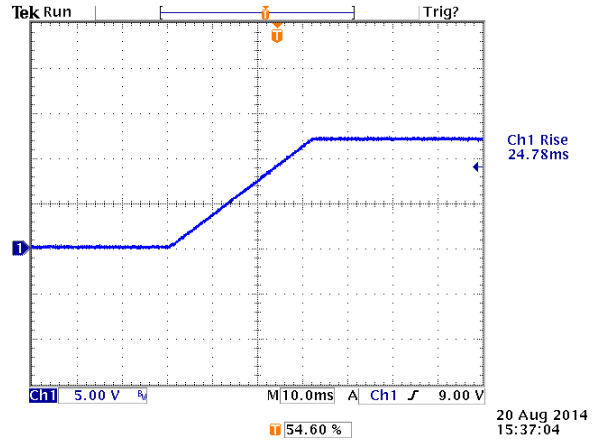

Figure 10. $V_{in} = 48\text{ V}$ @ $T_a = 25^\circ\text{C}$, $V_o = 12\text{ V}$,
 $I_o = 25\text{ A}$, $C_{ext} = 10000\ \mu\text{F}$

Turn on startup time

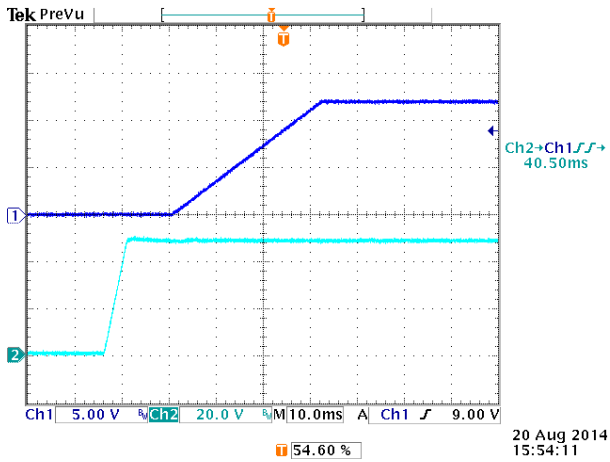

Figure 11. Startup from V_{in}
Ch1: V_o
Ch2: V_{in}
 $V_{in} = 48\text{ V}$ @ $T_a = 25^\circ\text{C}$, $V_o = 12\text{ V}$,
 $I_o = 25\text{ A}$, $C_{ext} = 10000\ \mu\text{F}$

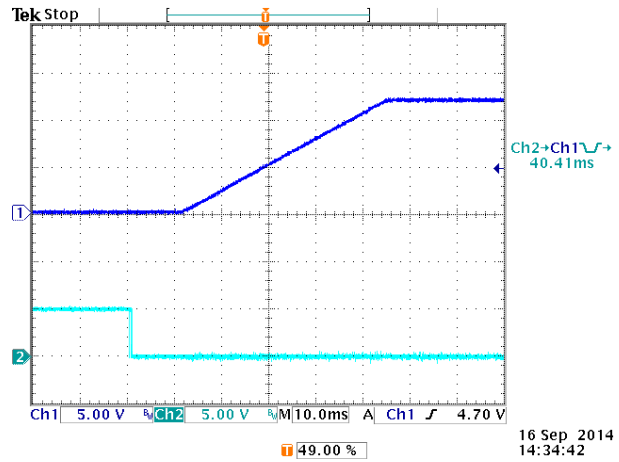

Figure 12. Startup from ON/OFF
Ch1: V_o
Ch2: ON/OFF
 $V_{in} = 48\text{ V}$ @ $T_a = 25^\circ\text{C}$, $V_o = 12\text{ V}$,
 $I_o = 25\text{ A}$, $C_{ext} = 10000\ \mu\text{F}$

Shutdown

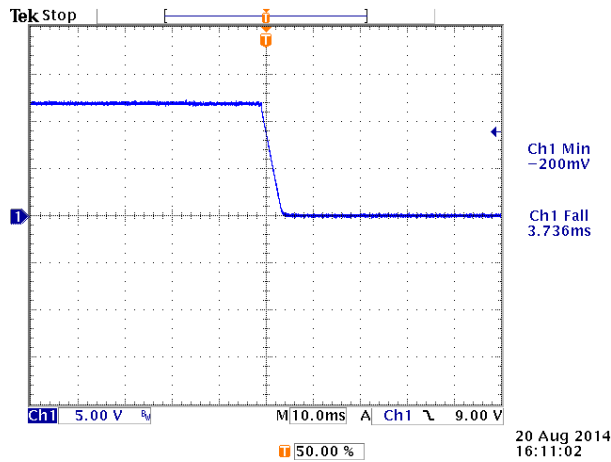

Figure 13. $V_{in} = 48\text{ V}$ @ $T_a = 25^\circ\text{C}$, $V_o = 12\text{ V}$, $I_o = 25\text{ A}$, $C_{ext} = 10000\ \mu\text{F}$

11. OVER CURRENT PROTECTION

To provide protection in a fault output overload condition, the module is equipped with internal current-limiting circuitry which can endure current limiting for a few milliseconds. If the over current condition persists beyond a few milliseconds, the module will shut down into hiccup mode and restart once every 400 ms. The module operates normally when the output current goes into specified range. The typical average output current is 1.77 A during hiccup.

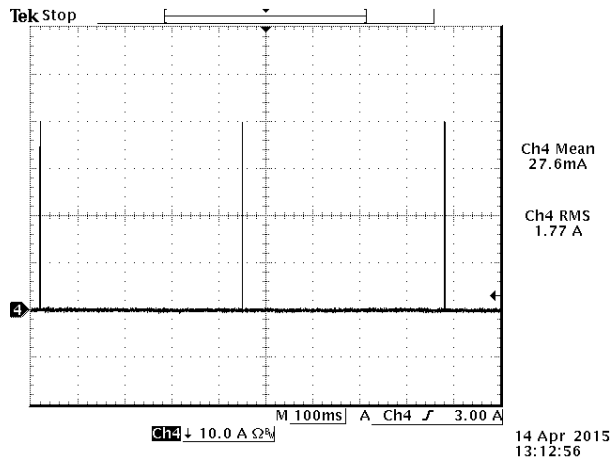

Figure 14. Over current protection

12. INPUT UNDER-VOLTAGE LOCKOUT

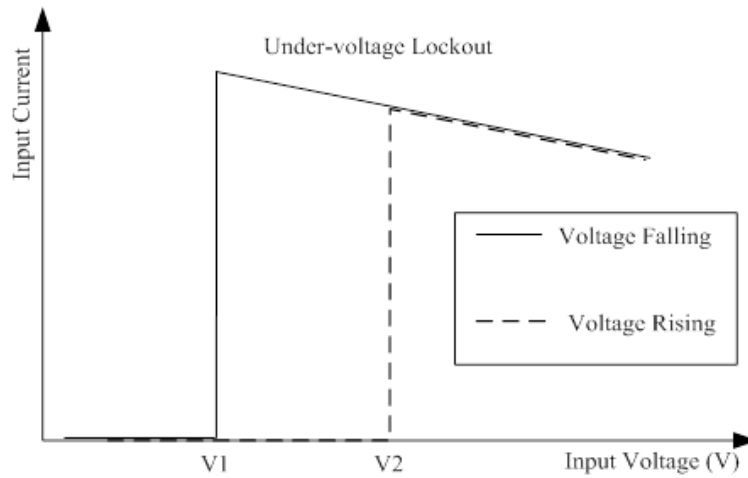

Figure 15. Input under-voltage lockout

$V1 = 33\text{ V}$

$V2 = 34\text{ V}$

13. THERMAL DERATING CURVE

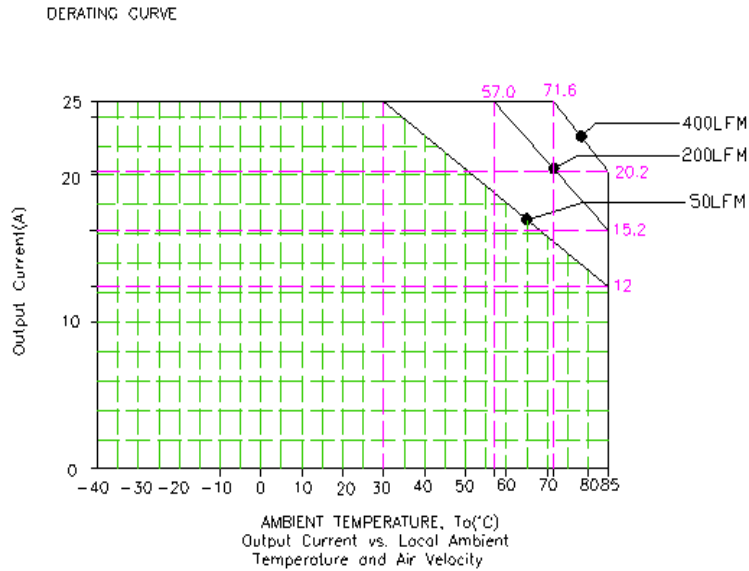

Figure 16. Derating curve
Maximum junction temperature of semiconductors derated to 120°C.

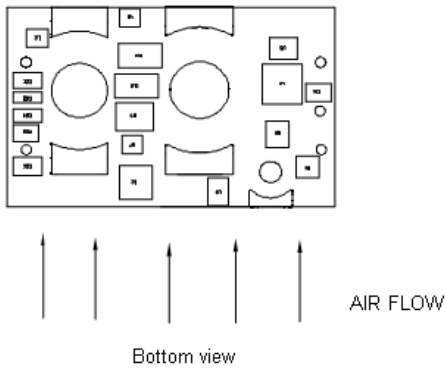

Figure 17. Airflow direction

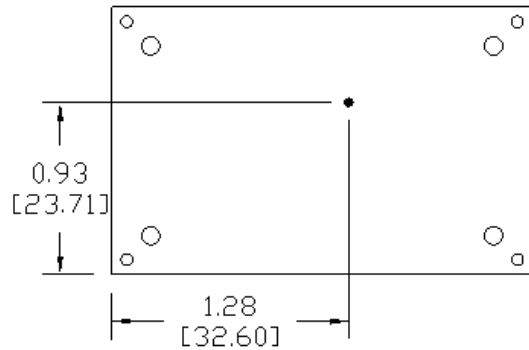

Figure 18. Temperature reference points on baseplate

The OTP is achieved by temperature sensor and it is in non-latch mode when the hottest point on base plate reaches 105°C. It will restart automatically when the temperature falls to 90°C. The protecting point will be varied a little under different conditions (airflow, ambient temperature, input voltage, load...)

14. SAFETY & EMC

SAFETY:

1. Material flammability UL94V-0
2. Approved to IEC/EN 62368-1
3. Approved to UL/CSA 62368-1

EMC:

1. Conductive EMI: EN55032 class A

Compliance to EN55032 class A (both peak and average) with the following inductive and capacitive filter

Test setup:

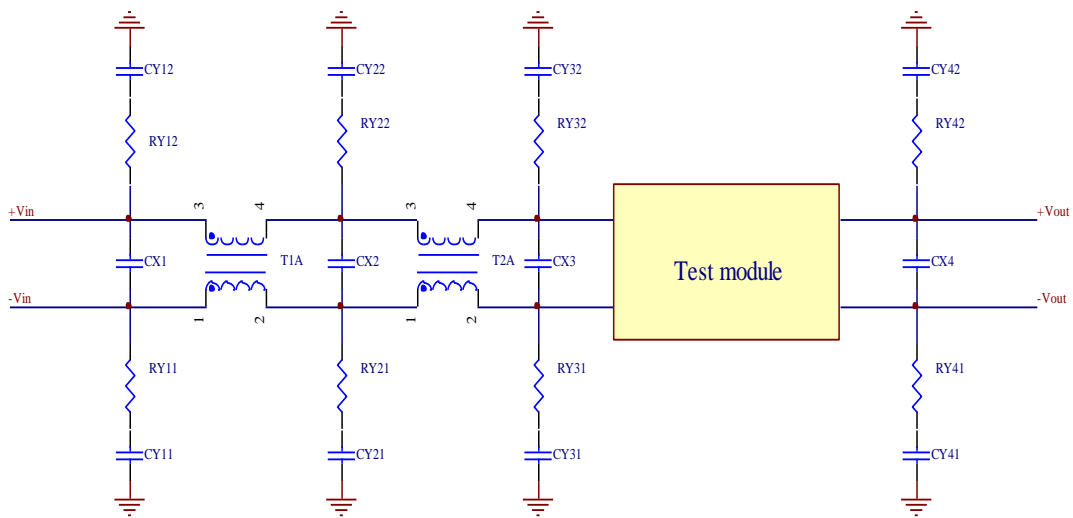

Figure 19.

ITEM	DESIGNATOR	PARAMETER	VENDOR	VENDOR P/N
1	CX2	100µF/100V, AL cap		
2	CX3	100µF/100V, AL cap		
3	CY31	2*6.8nF/1000V,ceramic		
4	CY32	2*6.8nF/1000V,ceramic		
5	CY41	6.8nF/1000V,ceramic		
6	CY42	6.8nF/1000V,ceramic		
7	RY31	1206,0R,Resistor		
8	RY32	1206,0R,Resistor		
9	RY41	1206,0R,Resistor		
10	RY42	1206,0R,Resistor		
11	T2A	1mH, common mode		
12	T1A, CX1, CX2, RY11, RY21, RY12, RY22, CY11, CY21, CY12, CY22	NIL		

Positive:

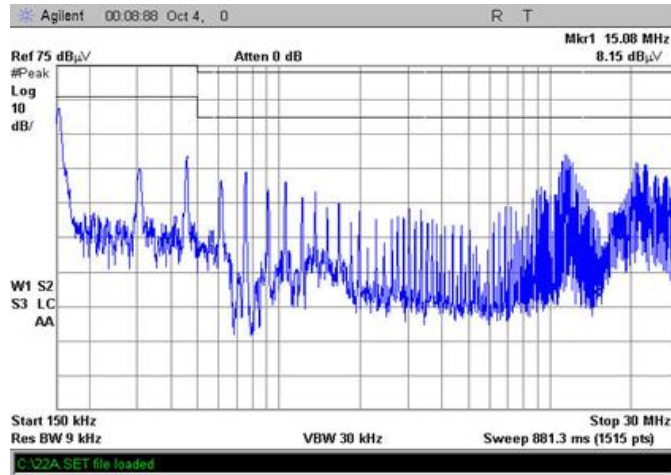

Figure 20.

Negative:

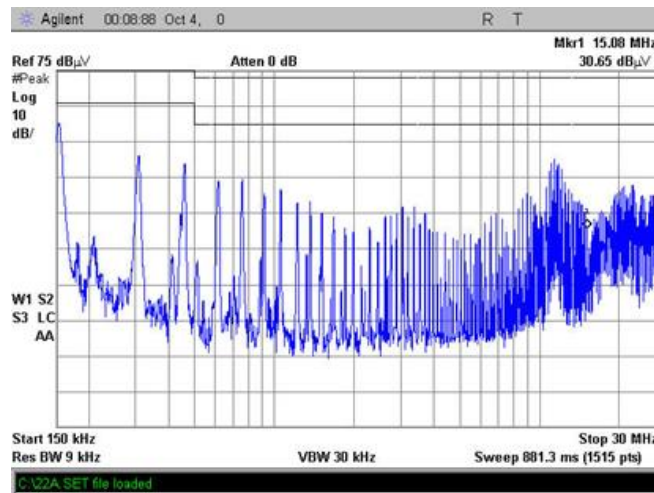

Figure 21.

15. MECHANICAL DIMENSIONS

OUTLINE

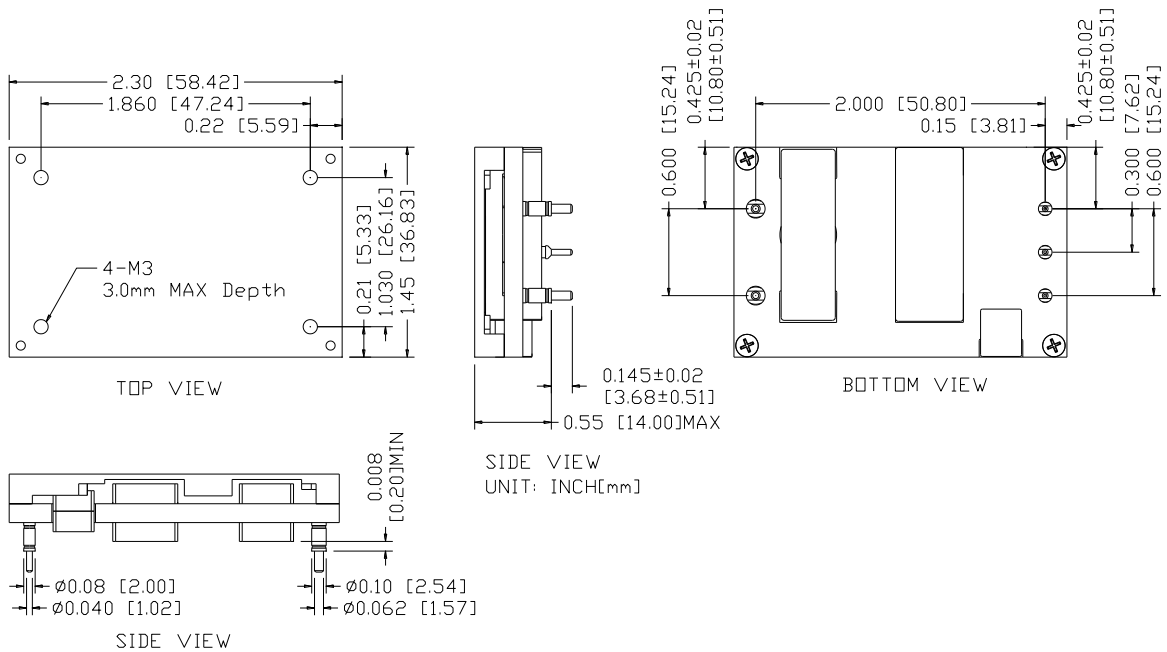

Figure 22. Outline

NOTE: This module is recommended and compatible with Pb-Free Wave Soldering and must be soldered using a peak solder temperature of no more than 260 °C for less than 5 seconds.

NOTE:

1) All Pins: Material - Copper Alloy;

Finish – 3 micro inches minimum Gold over 50 micro inches minimum Nickel plate.

2) Un-dimensioned components are shown for visual reference only.

3) All dimensions in inch [mm]; Tolerances: x.xx +/-0.02 inch [0.5mm].

x.xxx +/-0.010 inch [0.25mm]. Unless otherwise stated.

16. REVISION HISTORY

DATE	REVISION	CHANGES DETAIL	APPROVAL
2015-1-27	A	First release	S.Wang
2015-8-14	B	<ol style="list-style-type: none"> 1. Update Fixed Frequency from 300kHz to 220kHz 2. Update Line Regulation Max value from 40mv to 60mv 3. Update Output Ripple and Noise (rms) from 20mv to 30mv 4. Update Ripple and Noise (pk-pk) under worst case from 150mv to 200mv 	S.Wang
2015-9-17	C	<ol style="list-style-type: none"> 1. Add FIT data. 2. Update mechanical drawing, change width from 2.28" to 2.3". 3. Update Isolation Capacitance from 2700pF to 3300pF. 4. Delete TUV Certification in Safety. 	S.Wang
2015-12-10	D	<ol style="list-style-type: none"> 1. Update Safety and EMC 	S.Wang
2018-05-15	AE	Update Part Number Explanation	S.Wang
2019-06-20	AF	Update Ripple and Noise (pk-pk) and Ripple and Noise (rms); Add Safety Certification	S.Wang
2021-05-11	AG	Add object ID and over current protection waveform. Update altitude and mechanical drawing.	XF.Jiang

For more information on these products consult: tech.support@psbel.com

NUCLEAR AND MEDICAL APPLICATIONS - Products are not designed or intended for use as critical components in life support systems, equipment used in hazardous environments, or nuclear control systems.

TECHNICAL REVISIONS - The appearance of products, including safety agency certifications pictured on labels, may change depending on the date manufactured. Specifications are subject to change without notice.



tech.support@psbel.com
belfuse.com/power-solutions