

Product description	<b>M16 IP40 female panel mount connector, Contacts: 14, shielding is not possible, solder, IP40</b>
Area	<b>M16 IP40 series 680</b>
Order number	<b>09 0054 80 14</b>

**Illustration**

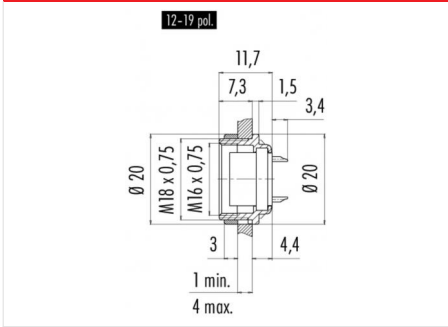

**Scale drawing**



**Contact arrangement**

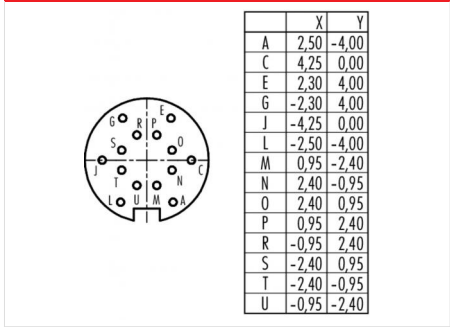

You can find the assembly instructions on the next page.

**Technical data**

**General values**

Connector design	female panel mount connector
Connector locking system	screw
Termination	solder
Wire gauge (mm)	0.25 mm <sup>2</sup>
Wire gauge (AWG)	24
Upper limit temperature	85 °C
Lower limit temperature	- 40 °C
Customs tariff number	85369010
Packaging Unit	20

**Electrical values**

Rated current (40 °C)	3 A
Rated voltage	60 V
Rated impulse voltage	500 V
Pollution degree	1
Overvoltage category	I
Insulating material group	III
Insulation resistance	≥ 10 <sup>10</sup> Ω
EMC compliance	shielding is not possible
Degree of protection	IP40
Mechanical operation	> 500 Mating cycles

**Material**

Contact material	CuSn (bronze)
Contact plating	Au (gold)
Contact body material	PBT (UL94 V-0)
Housing material	Zinc die-cast nickel-plated

Product description **M16 IP40 female panel mount connector, Contacts: 14, shielding is not possible, solder, IP40**

Area **M16 IP40 series 680**  
Order number **09 0054 80 14**

Assembly instructions / Panel cut-out

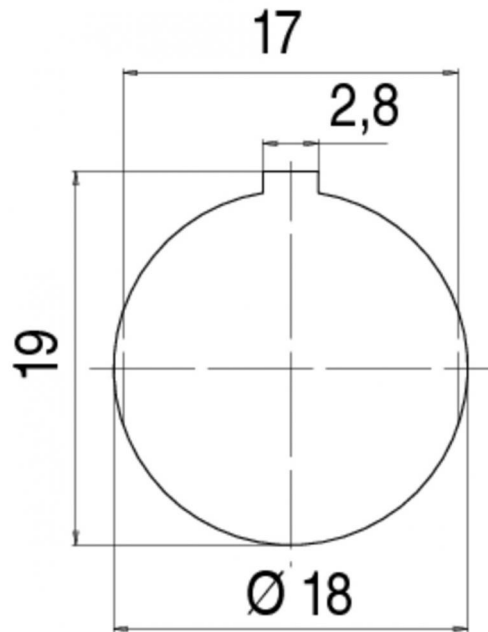

Product description	<b>M16 IP40 female panel mount connector, Contacts: 14, shielding is not possible, solder, IP40</b>
Area	<b>M16 IP40 series 680</b>
Order number	<b>09 0054 80 14</b>

## Security notices

The connectors are designed for use in plant, control system and electrical equipment. The end user is responsible for checking whether the connectors are suitable for use in other applications.