

Heavy Duty Fuse Clip, 10.3 x 38 /10.3 x 85 mm, 1500 VAC/VDC, 32 A



Solder THT version



Screw or rivet version

1500 V · 32 A

Approvals and Compliances

Description

- Solder, screw or rivet mounting
- For photovoltaic and other DC applications
- Suitable gPV fuse link ASO 10.3x38

Unique Selling Proposition

- Unique 1500 VDC/VAC and 32 A
- Minimal power loss due to strong clamping force

Applications

- All photovoltaic applications
- Inverters
- Battery charge controllers
- String fuse holder
- DC applications

References

Fuseholder to [ASO 10.3x38](#)

Weblinks

[pdf datasheet](#), [html-datasheet](#), [General Product Information](#), [Packaging details](#), [Distributor-Stock-Check](#), [Accessories](#), [Detailed request for product](#), [Microsite](#)

Technical Data

Fuse-Link	10.3 x 38 / 10.3 x 85 mm
Mounting	PCB
Terminal	Solder THT, screw or rivet
Rated Voltage	1500V
Rated current	32A
Admissible Ambient Air Temp.	-40°C to 155°C ¹⁾
Climatic Category	40/155/21 acc. to IEC 60068-1 ¹⁾
Material	Copper alloy, silver-plated / tin-plated ¹⁾
Storage Conditions	0°C to 60°C, max. 70% r.h.
Product Marking	 Ttype

Soldering Methods	Wave Soldering Profile
Solderability	245 °C / 3 sec acc. to IEC 60068-2-20, Test Ta, method 1
Resistance to Soldering Heat	260 °C / 10 sec acc. to IEC 60068-2-20, Test Tb, method 1
Contact Resistance	≤ 1 mΩ at 20 mV

¹⁾ Details see table of variants

Approvals and Compliances

Detailed information on product approvals, code requirements, usage instructions and detailed test conditions can be looked up in [Details about Approvals](#)

Approvals

The approval mark is used by the testing authorities to certify compliance with the safety requirements placed on electronic products.

Approval Reference Type: CSO

Approval Logo	Certificates	Certification Body	Description
	UL Approvals	UL	UL File Number: E39328

Product standards

Product standards that are referenced

Organization	Design	Standard	Description
	Designed according to	UL 4248-1	Fuseholder general requirements
	Designed according to	CSA C22.2 no. 4248.1	Fuseholder general requirements





Application standards

Application standards where the product can be used

Organization	Design	Standard	Description
	Designed for applications acc.	IEC/UL 60950	IEC 60950-1 includes the basic requirements for the safety of information technology equipment.

Compliances

The product complies with following Guide Lines

Identification	Details	Initiator	Description
	CE declaration of conformity	SCHURTER AG	The CE marking declares that the product complies with the applicable requirements laid down in the harmonisation of Community legislation on its affixing in accordance with EU Regulation 765/2008.
	RoHS	SCHURTER AG	EU Directive RoHS 2011/65/EU
	China RoHS	SCHURTER AG	The law SJ / T 11363-2006 (China RoHS) has been in force since 1 March 2007. It is similar to the EU directive RoHS.
	REACH	SCHURTER AG	On 1 June 2007, Regulation (EC) No 1907/2006 on the Registration, Evaluation, Authorization and Restriction of Chemicals 1 (abbreviated as "REACH") entered into force.

Dimension [mm]

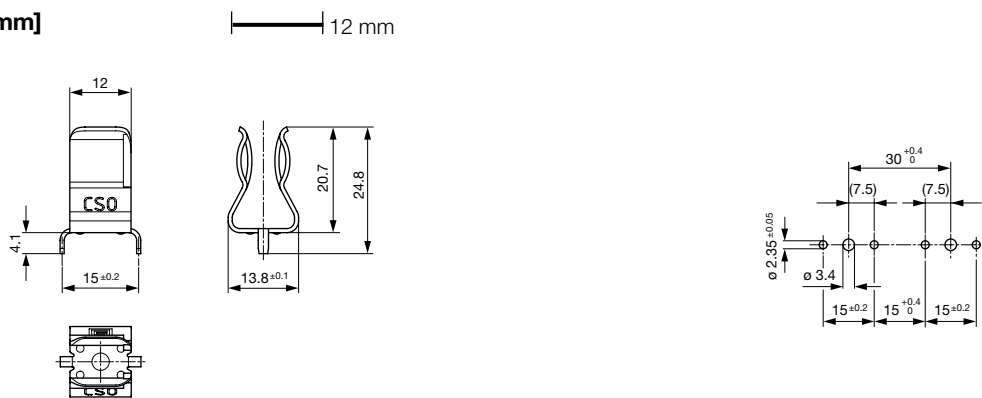

Solder THT version

Drilling diagram



Screw or rivet version

Drilling diagram

All Variants

Weight	Terminal	Packaging	Admissible Ambient Air Temp.	Climatic Category	Coating	Order Number
4.45 g	Screw or Rivet	Bulk 128 x 91 x 60 mm (100 pcs.)	-40 °C - 155 °C	40/155/21	silver-plated	0751.0500
4.45 g	Screw or Rivet	Bulk 251 x 159 x 152 mm (1000 pcs.)	-40 °C - 155 °C	40/155/21	silver-plated	0751.0501
4.45 g	Screw or Rivet	Bulk 128 x 91 x 60 mm (100 pcs.)	-40 °C - 125 °C	40/125/21	tinned	0751.0502
4.45 g	Screw or Rivet	Bulk 251 x 159 x 152 mm (1000 pcs.)	-40 °C - 125 °C	40/125/21	tinned	0751.0503
4.6 g	Solder, THT	Bulk 128 x 91 x 60 mm (100 pcs.)	-40 °C - 155 °C	40/155/21	silver-plated	0751.0505
4.6 g	Solder, THT	Bulk 251 x 159 x 152 mm (1000 pcs.)	-40 °C - 155 °C	40/155/21	silver-plated	0751.0506
4.6 g	Solder, THT	Bulk 128 x 91 x 60 mm (100 pcs.)	-40 °C - 125 °C	40/125/21	tinned	0751.0507
4.6 g	Solder, THT	Bulk 251 x 159 x 152 mm (1000 pcs.)	-40 °C - 125 °C	40/125/21	tinned	0751.0508

 Most Popular.

Weight	Terminal	Packaging	Admissible Ambient Air Temp.	Climatic Category	Coating	Order Number
--------	----------	-----------	------------------------------	-------------------	---------	--------------

Availability for all products can be searched real-time:<https://www.schurter.com/en/Stock-Check/Stock-Check-SCHURTER>

Accessories

Description



ESO 10.3x38
Fuse Inserter/Extractor with Cover Function for 10.3x38 mm Fuses in Clips, Patent Pending