

TOP1.5GS8/90 7 2STI OR

Weidmüller Interfaces GmbH & Co. KG

Postfach 3030

32760 Detmold

Tel. +49 5231 14-0

Fax. +49 5231 14-2083

info@weidmueller.com

www.weidmueller.com

Product image



Similar to illustration

Conductor entry and screw connection in the same direction on this PCB terminal with 7.62 mm pitch for conductor cross-sections up to 2.5 mm². Conductor outlet direction 90° and 180°.

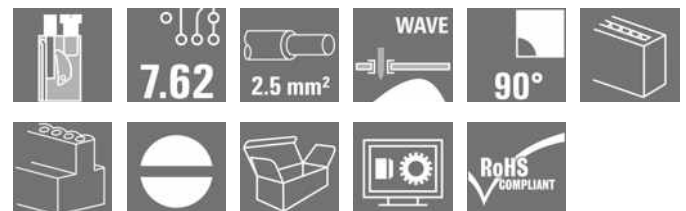

General ordering data

| | |
|-----------------|---|
| Version | Printed circuit board terminals, 7.62 mm, Number of poles: 8, 90°, Solder pin length (l): 3.5 mm, tinned, orange, TOP connection, Clamping range, max.: 2.5 mm ² , Box |
| Order No. | 0642460000 |
| Type | TOP1.5GS8/90 7 2STI OR |
| GTIN (EAN) | 4008190134242 |
| Qty. | 20 pc(s). |
| Product data | IEC: 1000 V / 24 A / 0.5 - 2.5 mm ² UL: 300 V / 10 A / AWG 26 - AWG 14 |
| Packaging | Box |
| Delivery status | This article will no longer be available in the future. |
| Available until | 2023-03-31 |

TOP1.5GS8/90 7 2STI OR

Weidmüller Interfaces GmbH & Co. KG

Postfach 3030

32760 Detmold

Tel. +49 5231 14-0

Fax. +49 5231 14-2083

info@weidmueller.com

www.weidmueller.com

Technical data

Dimensions and weights

| | | | |
|--------------------------|------------|-----------------|------------|
| Depth | 19.5 mm | Depth (inches) | 0.768 inch |
| Height | 22 mm | Height (inches) | 0.866 inch |
| Height of lowest version | 18.5 mm | Width | 62.76 mm |
| Width (inches) | 2.471 inch | Net weight | 32.5 g |

Temperatures

| | | | |
|-----------------------------|--------|-----------------------------|--------|
| Operating temperature, min. | -50 °C | Operating temperature, max. | 100 °C |
|-----------------------------|--------|-----------------------------|--------|

System parameters

| | | | |
|--|-----------------------------------|--|----------------|
| Product family | OMNIMATE Signal - series TOP1.5GS | Wire connection method | TOP connection |
| Mounting onto the PCB | THT solder connection | Conductor outlet direction | 90° |
| Pitch in mm (P) | 7.62 mm | Pitch in inches (P) | 0.3 inch |
| Number of poles | 8 | Pin series quantity | 1 |
| Fitted by customer | No | Number of rows | 1 |
| Solder pin length (l) | 3.5 mm | Solder pin dimensions | 0.8 x 1.0 mm |
| Solder eyelet hole diameter (D) | 1.3 mm | Solder eyelet hole diameter tolerance (D) | + 0,1 mm |
| Number of solder pins per pole | 2 | Screwdriver blade | 0.6 x 3.5 |
| Screwdriver blade standard | DIN 5264 | Tightening torque, min. | 0.4 Nm |
| Tightening torque, max. | 0.5 Nm | Clamping screw | M 2.5 |
| Stripping length | 10 mm | L1 in mm | 53.34 mm |
| L1 in inches | 2.1 inch | Touch-safe protection acc. to DIN VDE 0470 | IP 20 |
| Touch-safe protection acc. to DIN VDE 57 106 | Safe from finger touch | Protection degree | IP20 |
| Volume resistance | 1.20 mΩ | | |

Material data

| | | | |
|---------------------------------------|----------|---------------------------------------|-----------------------------|
| Insulating material | PA | Colour | orange |
| Colour chart (similar) | RAL 2000 | Insulating material group | I |
| Comparative Tracking Index (CTI) | ≥ 600 | Insulation strength | ≥ 10 ⁸ Ω |
| UL 94 flammability rating | V-2 | Contact material | CuZn |
| Contact surface | tinned | Layer structure of solder connection | 1.5...3 μm Ni / 4...6 μm Sn |
| Storage temperature, min. | -40 °C | Storage temperature, max. | 70 °C |
| Operating temperature, min. | -50 °C | Operating temperature, max. | 100 °C |
| Temperature range, installation, min. | -25 °C | Temperature range, installation, max. | 100 °C |

Conductors suitable for connection

| | |
|---|----------------------|
| Clamping range, min. | 0.13 mm ² |
| Clamping range, max. | 2.5 mm ² |
| Wire connection cross section AWG, min. | AWG 26 |
| Wire connection cross section AWG, max. | AWG 14 |
| Solid, min. H05(07) V-U | 0.5 mm ² |
| Solid, max. H05(07) V-U | 2.5 mm ² |
| Flexible, min. H05(07) V-K | 0.5 mm ² |
| Flexible, max. H05(07) V-K | 2.5 mm ² |
| w. plastic collar ferrule, DIN 46228 pt 4, min. | 0.5 mm ² |
| w. plastic collar ferrule, DIN 46228 pt 4, max. | 2.5 mm ² |

Creation date January 20, 2023 10:02:41 AM CET

TOP1.5GS8/90 7 2STI OR

Weidmüller Interfaces GmbH & Co. KG

Postfach 3030

32760 Detmold

Tel. +49 5231 14-0

Fax. +49 5231 14-2083

info@weidmueller.com

www.weidmueller.com

Technical data

w. wire end ferrule, DIN 46228 pt 1, min. 0.5 mm²w. wire end ferrule, DIN 46228 pt 1, max. 2.5 mm²

Plug gauge in accordance with EN 60999 a x b; ø 2.4 mm x 1.5 mm

Clampable conductor

| | | |
|--|------------------------------|----------------------------|
| Cross-section for conductor connection | Type | fine-wired |
| | nominal | 0.5 mm ² |
| wire end ferrule | Stripping length | nominal 12 mm |
| | Recommended wire-end ferrule | H0.5/16 OR |
| | Stripping length | nominal 10 mm |
| | Recommended wire-end ferrule | H0.5/10 |
| Cross-section for conductor connection | Type | fine-wired |
| | nominal | 0.75 mm ² |
| wire end ferrule | Stripping length | nominal 12 mm |
| | Recommended wire-end ferrule | H0.75/16 W |
| | Stripping length | nominal 10 mm |
| | Recommended wire-end ferrule | H0.75/10 |
| Cross-section for conductor connection | Type | fine-wired |
| | nominal | 1 mm ² |
| wire end ferrule | Stripping length | nominal 12 mm |
| | Recommended wire-end ferrule | H1.0/16D R |
| | Stripping length | nominal 10 mm |
| | Recommended wire-end ferrule | H1.0/10 |
| Cross-section for conductor connection | Type | fine-wired |
| | nominal | 1.5 mm ² |
| wire end ferrule | Stripping length | nominal 10 mm |
| | Recommended wire-end ferrule | H1.5/10 |
| | Stripping length | nominal 12 mm |
| | Recommended wire-end ferrule | H1.5/16 R |
| Cross-section for conductor connection | Type | fine-wired |
| | nominal | 2.5 mm ² |
| wire end ferrule | Stripping length | nominal 10 mm |
| | Recommended wire-end ferrule | H2.5/10 |

Reference text Length of ferrules is to be chosen depending on the product and the rated voltage., The outside diameter of the plastic collar should not be larger than the pitch (P)

Rated data acc. to IEC

| | | | |
|---|------------------------|---|-------------------|
| tested acc. to standard | IEC 60664-1, IEC 61984 | Rated current, min. number of poles (Tu=20°C) | 24 A |
| Rated current, max. number of poles (Tu=20°C) | 19 A | Rated current, min. number of poles (Tu=40°C) | 21 A |
| Rated current, max. number of poles (Tu=40°C) | 16 A | Rated voltage for surge voltage class / pollution degree II/2 | 1,000 V |
| Rated voltage for surge voltage class / pollution degree III/2 | 630 V | Rated voltage for surge voltage class / pollution degree III/3 | 400 V |
| Rated impulse voltage for surge voltage class/ pollution degree II/2 | 4 kV | Rated impulse voltage for surge voltage class/ pollution degree III/2 | 4 kV |
| Rated impulse voltage for surge voltage class/ contamination degree III/3 | 4 kV | Short-time withstand current resistance | 3 x 1s with 120 A |

Creation date January 20, 2023 10:02:41 AM CET

TOP1.5GS8/90 7 2STI OR

Weidmüller Interfaces GmbH & Co. KG

Postfach 3030

32760 Detmold

Tel. +49 5231 14-0

Fax. +49 5231 14-2083

info@weidmueller.com

www.weidmueller.com

154685-1501716

Technical data

Rated data acc. to CSA

Institute (CSA)



Certificate No. (CSA)

www.weidmueller.com

Rated voltage (Use group B / CSA) 300 V

Rated voltage (Use group D / CSA) 300 V

Rated current (Use group B / CSA) 10 A

Rated current (Use group D / CSA) 10 A

Wire cross-section, AWG, min. AWG 26

Wire cross-section, AWG, max. AWG 14

Reference to approval values

Specifications are maximum values, details - see approval certificate.

Rated data acc. to UL 1059

Rated voltage (Use group B / UL 1059) 300 V

Rated voltage (Use group D / UL 1059) 300 V

Rated current (Use group B / UL 1059) 10 A

Rated current (Use group D / UL 1059) 10 A

Wire cross-section, AWG, min. AWG 26

Wire cross-section, AWG, max. AWG 14

Packing

Packaging

Box

VPE length

161 mm

VPE width

108 mm

VPE height

55 mm

Classifications

ETIM 6.0

EC002643

ETIM 7.0

EC002643

ETIM 8.0

EC002643

ECLASS 9.0

27-44-04-01

ECLASS 9.1

27-44-04-01

ECLASS 10.0

27-44-04-01

ECLASS 11.0

27-46-01-01

ECLASS 12.0

27-46-01-01

Important note

IPC conformity

Conformity: The products are developed, manufactured and delivered according international recognized standards and norms and comply with the assured properties in the data sheet resp. fulfill decorative properties in accordance with IPC-A-610 "Class 2". Further claims on the products can be evaluated on request.

Notes

- Additional variants on request
- Rated current related to rated cross-section & min. No. of poles.
- Wire end ferrule without plastic collar to DIN 46228/1
- Wire end ferrule with plastic collar to DIN 46228/4
- Crimp form A for wire end ferrules with PZ 6/5 crimping tool are recommended for the largest cable sizes.
- P on drawing = pitch
- Rated data refer only to the component itself. Clearance and creepage distances to other components are to be designed in accordance with the relevant application standards.
- Long term storage of the product with average temperature of 50 °C and average humidity 70%, 36 months

TOP1.5GS8/90 7 2STI OR

Weidmüller Interfaces GmbH & Co. KG

Postfach 3030

32760 Detmold

Tel. +49 5231 14-0

Fax. +49 5231 14-2083

info@weidmueller.com

www.weidmueller.com

Technical data

Approvals

Approvals



ROHS

Conform

Downloads

| | |
|------------------|---|
| Engineering Data | CAD data – STEP |
| Engineering Data | WSCAD |
| Catalogues | Catalogues in PDF-format |
| Brochures | FL DRIVES EN FL ANALO.SIGN.CONV. EN MB DEVICE MANUF. EN FL DRIVES DE FL BUILDING SAFETY EN FL APPL LED LIGHTING EN FLIndustr.CONTROLS EN FL MACHINE SAFETY EN FL HEATING ELECTR EN FL APPL INVERTER EN FL_BASE_STATION_EN FL ELEVATOR EN FL POWER SUPPLY EN FL 72H SAMPLE SER EN PO OMNIMATE EN PO OMNIMATE EN |

TOP1.5GS8/90 7 2STI OR

Weidmüller Interfaces GmbH & Co. KG

Postfach 3030

32760 Detmold

Tel. +49 5231 14-0

Fax. +49 5231 14-2083

Drawings

Dimensional drawing info@weidmueller.com

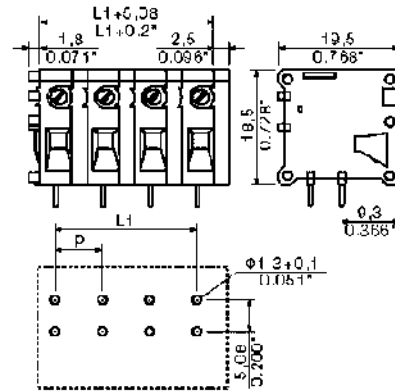

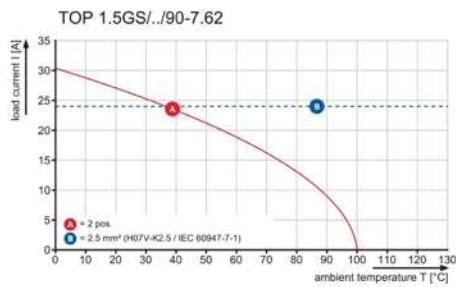

Graph



MASSE OHNE TOLERANZ SIND KEINE PRUEFMASSE
 DIMS. WITHOUT TOLERANCE ARE NOT CONTROL DIMS.

DIE DEUTSCHE VERSION IST VERBINDLICH
 THE GERMAN VERSION IS BINDING

Technical Data

| | | |
|---|-----------------------|----------------------|
| Rev. | | |
| Material data | | |
| Insulation material type | | PA 66 |
| Insulation material colours | | S 33230 |
| Insulation material flammability class | UL94 | V-2 |
| Insulation resistance | MOhm | 10 ³ |
| Contact base material | | CuZn |
| Contact plating (mating end) | | Tin-plated |
| Contact plating (solder end) | | n/a |
| System characteristic values together with counterpart | | |
| Pitch P | mm/inch | 7.62 / 0.3 |
| Number of rows | | 1 |
| Dielectric strength (r.m.s withstand voltage) | kV | 2.5 |
| Conductor connection methode | | TOP connection |
| Plug in force (max.) | N/pole | n/a |
| Pull out force (max.) | N/pole | n/a |
| Through resistance (typical) | mOhm | 0.9 |
| Operating temperature range | °C | -20....+100 |
| Degree of protection acc. to VDE 0106 (plugged/unplugged) | | finger safe |
| Degree of protection acc. to DIN EN 60529 (plugged/unplugged) | | IP20 |
| Solder pin length L | mm/inch | 3.5 |
| PCB hole diameter D (wave soldering) | mm/inch | 1.3 |
| PCB hole diameter D (reflow soldering) | mm/inch | n/a |
| Resistance to soldering heat acc. to DIN IEC 60512-6 | °C/sec | 260/10 |
| Resistance to soldering heat acc. to EN 61760-1 | °C/sec | n/a |
| Solderability classification acc. to EN 61760-1 | | n/a |
| Solder connection type | | wave soldering |
| Solder pin diameter d (max.) | mm/inch | 1.28/0.05 |
| Application notes | | |
| Coding possibility | yes/no | no |
| Joinable without loss of pitch | yes/no | no |
| Manual assembly of modules | yes/no | yes |
| Max. number of poles | n | 12 |
| IEC 664-1 / VDE0110 (4.97) rated data | | |
| Rated cross section acc. to EN 60999 | mm ² | 1.5 |
| Rated current @ 20°C ambient (together with) | A | 16 |
| Rated current @ 40°C ambient (together with) | A | xxx |
| Overvoltage category / Pollution degree | | |
| Rated voltage | V | 500 630 1000 |
| Rated impulse voltage | kV | 6.0 6.0 6.0 |
| UL 1059 rated data  File No.: E60693 | | |
| Rated voltage | V | 300 |
| Rated current | A | 10 |
| Clamping range | mm ² / AWG | 0.5...1.5/26..14 |
| CSA C22.2 rated data  File No.: LR12400 | | |
| Rated voltage | V | 300 |
| Rated current | A | 10 |
| Clamping range | mm ² / AWG | 0.5.....1.5/26....14 |
| Packaging | | |
| | | carton |
| Downloads | | |
| | | www.weidmueller.de |

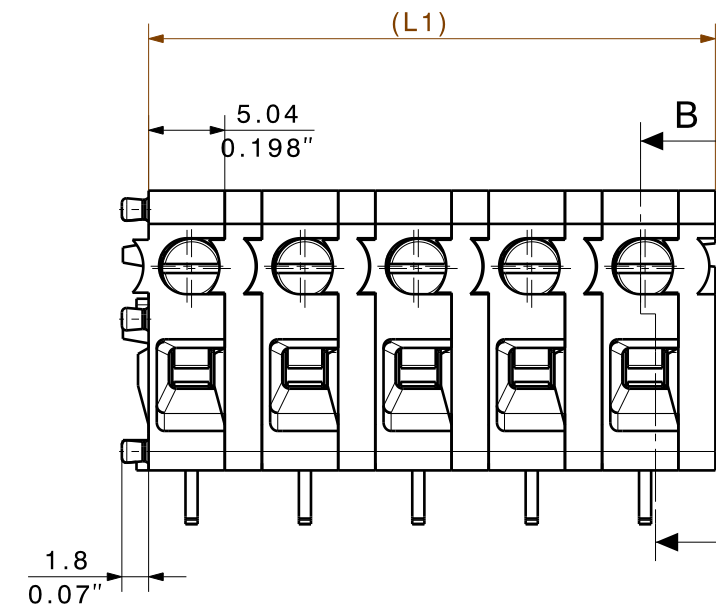
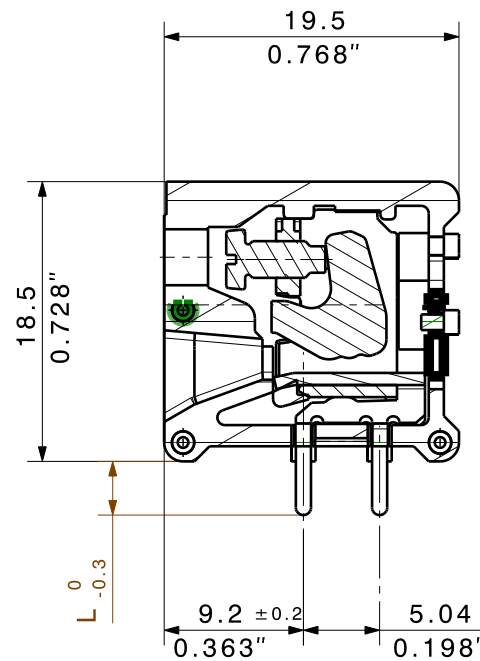

Drilling Diagram

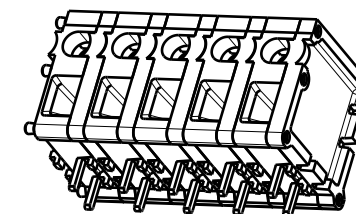
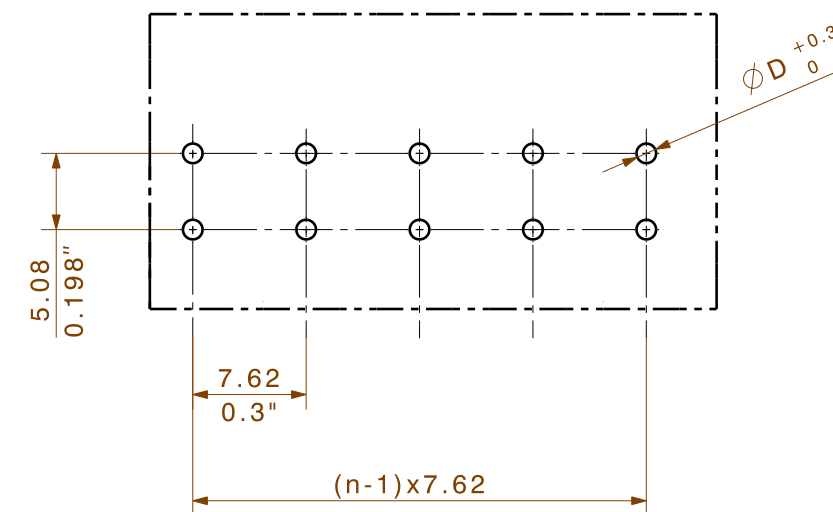

| | | |
|----|---------|-----------|
| 12 | 91,44 | 3,600 |
| 11 | 83,82 | 3,300 |
| 10 | 76,20 | 3,000 |
| 9 | 68,58 | 2,700 |
| 8 | 60,96 | 2,400 |
| 7 | 53,34 | 2,100 |
| 6 | 45,72 | 1,800 |
| 5 | 38,10 | 1,500 |
| 4 | 30,48 | 1,200 |
| 3 | 22,86 | 0,900 |
| 2 | 15,24 | 0,600 |
| 1 | 7,62 | 0,300 |
| n | L1 [mm] | L1 [Inch] |

02 Zeichnung komplett überarbeitet

- 1) Without locking latches
- 2) Sum of ambient temperature and temperature rise
- 3) Recommendation for manual assembly
- 4) Recommendation for automatic assembly
- 5) Recommendation for wave soldering
- 6) Recommendation for reflow soldering
- 7) Referred to rated cross section and minimum pole number

n.a. = not applicable

Subject to technical changes

For the mounting of PCBs, it should be noted that the rated data stated here relates only to the PCB components alone. The necessary creepage and clearance paths must be observed in connection with the respective applicant in accordance to IEC 664 / VDE 0110. The current-carrying capacity and pitch tolerance is to be determined according to DIN IEC 326 part 3 very fine.

Weidmüller PCB components are tested to the DIN EN 61984 standard, and are valid for its field of application. Provided that the components are used to the intended purpose, all requirements with respect to the occurring of electrical, mechanical, thermic and corrosive stress will be satisfied.

| | | | | |
|---|-------------|---|-------------------------------|---------------------------------|
| METRIC TOLERANCES: X. = ±0.3 X.X = ±0.1 X.XX = ±0.05 | | 35928/5 05.09.06 KRUG_M 01 | CAT.NO.: C 33230 02 | |
| MODIFICATION | |  | | DRAWING NO. SHEET 3 OF 4 SHEETS |
| METRIC/INCH DIMENSIONS | DATE | NAME | TOP 1.5 GS /90 2STI | |
| SCALE: 2:1 | DRAWN | HEINEL_M | | |
| SUPERSEDES: | RESPONSIBLE | KRUG_M | | |
| SUPERSEDED BY: . | CHECKED | HECKERT_M | PRODUCT FILE: | |
| | APPROVED | GUENTHER_W | | |

WEITERGABE SOWIE VERVIELFÄLTIGUNG DIESER DOKUMENTS, VERWERTUNG UND MITTEILUNG SEINER INHALTS SIND VERBOTEN, SOWEIT NICHT AUSDRUECKLICH GESTATET. ZUWIDERHANDLUNGEN VERPFLICHTEN ZU SCHADENERSATZ. ALLE RECHTE FUER DEN FALL DER PATENT-, GEBRAUCHSMUSTER- ODER GESCHMACKSMUSTEREINTRAGUNG VORBEHALTEN. THE REPRODUCTION, DISTRIBUTION AND UTILIZATION OF THIS DOCUMENT AS WELL AS THE COMMUNICATION OF ITS CONTENTS TO OTHERS WITHOUT EXPLICIT AUTHORIZATION IS PROHIBITED. OFFENDERS WILL BE HELD LIABLE FOR THE PAYMENT OF DAMAGES. ALL RIGHTS RESERVED IN THE EVENT OF THE GRANT OF A PATENT, UTILITY MODEL OR DESIGN.

Recommended wave soldering profiles

Weidmüller Interface GmbH & Co. KG
 Klingenbergstraße 16
 D-32758 Detmold
 Germany
 Fon: +49 5231 14-0
 Fax: +49 5231 14-292083
 www.weidmueller.com

Single Wave:



Double Wave:

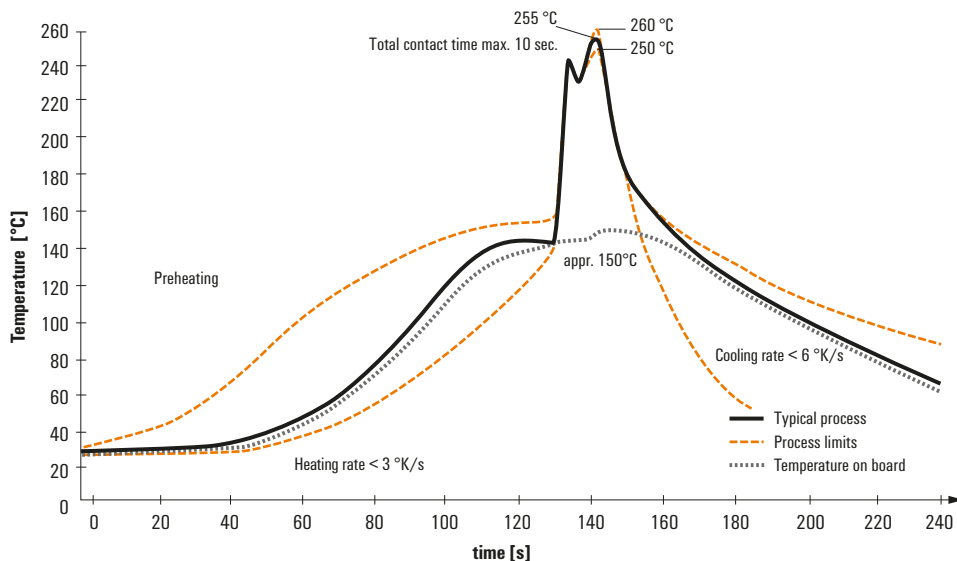

Wave soldering profiles

Wired connection elements should be processed in accordance with the DIN EN 61760-1 standard. We have included two recommendations for practical wave soldering profiles, with which Weidmüller PCB terminals and connectors are qualified.

When choosing a suitable profile for your application, the following factors also need to be considered:

- PCB thickness
- Proportion of Cu in the layers
- Single/double-sided assembly
- Product range
- Heating and cooling rates

The single and double wave profiles each indicate the recommended operating range, including the maximum soldering temperature of 260°C. In practice, the maximum soldering temperature is quite often well below the above maximum profile.