

Subminiature Fuse, 8.5 mm, Time-Lag T, 250 VAC, 63 VDC



IEC 60127-3 · 250VAC · Time-Lag T

Description

- Directly solderable on printed circuit boards
- Low Breaking Capacity

Approvals and Compliances**Applications**

- Primary Protection on PCB
- Power Supply Adapter for e.g. laptops
- SMPS (Switching Mode Power Supply) for TV's and DVD's

References

[Packaging Details](#)

Corresponding Fuseholder [FMS \(250V\)](#)

Fuse Kit [Fuse Kit MST250 / MSF 250](#)

Weblinks

[pdf datasheet](#), [html-datasheet](#), [General Product Information](#), [Packaging details](#), [Distributor-Stock-Check](#), [Detailed request for product](#)

Technical Data

Rated Voltage	250VAC, 63 VDC
Rated current	0.05 - 6.3A
Breaking Capacity	35A - 63A
Characteristic	Time-Lag T
Mounting	PCB,THT
Admissible Ambient Air Temp.	-55 °C to 125 °C
Climatic Category	55/125/21 acc. to IEC 60068-1
Material: Housing	Thermoplastic, UL 94V-0
Material: Terminals	Tin-Plated Copper
Unit Weight	0.53 g
Storage Conditions	0 °C to 40 °C, max. 70% r.h.
Product Marking	 Type, Rated current, Rated Voltage, Characteristic, Approvals







Soldering Methods	Wave Soldering Profile
Solderability	235 °C / 2 sec acc. to IEC 60068-2-20, Test Ta
Resistance to Soldering Heat	260 °C / 10 sec acc. to IEC 60068-2-20, Test Tb
Current Carrying Capacity	acc. to EIA/IS-722, Test 4.3.3
Moisture Resistance Test	MIL-STD-202, Method 106E (50 cycles in a temp./mister chamber)
Terminal Strength	Tensile load min. 9 N (acc. to EIA/IS-722, Test 4.5.1)
Case Resistance	acc. to EIA/IS-722, Test 4.7 >100 MΩ (between leads and body)
Mechanical Shock	MIL-STD-202, Method 213B (Shock 50g, half sine wave, 11 ms)
Vibration, High Frequency	Shock 20 gn, 20 min, 10-2 kHz, 12 cyc. (acc. to EIA/IS-722, Test 4.10)
Resistance to Solvents	MIL-STD-202, Method 215A
Flammability	UL 94V-0 (acc. to EIA/IS-722, Test 4.12)

Approvals and Compliances

Detailed information on product approvals, code requirements, usage instructions and detailed test conditions can be looked up in [Details about Approvals](#)



Approvals

The approval mark is used by the testing authorities to certify compliance with the safety requirements placed on electronic products.
 Approval Reference Type: MST 250

Approval Logo	Certificates	Certification Body	Description
	VDE Approvals	VDE	VDE Certificate Number: 40002080
	VDE Approvals	VDE	VDE Certificate Number: 40002080
	UL Approvals	UL	UL File Number: E41599
	CQC Approvals	CQC	CQC File Number:
	KTL Approvals	KTL	Korea Testing Laboratory
	METI Approvals	METI	Japan Electrical Safety and Environment technology Laboratories

Product standards

Product standards that are referenced

Organization	Design	Standard	Description
	Designed according to	UL 248-14	Low voltage fuses - Part 14: Additional fuses
	Designed according to	CSA22.2 No. 248.14	Low-Voltage Fuses - Part 14: Supplemental Fuses





Application standards

Application standards where the product can be used

Organization	Design	Standard	Description
	Designed for applications acc.	IEC/UL 60950	IEC 60950-1 includes the basic requirements for the safety of information technology equipment.

Compliances

The product complies with following Guide Lines

Identification	Details	Initiator	Description
	CE declaration of conformity	SCHURTER AG	The CE marking declares that the product complies with the applicable requirements laid down in the harmonisation of Community legislation on its affixing in accordance with EU Regulation 765/2008.
	RoHS	SCHURTER AG	EU Directive RoHS 2011/65/EU
	China RoHS	SCHURTER AG	The law SJ / T 11363-2006 (China RoHS) has been in force since 1 March 2007. It is similar to the EU directive RoHS.
	REACH	SCHURTER AG	On 1 June 2007, Regulation (EC) No 1907/2006 on the Registration, Evaluation, Authorization and Restriction of Chemicals 1 (abbreviated as "REACH") entered into force.

Dimension [mm]

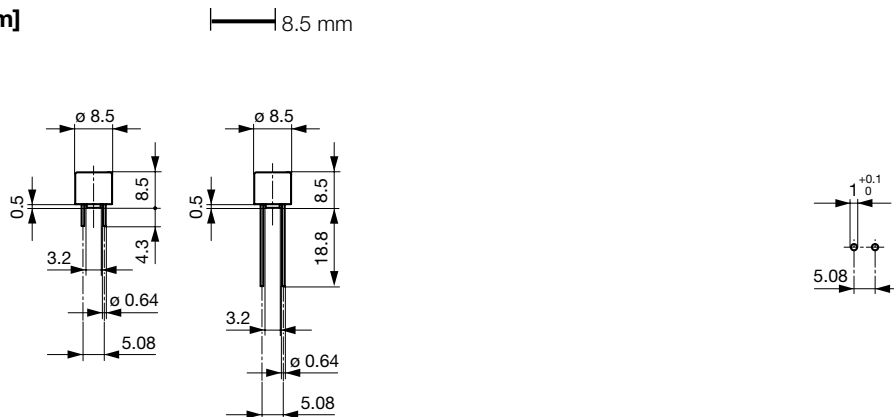

Drilling diagram

Pre-Arcing Time





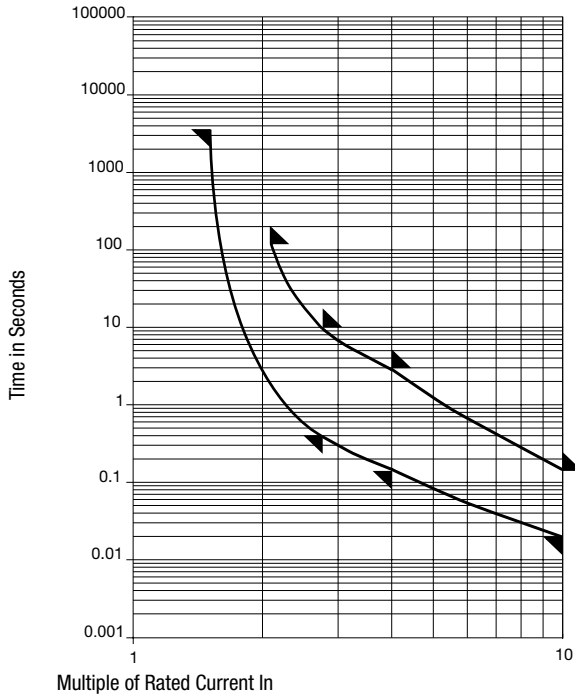

Rated Current In	1.5 x In min.	2.1 x In max.	2.75 x In min.	2.75 x In max.	4.0 x In min.	4.0 x In max.	10.0 x In min.	10.0 x In max.
0.05 A - 6.3 A	60 min	120 s	400 ms	10 s	150 ms	3 s	20 ms	150 ms

Time-Current-Curves



All Variants

Rated Current [A]	Rated Voltage [VAC]	Breaking Capacity	Voltage Drop 1.0 In max. [mV]	Voltage Drop 1.0 In typ. [mV]	Power Dissipation 1.5 In max. [mW]	Melting I²t 10.0 Intyp. [A²s]						S	L	T	Order Number
0.05	250	1)	550	415	155	0.03	•	•	•	•	•				0034.6602
0.05	250	1)	550	415	155	0.03	•	•	•	•	•				0034.6702
0.05	250	1)	550	415	155	0.03	•	•	•	•	•				0034.6802
0.063	250	1)	480	420	160	0.05	•	•	•	•	•				0034.6603
0.063	250	1)	480	420	160	0.05	•	•	•	•	•				0034.6703
0.063	250	1)	480	420	160	0.05	•	•	•	•	•				0034.6803
0.08	250	1)	400	360	165	0.06	•	•	•	•	•				0034.6604
0.08	250	1)	400	360	165	0.06	•	•	•	•	•				0034.6704
0.08	250	1)	400	360	165	0.06	•	•	•	•	•				0034.6804
0.1	250	1)	350	320	170	0.08	•	•	•	•	•				0034.6605
0.1	250	1)	350	320	170	0.08	•	•	•	•	•				0034.6705
0.1	250	1)	350	320	170	0.08	•	•	•	•	•				0034.6805
0.125	250	1)	300	270	180	0.12	•	•	•	•	•				0034.6606
0.125	250	1)	300	270	180	0.12	•	•	•	•	•				0034.6706
0.125	250	1)	300	270	180	0.12	•	•	•	•	•				0034.6806
0.16	250	1)	280	190	190	0.24	•	•	•	•	•				0034.6607
0.16	250	1)	280	190	190	0.24	•	•	•	•	•				0034.6707
0.16	250	1)	280	190	190	0.24	•	•	•	•	•				0034.6807
0.2	250	1)	260	150	200	0.35	•	•	•	•	•				0034.6608
0.2	250	1)	260	150	200	0.35	•	•	•	•	•				0034.6708
0.2	250	1)	260	150	200	0.35	•	•	•	•	•				0034.6808

Rated Current [A]	Rated Voltage [VAC]	Breaking Capacity	Voltage Drop 1.0 I _n max. [mV]	Voltage Drop 1.0 I _n typ. [mV]	Power Dissipation 1.5 I _n max. [mW]	Melting I ² t 10.0 I _n typ. [A ² s]							S	L	T	Order Number
0.25	250	1)	240	120	220	0.6	●		●	●	●	●				0034.6609
0.25	250	1)	240	120	220	0.6	●		●	●	●	●	●			0034.6709
0.25	250	1)	240	120	220	0.6	●		●	●	●	●			●	0034.6809
0.315	250	1)	220	120	250	0.8	●		●	●	●	●	●			0034.6610
0.315	250	1)	220	120	250	0.8	●		●	●	●	●			●	0034.6710
0.315	250	1)	220	120	250	0.8	●		●	●	●	●			●	0034.6810
0.4	250	1)	200	110	280	1.1	●		●	●	●	●	●			0034.6611
0.4	250	1)	200	110	280	1.1	●		●	●	●	●			●	0034.6711
0.4	250	1)	200	110	280	1.1	●		●	●	●	●			●	0034.6811
0.5	250	1)	190	100	310	2.5	●		●	●	●	●	●			0034.6612
0.5	250	1)	190	100	310	2.5	●		●	●	●	●			●	0034.6712
0.5	250	1)	190	100	310	2.5	●		●	●	●	●			●	0034.6812
0.63	250	1)	180	90	360	4	●		●	●	●	●	●			0034.6613
0.63	250	1)	180	90	360	4	●		●	●	●	●			●	0034.6713
0.63	250	1)	180	90	360	4	●		●	●	●	●			●	0034.6813
0.8	250	1)	160	80	430	8	●		●	●	●	●	●			0034.6614
0.8	250	1)	160	80	430	8	●		●	●	●	●			●	0034.6714
0.8	250	1)	160	80	430	8	●		●	●	●	●			●	0034.6814
1	250	1)	140	70	500	12	●		●	●	●	●	●			0034.6615
1	250	1)	140	70	500	12	●		●	●	●	●			●	0034.6715
1	250	1)	140	70	500	12	●		●	●	●	●			●	0034.6815
1.25	250	1)	130	70	600	15	●		●	●	●	●	●			0034.6616
1.25	250	1)	130	70	600	15	●		●	●	●	●			●	0034.6716
1.25	250	1)	130	70	600	15	●		●	●	●	●			●	0034.6816
1.6	250	1)	120	60	730	30	●		●	●	●	●	●			0034.6617
1.6	250	1)	120	60	730	30	●		●	●	●	●			●	0034.6717
1.6	250	1)	120	60	730	30	●		●	●	●	●			●	0034.6817
2	250	1)	100	60	870	34	●		●	●	●	●	●			0034.6618
2	250	1)	100	60	870	34	●		●	●	●	●			●	0034.6718
2	250	1)	100	60	870	34	●		●	●	●	●			●	0034.6818
2.5	250	1)	100	50	1000	55	●		●	●	●	●	●			0034.6619
2.5	250	1)	100	50	1000	55	●		●	●	●	●			●	0034.6719
2.5	250	1)	100	50	1000	55	●		●	●	●	●			●	0034.6819
3.15	250	1)	100	50	1200	76	●		●	●	●	●	●			0034.6620
3.15	250	1)	100	50	1200	76	●		●	●	●	●			●	0034.6720
3.15	250	1)	100	50	1200	76	●		●	●	●	●			●	0034.6820
4	250	2)	100	50	1400	80	●		●	●	●	●	●			0034.6621
4	250	2)	100	50	1400	80	●		●	●	●	●			●	0034.6721
4	250	2)	100	50	1400	80	●		●	●	●	●			●	0034.6821
5	250	3)	-	50	-	230		●	●	●		●	●			0034.6622
5	250	3)	-	50	-	230		●	●	●		●			●	0034.6722
5	250	3)	-	50	-	230		●	●	●		●			●	0034.6822
6.3	250	3)	-	45	-	360		●	●			●	●			0034.6623
6.3	250	3)	-	45	-	360		●	●			●			●	0034.6723
6.3	250	3)	-	45	-	360		●	●			●			●	0034.6823

Most Popular.







Availability for all products can be searched real-time: <https://www.schurter.com/en/Stock-Check/Stock-Check-SCHURTER>

1) IEC: 35 A @ 250 VAC

1) UL: 35 A @ 250 VAC / 50 A @ 63 VDC

2) IEC: 10 In @ 250 VAC

2) UL: 10 In @ 250 VAC / 50 A @ 63 VDC

Rated Current [A]	Rated Voltage [VAC]	Breaking Capacity	Voltage Drop 1.0 In max. [mV]	Voltage Drop 1.0 In typ. [mV]	Power Dissipation 1.5 I _n max. [mW]	Melting I ² t 10.0 Intyp. [A ² s]								S	L	T	Order Number
-------------------	---------------------	-------------------	-------------------------------	-------------------------------	--	---	---	---	--	---	---	---	---	---	---	---	--------------

3) IEC: 10 In @ 250 VAC

3) UL: 10 In @ 250 VAC / 10 In @ 63 VDC

Packaging Unit	S =	L =	T =
	Plastic Bag (100 pcs.) short 4.3 mm	Bulk (100 pcs.) long 18.8 mm	Taped 36 cm Reel (750 pcs.) long 18.8 mm